



PANAMA CITY BEACH CITY COUNCIL AGENDA

NOTE: AT EACH OF ITS REGULAR OR SPECIAL MEETINGS, THE CITY COUNCIL ALSO SITS, EX-OFFICIO, AS THE CITY OF PANAMA CITY BEACH COMMUNITY REDEVELOPMENT AGENCY AND MAY CONSIDER ITEMS AND TAKE ACTION IN THAT LATTER CAPACITY.

MEETING DATE: DECEMBER 14, 2017
MEETING TIME: 6:00 P.M.

- I. CALL TO ORDER AND ROLL CALL
- II. INVOCATION- PASTOR RAMON DUVALL, BEACHSIDE FELLOWSHIP CHURCH
- III. PLEDGE OF ALLEGIANCE- CUB SCOUT TROUP 317
- IV. COMMUNITY ANNOUNCEMENTS
- V. APPROVAL OF THE MINUTES OF THE SPECIAL MEETING OF OCTOBER 12 AND THE REGULAR MEETING OF NOVEMBER 9, 2017
- VI. APPROVAL OF AGENDA, AND ADDITIONS OR DELETIONS
- VII. PRESENTATIONS- COUNCILMAN SOLIS
 - 1 BOYS AND GIRLS CLUB CIVIC ACHIEVEMENT AWARD
 - 2 CUB SCOUT TROUP 317 RECOGNITION
 - 3 EMPLOYEE MILESTONE PRESENTATIONS
- VIII. PUBLIC COMMENTS-REGULAR (NON-PUBLIC HEARINGS) & CONSENT ITEMS ONLY (LIMITED TO THREE MINUTES)
- IX. CONSENT AGENDA
 - 1 **"ARBOR DAY" PROCLAMATION.** *"A Proclamation designating January 6, 2018 as "Arbor Day" in Panama City Beach", and advising that 2,000 longleaf pines will be planted in the Conservation Park in honor of Arbor Day and allow the City to continue being designated as a "Tree City".*
 - 2 **ORDER 01-PL-18, LYNDELL PLACE PLAT APPROVAL.** *After having received testimony and reviewed the exhibits produced at the Quasi-Judicial Hearing held on this matter on November 9, 2017, the City Council orders that the subject request to subdivide the land is hereby GRANTED and the captioned plat of Lyndell Place is hereby APPROVED.*
 - 3 **RESOLUTION 18-22, BID AWARD- PORTABLE RESTROOM TRAILER & SERVICING UNIT.** *"A Resolution of the City of Panama City Beach, Florida, approving the purchase of a Portable Restroom Trailer and Servicing Unit from Ready 2 Go Restroom Trailers, LLC, for \$28,570; and providing an immediately effective date."*
 - 4 **RESOLUTION 18-27, BID AWARD- FRANK BROWN PARK BIG KIDS PLAYGROUND.** *"A Resolution of the City of Panama City Beach, Florida, approving an Agreement with J.A. Dawson & Company, Inc., in the amount of \$57,455.24 for the purchase of the GameTime Powerscape Citadel Tower for the Frank Brown Park Big Kids Playground; and providing an immediately effective date."*

- 5 **RESOLUTION 18-29, BID AWARD- PORTABLE GROUND PENETRATING RADAR.** "A Resolution of the City of Panama City Beach, Florida, approving the purchase of a Portable Ground Penetrating Radar from Green Equipment Company in the basic amount of \$13,650."
- 6 **RESOLUTION 18-30, WWTF REPAIR OF DIESEL POWERED ELECTRIC GENERATOR.** "A Resolution of the City of Panama City Beach, Florida, approving the purchase from TAW Power Systems, Inc. relating to the repair of a diesel powered electric generator at the City's Wastewater Treatment Facility in the total amount of \$14,740.54; and providing an immediately effective date."
- 7 **RESOLUTION 18-31, WWTF INFLUENT PIPING ADDITIONAL PIPE AND MATERIALS PURCHASES.** "A Resolution of the City of Panama City Beach, Florida, approving the purchase of additional piping replacement materials for the City's Wastewater Treatment Facility from 5 different vendors in the total amount of \$40,760.62 as more particularly set forth in the Resolution; and providing an immediately effective date."
- 8 **RESOLUTION 18-32, MASTER SERVICES AGREEMENT UTILITY ENGINEERING SERVICES, DEWBERRY ENGINEERS, TASK ORDER 2017-01, THOMAS DRIVE MANHOLE REPLACEMENT PROJECT.** "A Resolution of the City of Panama City Beach, Florida, approving Task Order #2017-01 to the Master Services Agreement with Dewberry Engineers, Inc. related to Engineering and Inspection Services for the replacement of 15 sewer manholes on Thomas Drive in an amount of \$21,350."
- 9 **RESOLUTION 18-33, BID AWARD- WWTF INFLUENT PIPING REPLACEMENT AND INSTALLATION.** "A Resolution of the City of Panama City Beach, Florida, approving an Agreement with Talcon Group, LLC, in the total amount of \$417,010 for the installation of replacement piping and fittings at the City's Wastewater Treatment Facility; and providing an immediately effective date."

X. REGULAR AGENDA - DISCUSSION/ACTION

- | NO. | OFFICIAL | ITEM |
|------------|-----------------|---|
| 1 | ML | ORDINANCE 1442, ANNUAL CAPITAL IMPROVEMENTS SCHEDULE, 2ND READING, <u>PUBLIC HEARING</u> AND ADOPTION. |
| 2 | AM | RESOLUTION 18-24, NOTICE OF INTENT TO USE UNIFORM METHOD OF COLLECTING NON-AD VALOREM FIRE PROTECTION SERVICES SPECIAL ASSESSMENTS, <u>PUBLIC HEARING.</u> |
| 3 | MG | APPOINTMENT OF TDC NON-COLLECTOR BOARD MEMBER. |
| 4 | MG | APPOINTMENT OF COUNCIL REPRESENTATIVES ON POLICE OFFICERS' AND FIREFIGHTERS' PENSION PLAN BOARDS. |
| 5 | MG | ORDINANCE 1445, AMENDING POLICE OFFICERS' RETIREMENT PLAN, AMENDING NORMAL RETIREMENT AGE AND DATE PROVISION, 1ST READING. |
| 6 | CL | RESOLUTION 18-21, GRANT AWARD FDOT PCBPD OUTREACH PROGRAM TO FIGHT AGAINST SPEED AND AGGRESSIVE DRIVING SC-18-13-10 AND BUDGET AMENDMENT #3. |
| 7 | MG | RESOLUTION 18-23, APPOINTING CITY TREASURER. |

- 8 KJ RESOLUTION 18-25, FEMA GRANT AWARD FOR GULF HIGHLANDS DRAINAGE IMPROVEMENT PROJECT, PHASE II, AND BUDGET AMENDMENT #4.
- 9* KJ RESOLUTION 18-34, CRA FRONT BEACH ROAD SEGMENT 2 CONSTRUCTION CONTRACT CHANGE ORDER #11 AND BUDGET AMENDMENT #5.
- 10 PC RESOLUTION 18-28, SUPPORT FOR SAFE ROUTE TO SCHOOL GRANT APPLICATION.
- 11 PC RESOLUTION 18-35, TEMPORARY ROAD CLOSURE FRONT BEACH ROAD FOR OCEAN VILLA CONDOMINIUMS PEDESTRIAN BRIDGE REPAIR AND MAINTENANCE.
- 12 AM ORDINANCE 1448, CHARTER AMENDMENT, COMPETITIVE BIDDING EXPENDITURES PER ANNUM, 1ST READING.
- 13 MG RESOLUTION 18-36, BEACH CHAIRS REGULATIONS.

* Action on this item is taken by both the City Council and the City of Panama City Beach Community Redevelopment Agency, jointly and concurrently.

XI. DELEGATES AND STAFF

1 DELEGATIONS. In accordance with the City Council's rules and procedures, residents or tax-collectors of the City (upon any subject of general or public interest), City employees (regarding his/her employment), and water and sewer customers (on matters related to the City's water and/or sewer system), may address the City Council under Delegations on items not on the printed agenda by filling out a speaker card. Speaker cards are located inside the Council meeting room and should be provided to the City Clerk. Please observe the time limit of three (3) minutes while speaking under Delegations. Delegations shall be limited to thirty (30) minutes unless extended by the Chair.

2 ATTORNEY REPORT.

3 CITY MANAGER REPORT.

4 COUNCIL COMMENTS.

5 ADJOURN.

JOHN REICHARD X
 PHIL CHESTER X
 JOSIE STRANGE X
 HECTOR SOLIS X
 MIKE THOMAS X

JOHN REICHARD X
 PHIL CHESTER X
 JOSIE STRANGE X
 HECTOR SOLIS X
 MIKE THOMAS X

I certify that the Council members listed above have been contacted and given the opportunity to include items on this agenda.

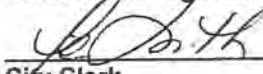
 12/8/17
 _____ Date
 City Clerk

I certify that the Council members listed above have been contacted and made aware of the items on this agenda.

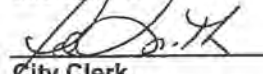
 12/8/17
 _____ Date
 City Clerk

IN AN EFFORT TO CONDUCT YOUR COUNCIL MEETINGS IN AN ORDERLY AND EXPEDIENT MANNER, WE RESPECTFULLY REQUEST THAT YOU WAIT UNTIL

THE CHAIR RECOGNIZES YOU TO SPEAK, THEN COME TO THE PODIUM AND STATE YOUR NAME AND ADDRESS FOR THE RECORD.

E-mailed to following interested parties on: 12/11/17, 1 P.M.

NEWS MEDIA

News Herald

Bullet

Channel 4

Channel 7

Channel 13

Comcast

WOW

WKGC

WLTG

Clear Channel

Powell Broadcasting

CONTACT

Tyra Jackson

Linda Lucas

News Dept

Newsroom

Brady Calhoun

Stefanie Bowden

Cil Schnitker

Tori Shay

A. D. Whitehurst

Production Director

Jeff Storey, GM

NOTE; COPIES OF THE AGENDA ITEMS ARE POSTED ON THE CITY'S WEBSITE WWW.PCBGOV.COM UNDER "AGENDA INFORMATION". THIS MEETING WILL BE LIVE-STREAMED ON THE CITY WEBSITE.

NOTICE IS GIVEN THAT ONE OR MORE MEMBERS OF OTHER CITY BOARDS MAY ATTEND AND SPEAK AT THIS MEETING.

If a person decides to appeal any decision made by the City Council with respect to any matter considered at the meeting, if an appeal is available, such person will need a record of the proceeding, and such person may need to ensure that a verbatim record of the proceeding is made, which record includes the testimony and evidence upon which the appeal is based. Sec. 286.0105, FS (1995)

DRAFT MINUTES

The Special Meeting of the City Council of the City of Panama City Beach, Florida, concerning the properties at 13623 and 13626 Front Beach Road, held on October 12, 2017.

ROLL
MAYOR MIKE THOMAS

COUNCILORS:
JOHN REICHARD
JOSIE STRANGE
PHIL CHESTER
HECTOR SOLIS

CITY MANAGER:
MARIO GISBERT
DEPUTY CITY CLERK:
JO SMITH
CITY ATTORNEY:
AMY MYERS

Mayor Thomas called the Special Meeting to order at 3:00 P.M. with all Council members, City Manager, Deputy City Clerk and City Attorney present. Also present was Land Attorney, Mr. David Theriaque.

The invocation and Pledge of Allegiance was given by Councilman Solis.

ITEM 1 REHEARING OF THE ORDER OF THE PLANNING BOARD APPROVING A LARGE-SITE DEVELOPMENT ON PROPERTY LOCATED AT 13623 AND 13626 FRONT BEACH ROAD, PUBLIC HEARING.

Attorney Theriaque explained the ground rules for the Quasi-Judicial Rehearing. For the purposes of the Rehearing, the four individuals who appealed the Order must demonstrate that they had standing to qualify as adversely affected parties. The Council would make the determination if they had standing. He then asked the Council members for their Jennings Disclosures. The Council members gave their Disclosures. Then the witnesses were sworn.

Mr. Peter Fischetti, 308 Tarpon St. Mr. Fischetti said his standing was the impact that the development would have on his family, neighbors, safety and lifestyle. He mentioned the danger of the additional traffic on the narrow streets since Bid-A-Wee had no sidewalks or curbs. Councilman Reichard said he understood that Bid-A-Wee did not have a typical Homeowners Association and Mr. Fischetti said he was speaking as an individual. There were no further Council member questions. **Councilman Solis made the motion that Mr. Fischetti had standing. Second was by Councilman Reichard and the motion passed by unanimous roll call vote recorded as follows:**

Councilman Reichard	Aye
Councilman Chester	Aye
Councilwoman Strange	Aye
Councilman Solis	Aye
Mayor Thomas	Aye

Mr. Howard (Stan) LeCain, 14104 Pelican Street. Mr. LeCain said he was already affected by tourist traffic passing through the subdivision and concerned with his safety while riding his bicycle and the safety of families with children in the neighborhood. Mr. Jason Alley, developer, had no questions. **Councilwoman Strange made the motion that Mr. LeCain had standing. Second was by Councilman Solis and the motion passed by unanimous roll call vote recorded as follows:**

Councilman Reichard	Aye
Councilman Chester	Aye
Councilwoman Strange	Aye
Councilman Solis	Aye
Mayor Thomas	Aye

Mr. Jim Smith, 506 Tarpon Street. Mr. Smith said he would be affected by the increased traffic and his home being shaded by the height of the buildings. He said they were not opposed to the development but did oppose any access to Crane Street by the development. **Councilwoman Strange made the motion that Mr. Smith had standing. Second was by Councilman Reichard and the motion passed by unanimous roll call vote recorded as follows:**

Councilman Reichard	Aye
Councilman Chester	Aye
Councilwoman Strange	Aye
Councilman Solis	Aye
Mayor Thomas	Aye

Mr. Bill Caravello, 407 Dolphin Street. Mr. Caravello said his lifestyle would be affected by the noise and traffic. He said Dolphin was a sidestreet of Crane and would receive the additional traffic. **Councilman Solis made the motion that Mr. Caravello had standing. Second was by Councilwoman Strange and the motion passed by unanimous roll call vote recorded as follows:**

Councilman Reichard	Aye
Councilman Chester	Aye
Councilwoman Strange	Aye
Councilman Solis	Aye
Mayor Thomas	Aye

Mr. Leonard said this location was the old Fiesta site on the south side and the old go cart track and arcade on the north side property. The City had paid to demolish the buildings years ago, and once the bank assumed the properties, the City was repaid for the costs. He said the site was 13.28 acres, proposed for 588 units and a prior Development Agreement expired in 2013. The FLUM designation was Tourist, zoning CH, with the southside of Front Beach Road as FBO-4 which allowed height of 150' and with incentives 220'. For the northside property, it was FBO-2 which allowed height of 45' and with incentives 65'. The Planning Board heard the requests on August 14, 2017, and recommended approval five to one (5-1). Mr. Leonard confirmed the notices for the meeting had been timely filed. He then entered the Agenda Packet into the record which included the Minutes of the Planning Board meeting, the Appeal letter, the Planning Board Order, support letters, opposition letters, application, Staff Report, and Height Incentive application and Staff Report.

Mayor Thomas asked Mr. Theriaque if the two issues should be considered separately and Mr. Theriaque said that would be appropriate for the record. Mayor Thomas invited testimony from the adversely affected individuals, reminding that this portion of the meeting did not involve the Height Incentives.

Mr. Fischetti said he opposed any access to Crane Street because the Bid-A-Wee streets were not designed for the additional volume of traffic. Mr. Theriaque asked Mr. Alley if he had any questions and there were none

Mr. LeCain referred to their letter with the nine points of opposition. He emphasized that the residents were not against the development. However, they did oppose the development using the Bid-A-Wee neighborhood as ingress and egress. He spoke at length and identified sections of the LDC which supported their opposition. Mr. Alley asked Mr. LeCain if he had visited the Splash development as their parking garage exited upon a residential street. Mr. LeCain said he had not. Mr. Alley asked if Mr. LeCain would object if the development was all residential and Mr. LeCain said he could not respond without conferring with the group and would have to see the design before answering. Mr. Alley had no further questions.

Mr. Smith explained the community's HOA and that he did not represent the HOA. He said he was concerned with safety due to the narrow streets, no sidewalks, no curbs, and increased traffic. He spoke at length concerning the impact to their lifestyle. Mr. Alley asked Mr. Smith if any development on that site would increase traffic and Mr. Smith responded affirmatively.

There was no further testimony from the adversely affected parties.

Mr. James Alley, developer, said this was a bubble plan to establish the parameters of the development. He said they understood everyone's concern about traffic and he reminded that they would pay their Proportionate Share to improve traffic. He said Crane Street would be used for the residential and multi-family portions of the development. He displayed an illustration of the bubble plan. Mr. Alley said they had met with the Bid-A-Wee residents and discussed the gate which previously had not been in the plans.

Councilman Solis asked if the residential cottages would be sold. Mr. Alley responded affirmatively and the owners could rent them if desired. Councilwoman Strange asked where the heavy construction equipment would travel to reach the site. Mr. Alley said the project would be built in phases with a laydown area on site, and there was no reason for the trucks to travel Crane Street. He reminded that only the condominiums and cottages would have access to Crane Street.

Councilman Reichard mentioned the gate on Crane Street and what plans were made if the gate malfunctioned. Mr. Alley said the residential and multi-family visitors could exit onto Front Beach Road if the gate malfunctioned. He showed the three gates which would limit the access to Crane Street.

Councilman Solis asked who would own the internal roads. Mr. Alley responded that the HOA would own the residential roads in the rear of the site. He discussed the parking garage which could only be entered via Front Beach Road. Councilman Solis spoke of the fears of plans and original intent being changed later. Mr. Alley said he understood but could not speculate what might occur in the future.

Councilman Reichard asked how many units would be in the residential portion of the development and Mr. Alley said sixty (60) units and only they would use the gate at Crane Street.

The Mayor asked if the other Council members had any further questions and there were none.

Mr. LeCain asked Mr. Alley about the risk of the visitors using the hotel parking garage exiting via Crane Street when Front Beach Road was congested. Mr. Alley said the parking garage could only exit to Front Beach Road. Mr. LeCain asked about the other parking areas and Mr. Alley identified each area and the number of parking spaces in each.

Mr. Fischetti asked if all sixty units exiting onto Crane could be short-term rentals. Mr. Alley responded affirmatively based on zoning. Mr. Fischetti questioned the residential and multi-family sections being separated from the commercial areas via a wall. Mr. Alley said within the LDC, there was a requirement for the developer to increase flow within their project. However, if the residents wanted a wall and the City would approve a wall, he said they might not object to that change. Mr. Fischetti said what the residents really wanted was no access onto Crane Street.

Mr. Caravello asked how visitors in the residential areas would access the beach and Mr. Alley explained the walkways and a planned walkover. Mr. Alley said that this was a conceptual plan and some questions he could only speculate about answers.

Mr. Smith asked if the people using the parking tower could access the residential areas in the rear of the development. Mr. Alley said they could not.

Mr. LeCain asked why not rezone the residential areas as Residential instead of Commercial. Mr. Alley said why and Mr. LeCain mentioned the risk in future commercial development accessing the neighborhood. He said if residential, they would not have a say in the access to Bid-A-Wee. There were no further questions from the adversely affected parties.

Mr. Theriaque asked Mr. Alley details about the second gate. Mr. Alley said it was originally planned for key card access but could be changed to a permanent barrier to satisfy the residents. However, this would make Crane Street the only access to the residential section of the development.

Mr. Gisbert asked about access by emergency equipment and fire trucks. Mr. Alley said it would be a big issue for the emergency equipment accessing the residential areas with a permanent barrier.

Mr. Theriaque asked the affected parties if they had further evidence to present. Mr. LeCain said they had no additional evidence but remained concerned that they had no assurances that future commercial development would not access the neighborhood. Mayor Thomas opened the Public Comments section of the meeting at 4:30 P.M.

Mr. Ken Johnson, 135 Sea Oats Drive. Mr. Johnson questioned three exits onto Crane Street for the residential area but only two exits for the hotel onto Front Beach Road.

Mr. Harry Atkinson, 111 Sea Oats Drive. Mr. Atkinson said those residential units could not be short-term rentals because they were north of Bay Avenue.

Mr. Tod Ingram questioned the red on the plan and what it meant as he had clients in that area.

Mr. Howard Brackett, 13800 Pelican Street. Mr. Brackett commented about stop signs and the additional traffic. He mentioned dust and dirt from the development as well as losing their quality of life.

Mr. J. Hornsby, 14102 Pelican Street. Mr. Hornsby asked about the infrastructure of the new development.

Ms. Colleen Swab, California Cycles. Ms. Swab questioned why her property was noted in red on the plans and asked for an explanation.

Mr. Juddy Stephenson, Millcole. Mr. Stephenson said his street already had a traffic problem and asked the Council to consider the east-west streets as this would hurt the community.

Mr. Tom Evans, 504 Lantana. Mr. Evans commented on the impact of increased noise levels in the residential neighborhoods. He was concerned about the additional noise from air conditioners, mechanical equipment, etc., exceeding the sound limit on a regular basis. He asked the Council to send the matter back to the Planning Board for their consideration on the noise matter, and if not, ask that current readings be taken to establish a baseline for future readings from the development.

With no further comments, the Public Comments section was closed at 4:41 P.M.

Mr. Leonard said the red on the map was Commercial High Intensity and there were no rezonings associated with the request. In response to questions from Ms. Myers, Mr. Leonard confirmed there were no Conditional Uses or deviations associated with the request. She asked him if he felt comfortable from a planning perspective if the permanent barrier limiting the residential traffic to only Crane Street would still allow traffic flow. Mr. Leonard responded yes. Ms. Myers asked him from a Code Enforcement perspective if the permanent barrier made sense to address the traffic issues. Mr. Leonard said yes.

Mr. Smith said the original request had three accesses to Crane Street, and asked if this had been changed. Mayor Thomas said the developer was asking for three accesses. He had no further comments.

Mr. Alley said they were not asking for variances or deviations because they were fully compliant with the LDC. He said they would also continue an open dialogue with the residents of Bid-A-Wee as they progressed.

There were no Staff closing remarks.

Councilman Solis asked Mr. Leonard if the Large Site Development could be approved with conditions, and Mr. Leonard responded absolutely. Councilwoman Strange said she thought three accesses to Crane for sixty units was overkill. Councilman Chester and Councilman Reichard had no comments. Councilman Solis said with a development of this size, the Council would look to means to impact the neighborhood as little as possible. **Councilman Solis made the motion to approve the Large Site Development with no exits or entrances onto Crane Street. Second was by Councilwoman Strange and the motion passed by unanimous roll call vote recorded as follows:**

Councilman Reichard	Aye
Councilman Chester	Aye
Councilwoman Strange	Aye
Councilman Solis	Aye
Mayor Thomas	Aye

The Hearing was recessed at 4:50 P.M.

The Hearing was resumed at 5:00 P.M.

ITEM 2 REQUEST FOR HEIGHT INCREASE FOR PROPERTY LOCATED AT 13623 AND 13626 FRONT BEACH ROAD. PUBLIC HEARING. Mr. Theriaque said this next portion of the meeting was not an Appeal. The City Council could grant incentives but they were not required. He asked the Council members for their Jennings Disclosures for the Height Incentives. The Council members gave their Disclosures. Mr. Leonard said the notice requirements for this portion of the meeting had been met. The witnesses were sworn.

Mr. Leonard testified that the Planning Board heard the Height Incentives Request on August 14, 2017, and recommended approval. He said the base height for the south side of Front Beach Road was 150' and with available incentives could reach 220'. For

the north side of Front Beach Road, the base height would be 45' and with available incentives could reach 65'. He said the information was in the Agenda packet which had already been submitted into the record. He continued that Staff originally had a concern about the height incentive increasing the number of units which would increase traffic. The applicant supplied information to Staff and the Planning Board that the additional height would not add any units. He said if the request was granted, that condition might be included in the Order. Mayor Thomas asked the Council members if there were any questions for Mr. Leonard and there were none.

Mr. Alley said they requested height incentives not to increase density but rather to create architectural features for a nicer appearance. Using the map, he identified the areas where they requested the height incentives which would add character and create view corridors. Everything else was below the standard height. Mr. Alley presented a drawing with the maximum number of units allowed, maximum height allowed, which fit the Code but not the intent. Using the Height Incentives, he said this allowed more view. He also stipulated that during the Planning Board meeting, they agreed to improve the beach access to the east even though it was not on their property.

Councilman Solis asked the full density allowed on the property and Mr. Alley responded approximately Nine Hundred (900) units. With their current plan, they were under Six Hundred (600) units. Councilman Solis asked what height they requested since they did not want the full 220'. Mr. Alley said that would be difficult to say exactly as they now had to recalculate with the no exits onto Crane. Right now, they only planned for 189' but may have to go higher to accommodate the extra parking. Mayor Thomas said all those details would be worked out during the Development Order process, such as the traffic, noise, etc. Mr. Alley said they might have to request an additional floor of parking, increasing the height to 200' and explained in detail. He said there were no incentives requested to go higher near Crane Street. There were no further questions from the Council members.

Mr. Fischetti asked what would be done to earn the Height Incentives. Mr. Alley deferred to their architect, Mr. Mauricio Castro, for the detailed explanation of the various items allowed in the LDC. He said they also planned three beach accesses in addition to the Beach Access #32 which was being improved even though not on their property. Mr. Fischetti said they were concerned of what recourse the City would have if the developer in the future did not build the open spaces, outdoor spaces, etc. Mr. Alley responded that Code Enforcement would stop them.

Mr. LeCain said the Planning Board's approval August 14, 2017 did not meet the regulations for the Height Variance. He elaborated on their reasons. He said the Variance was not compatible with Bid-A-Wee beach and did not meet the purposes of the LDC. There were no questions from Mr. Alley.

Mr. Smith said the residents would be happy with 150' because the developer had that right to build to that height but they opposed any Height Incentives. There were no questions from Mr. Alley.

Mayor Thomas asked if anyone in the audience wished to speak.

Mr. Ken Johnson, 135 Sea Oats Drive. Mr. Johnson said things were said differently in this meeting as opposed to the Planning Board meeting. He said he was confused on what the developer planned to build.

Mr. Theriaque asked if the adversely affected parties or Mr. Alley had any rebuttal evidence to be presented. There was none.

Mr. Alley closed by stating they were within the LDC, the development would be for the betterment of the community, and future details of their development would be available further in the process.

The adversely affected parties had no closing statements.

Councilman Solis asked Mr. Gisbert if any Height Incentives had been used on the beach to date. There were none. He questioned Mr. Leonard what could be done if the developer built within the openness stipulated within the height Incentives. Mr. Leonard said the City could remove the structures and lien the property.

Councilwoman Strange asked the height of the Chateau and Mr. Leonard replied 220'. He said that had been the developer's request to the Planning Board and would ultimately come to the Council for approval as the zoning was for 150'.

Councilman Reichard asked Mr. Leonard if the three beach accesses would be public. Mr. Leonard said that would be the public benefit associated with the Height Incentive. Discussion ensued concerning the value of linear footage on the beach and the value in the Height Incentives.

Councilman Chester mentioned the new Holiday Inn Express with the glass windows for the pool area. He questioned if the guests would be able to see traffic. Mr. Alley responded that the pool area visitors would not see traffic.

Councilman Reichard mentioned it likely there would be kiosks, flowers, obstructions and such placed in the open spaces and how easy it would be for items to go in that empty space. He questioned who would police that open view corridor.

Mayor Thomas asked if there would be parking for the beach accesses. Mr. Alley said they would allot ten parking spaces for those accesses. The Mayor asked Mr. Alley why the developer would make that offer. Mr. Alley explained why they saw no harm in having those accesses and parking.

Councilman Solis said if the developer built to maximum, it would bring more traffic. **Councilman Solis made the motion to approve the Height Incentive Request not to exceed 203' nor exceed 588 units. Second was by Councilman Reichard.** The Mayor asked for additional comments. Councilman Reichard said if the height was limited, the developer would be able to shrink the view corridor. Mr. Alley said with the additional height, the building would remain as designed and the width not change. Mr. Theriaque questioned Mr. Alley if he would agree for the width to be one of the conditions for approval and Mr. Alley said yes. With no further questions or comments, **the motion passed by majority roll call vote recorded as follows:**

Councilman Reichard	Aye
Councilman Chester	Aye
Councilwoman Strange	Nay
Councilman Solis	Aye
Mayor Thomas	Nay

The meeting was adjourned at 5:40 P.M.

READ AND APPROVED this 14th of December 2017.

IN THE EVENT OF A CONFLICT BETWEEN THE FOREGOING MINUTES AND A VERBATIM TRANSCRIPT OF THESE MINUTES, THE FOREGOING MINUTES SHALL CONTROL.

Mayor

ATTEST:

City Clerk

The Regular Meeting of the City Council of the City of Panama City Beach, Florida, and when permitted or required by the subject matter, the Panama City Beach Community Redevelopment Agency, held on November 9, 2017.

ROLL

MAYOR MIKE THOMAS

COUNCILORS:

JOHN REICHARD

JOSIE STRANGE

PHIL CHESTER

HECTOR SOLIS

CITY MANAGER:

MARIO GISBERT

CITY CLERK:

JO SMITH

CITY ATTORNEY:

AMY MYERS

Mayor Thomas called the Regular Meeting to order at 6:00 P.M. with all Council members, City Manager, City Clerk and City Attorney present.

Navy Chaplain Bill Kundo gave the invocation and Commander Jim Doescher, Military Order of the Purple Heart, led the Pledge of Allegiance.

The Mayor announced the upcoming Community Events.

The Minutes of the Special Meetings of August 24 and September 14, and the Regular Meeting of October 26, 2017 were **read and approved as written per motion by Councilwoman Strange. Second was by Councilman Chester. The motion passed by unanimous roll call vote recorded as follows:**

Councilwoman Strange	Aye
Councilman Solis	Aye
Councilman Reichard	Aye
Councilman Chester	Aye
Mayor Thomas	Aye

Mayor Thomas asked if there were any additions or deletions to the Agenda. Councilman Reichard asked to remove Consent Agenda Item #10, **Resolution 18-17, CRA Vehicle Purchase**, and delay consideration until December 14, 2017 as he did not have sufficient information to make a decision. There were no objections. **Councilman Chester made the motion to approve the Agenda as amended. Second was by Councilwoman Strange and the motion passed by unanimous roll call vote recorded as follows:**

Councilwoman Strange	Aye
Councilman Solis	Aye
Councilman Reichard	Aye
Councilman Chester	Aye
Mayor Thomas	Aye

PRESENTATIONS

1 VETERANS DAY PROCLAMATION AND PRESENTATION. Mayor Thomas, Army veteran, invited Commander Doescher and Navy Chaplain Kundo to the podium as he read the Veterans Day Proclamation in its entirety. The Mayor presented the Proclamation and thanked them for their service and the audience responded with a standing ovation in appreciation for all Veterans.

2 BOYS & GIRLS CLUB CIVIC ACHIEVEMENT AWARD. Mayor Thomas introduced Ms. Iris Skelton to the podium and presented her with the Civic Achievement Award for exemplary service to the Beach Boys and Girls Club. He then congratulated Iris and presented her with a bag from the Council. Ms. Krystle Manley-Reed from the Club spoke a few words about Iris. The audience responded with applause.

3 IRONMAN FLORIDA CHECK PRESENTATION – BEN RAUSA. Mayor Thomas invited Mr. Rausa, Race Director, and Lt. Jamey Wright to the podium. Mr. Rausa spoke of the Ironman Florida event and their donation of Eight Thousand Dollars to Cops N' Kids. He thanked Lt. Wright for law enforcement's efforts in keeping the race participants and fans safe during the race. Lt. Wright thanked Mr. Rausa for the check. Councilman Chester also complimented Lt. Wright for the Cops N' Kids event held this year at Frank Brown Park and the improvements made to the event. The audience responded with applause.

PUBLIC COMMENTS (Consent and Regular Items only)

The Mayor opened the Public Comments portion of the meeting and reminded that the speakers were limited to three minutes on non-Public Hearing items on the Agenda.

1 Mr. Burnie Thompson, 301 Lullwater Drive. Mr. Thompson made comments about the funds set aside for the new City Hall and wasting taxpayer money. He questioned the Council members giving up their car allowance. He made a Public Records Request for supporting documents for comments made by Councilman Solis that 90% of Gross Sales taxes were from tourists.

2 Mr. George Hughes, 17317 Front Beach Road. Mr. Hughes asked when the Agendas were published as he had not had time to read the lengthy Agenda and why comments were not received on each item as presented.

3 Mr. Tim Sowell, 611 Poinsettia Drive. Mr. Sowell made comments about priorities and spending City funds before placing an assessment on the residents.

Mayor Thomas closed the Public Comments portion of the meeting and said that Three Million Dollars had been set aside for the new City Hall and the portion of the Agenda about the Fire Assessment would be able to explain why those monies could not be used for other things.

CONSENT AGENDA

Ms. Smith read the Amended Consent Agenda items by title.

1 NATIONAL PEARL HARBOR REMEMBRANCE DAY" PROCLAMATION. "A Proclamation designating December 7, 2017 as "National Pearl Harbor Remembrance Day" and directing that the flags be lowered to half-staff on December 7th in honor of those who died as a result of their service at Pearl Harbor."

2 RESOLUTION 18-13, NUISANCE ABATEMENT LIEN, 500 WEST GULF BOULEVARD. "A Resolution of the City of Panama City Beach, Florida, approving an amount of \$3,138.16 to be liened on property located at 500 West Gulf Boulevard for costs incurred by the City to abate nuisances located upon such property; authorizing the appropriate officers of the City to record the lien and notify interested parties of such lien; and approving an immediately effective date."

3 ORDER 01-ZN-18, APPROVAL OF THE BAY PARKWAY ZONING. "The City Council of the City of Panama City Beach, having received testimony and reviewed the exhibits produced during the Quasi-Judicial Hearings held on this matter on July 13, September 28, and October 26, 2017, orders that the subject Zoning request is hereby GRANTED and the captioned Ordinance 1421 shall be ADOPTED."

4 ORDER 01-RZ-18, APPROVAL OF THE HOMBRE GOLF CLUB REZONING. "The City Council of the City of Panama City Beach, having received testimony and reviewed the exhibits produced during the Quasi-Judicial Hearings held on this matter on July 13, September 28, and October 26, 2017, orders that the subject rezoning request is hereby GRANTED and the captioned Ordinance 1423 shall be ADOPTED."

5 ORDER 01-RH-18, APPROVAL OF THE LARGE SITE DEVELOPMENT, PCB ACRES, LLC. "The City Council of the City of Panama City Beach, having heard testimony and reviewed the exhibits produced during the Quasi-Judicial Hearing in this matter held on October 12, 2017, orders that the decision of the Planning Board is AFFIRMED and the Large Site Development Application is APPROVED WITH THE CONDITION as more particularly described in the body of the Order."

6 ORDER 02-CU-18, APPROVAL OF HEIGHT INCENTIVE, PCB ACRES, LLC. "The City Council of the City of Panama City Beach, being fully advised in the premises and having held a Public Hearing on this matter on October 12, 2017, orders that the Applicant's Height Increase Request is hereby APPROVED WITH CONDITIONS as more particularly described in the body of the Order."

7 RESOLUTION 18-14, CODE ENFORCEMENT VEHICLE PURCHASE. "A Resolution of the City of Panama City Beach, Florida, approving the purchase of 2018 Ram 1500 Quad Cab 4x4, DS6L41, from Autonation Chrysler Dodge Jeep Ram Pembroke Pines in the basic amount of \$26,920; and providing an effective date."

8 RESOLUTION 18-15, BID AWARDS- WWTF INFLUENT PIPING REPLACEMENT. "A Resolution of the City of Panama City Beach, Florida, approving the purchase of piping replacement materials for the City's Wastewater Treatment Facility from three different vendors in the total amount of \$316,999.34 as more particularly set forth in the Resolution; and providing an immediately effective date."

9 RESOLUTION 18-16, BID AWARD- SOIL CONDITIONING CHEMICALS PURCHASE. "A Resolution of the City of Panama City Beach, Florida, approving the purchase of soil conditioning chemicals for the City's Parks and Recreation Department from Southeastern Turf for \$80,820.50; and providing an immediately effective date."

10* RESOLUTION 18-17, CRA VEHICLE PURCHASE. Removed.

Councilman Reichard made the motion to approve the Amended Consent Agenda. Second was by Councilwoman Strange and the motion passed by unanimous roll call vote recorded as follows:

Councilwoman Strange	Aye
Councilman Solis	Aye
Councilman Reichard	Aye
Councilman Chester	Aye
Mayor Thomas	Aye

REGULAR AGENDA- DISCUSSION/ACTION

ITEM 1 ORDINANCE 1426, AMENDING LDC REVISING PODIUM STANDARDS IN FBO-1 DISTRICT, 2ND READING, **PUBLIC HEARING** AND ADOPTION. Ms. Myers read Ordinance 1426 by title. The Mayor asked the Council members if they had any questions or comments; there were none. He opened the Public Hearing at 6:34 P.M. and asked for comments from the audience. There were none. He closed the Public Hearing at 6:34 P.M. **Councilman Chester made the motion to approve Ordinance 1426. Second was by Councilwoman Strange and the motion passed by unanimous roll call vote recorded as follows:**

Councilwoman Strange	Aye
Councilman Solis	Aye
Councilman Reichard	Aye
Councilman Chester	Aye
Mayor Thomas	Aye

ITEM 2 ORDINANCE 1437, AMENDING LDC REGARDING SURFACE PARKING STANDARDS IN FBO DISTRICT, 2ND READING, **PUBLIC HEARING** AND ADOPTION. Ms. Myers read Ordinance 1437 by title. The Mayor asked the Council members if they had any questions or comments; there were none. He opened the Public Hearing at 6:35 P.M. and asked for comments from the audience.

1 Mr. Burnie Thompson, 301 Lullwater Drive. Mr. Thompson made comments about the Mayor's fence.

2 Mr. George Hughes, 17317 Front Beach Road. Mr. Hughes asked Ms. Myers to explain the purpose of the proposed Ordinance and if it meant he must build a garage.

3 Ms. Genese Hatcher. Ms. Hatcher asked Ms. Myers to explain the proposed Ordinance in laymen's terms. Ms. Myers did so.

There were no further comments. The Mayor closed the Public Hearing at 6:40 P.M. **Councilman Reichard made the motion to approve Ordinance 1437. Second was by Councilman Solis and the motion passed by unanimous roll call vote recorded as follows:**

Councilwoman Strange	Aye
Councilman Solis	Aye
Councilman Reichard	Aye
Councilman Chester	Aye
Mayor Thomas	Aye

ITEM 3 ORDINANCE 1441, ACCESSORY STRUCTURES, 1ST READING, **PUBLIC HEARING**. Ms. Myers read Ordinance 1441 by title. The Mayor asked the Council members if they had any questions or comments; there were none. He opened the Public Hearing at 6:41 P.M. and asked for comments from the audience. There were

none. He closed the Public Hearing at 6:41 P.M. **Councilman Solis made the motion to approve Ordinance 1441. Second was by Councilman Reichard and the motion passed by unanimous roll call vote recorded as follows:**

Councilwoman Strange	Aye
Councilman Solis	Aye
Councilman Reichard	Aye
Councilman Chester	Aye
Mayor Thomas	Aye

ITEM 4 ORDINANCE 1442, ANNUAL UPDATE OF CAPITAL IMPROVEMENTS SCHEDULE, 1ST READING. Ms. Myers read Ordinance 1442 by title. The Mayor asked the Council members if they had any questions or comments; there were none. **Councilman Chester made the motion to approve Ordinance 1442. Second was by Councilman Reichard and the motion passed by unanimous roll call vote recorded as follows:**

Councilwoman Strange	Aye
Councilman Solis	Aye
Councilman Reichard	Aye
Councilman Chester	Aye
Mayor Thomas	Aye

ITEM 5 APPOINT CHAIR FOR PLANNING BOARD FOR 2017-2018. Councilman Reichard said he had worked with Mr. Ed Benjamin, current Chair, for many years. **Councilman Reichard made the motion to reappoint Mr. Benjamin as Chair.** Councilwoman Strange asked if Mr. Benjamin had said he would serve again and Councilman Reichard said yes. She asked if anyone else had said they would like to serve and Councilman Reichard said no one had mentioned it to him. Councilman Solis said no one had contacted him and Councilwoman Strange said she had not been contacted either. **Second was by Councilman Solis and the motion passed by unanimous roll call vote recorded as follows:**

Councilwoman Strange	Aye
Councilman Solis	Aye
Councilman Reichard	Aye
Councilman Chester	Aye
Mayor Thomas	Aye

ITEM 6 TDC BOARD MEMBERS APPOINTMENTS. Mr. Gisbert said the Council had the opportunity to advertise for the Non-Collector seat on the TDC Board or reappoint the current member, Mr. Gary Walsingham. He added that the Council had the choices to reappoint or select new Council members to sit on the TDC Board. Councilman Solis recommended taking applications for the Non-Collector seat to see if others were interested. Councilwoman Strange concurred. There were no objections.

Councilman Reichard made the motion to reappoint Mayor Thomas and Councilman Chester to the TDC Board. Second was by Councilman Solis and the motion passed by unanimous roll call vote recorded as follows:

Councilwoman Strange	Aye
Councilman Solis	Aye
Councilman Reichard	Aye
Councilman Chester	Aye
Mayor Thomas	Aye

ITEM 7 ORDINANCE 1438, CHARTER AMENDMENT PIGGYBACKING, 2ND READING, PUBLIC HEARING AND ADOPTION. Ms. Myers read Ordinance 1438 by title. The Mayor asked the Council members if they had any questions or comments; there were none. He opened the Public Hearing at 6:45 P.M. and asked for comments from the audience.

1 Ms. Sara Moon, 123 Heritage Circle. Ms. Moon asked for an example of piggybacking. Ms. Myers explained multi-year State contracts and how they could be used if this Ordinance was adopted. She referenced the piggybacked vehicle purchases that used State contracts on the Agenda.

There were no further questions or comments from the audience. The Mayor closed the Public Hearing at 6:48 P.M. **Councilman Reichard made the motion to approve Ordinance 1438. Second was by Councilman Solis and the motion passed by unanimous roll call vote recorded as follows:**

Councilwoman Strange	Aye
Councilman Solis	Aye
Councilman Reichard	Aye
Councilman Chester	Aye
Mayor Thomas	Aye

ITEM 8 ORDINANCE 1439, CHARTER AMENDMENT BEACH ACCESS SWAPPING, 2ND READING, PUBLIC HEARING AND ADOPTION. Ms. Myers read Ordinance 1439 by title. The Mayor asked the Council members if they had any questions or comments; there were none. He opened the Public Hearing at 6:49 P.M. and asked for comments from the audience.

1 Mr. George Hughes, 17317 Front Beach Road. Mr. Hughes asked which beach easement was being swapped.

2 Ms. Debbie Sasser. Ms. Sasser said it had always been the practice for this type matter to come to the residents in a referendum and asked why the change.

There were no further questions or comments from the audience. The Mayor closed the Public Hearing at 6:51 P.M. He explained the residents would still have the referendum vote if there was a loss of easement land. However, this Ordinance set the standards to allow the Council to swap an easement on a property if there was no loss of land and would allow the City to ask for more land as a benefit to the City when making the swap. **Councilman Solis made the motion to approve Ordinance 1439. Second was by Councilman Chester and the motion passed by majority roll call vote recorded as follows:**

Councilwoman Strange	Nay
Councilman Solis	Aye
Councilman Reichard	Aye
Councilman Chester	Aye
Mayor Thomas	Aye

ITEM 9 PLAT APPROVAL LYNDELL PLACE, PUBLIC HEARING (CONTINUED). Ms. Myers asked the Council members for their Jennings Disclosures. Councilman Solis said he knew the location and had only spoken with the City Manager. Councilwoman Strange said she knew the property's location and had spoken with no one. Councilman Reichard said he knew the location and had only spoken with the City Manager. Councilman Chester said he knew the property's location and had spoken with the City Manager and Mr. Leonard. Mayor Thomas said he knew the property's location and had spoken with no one.

Ms. Myers said this was subdividing the land into twelve lots and there was no Horizontal Infrastructure Completion Agreement associated with the parcel. She confirmed that notice had been given for the Public Hearing and the certifications were on the plat. Ms. Jenkins confirmed that the subdivision met the City's requirements and the Public Hearing had been properly noticed. She stated the plat had been reviewed by Staff. She said the developer was dedicating the sidewalk, water and sewer. Staff also obtained a Bond to ensure damages to the road during construction would be repaired. Mr. Leonard confirmed that the plat was in the City, consistent with the Comp Plan, and compatible with the LDC. The Mayor asked the Council members if they had any questions or comments; there were none. The Mayor reopened the Public Hearing at 6:55 P.M. and asked for audience comments or questions. There were none. He closed the Public Hearing at 6:55 P.M. **Councilman Chester made the motion to approve the Plat. Second was by Councilman Reichard and the motion passed by unanimous roll call vote recorded as follows:**

Councilwoman Strange	Aye
Councilman Solis	Aye
Councilman Reichard	Aye
Councilman Chester	Aye
Mayor Thomas	Aye

ITEM 10 RESOLUTION 18-18, UTILITY VEHICLE PURCHASE AND BUDGET AMENDMENT #2. Ms. Myers read Resolution 18-18 by title. The Mayor asked the Council members if there were any questions or comments; there were none. **Councilman Chester made the motion to approve Resolution 18-18. Second was by Councilman Reichard and the motion passed by unanimous roll call vote recorded as follows:**

Councilwoman Strange	Aye
Councilman Solis	Aye
Councilman Reichard	Aye
Councilman Chester	Aye
Mayor Thomas	Aye

ITEM 11 RESOLUTION 18-20, BID AWARDS- 2018 POLICE FLEET VEHICLES PURCHASE AND EQUIPMENT INSTALLATION. Ms. Myers read Resolution 18-20 by title. The Mayor asked the Council members if there were any questions or comments. Councilwoman Strange asked Chief Whitman about the Dodge Chargers being outdated. Chief Whitman replied that the Dodge Chargers were adequate for his administrative personnel and were cheaper. **Councilwoman Strange made the motion to approve Resolution 18-20. Second was by Councilman Chester and the motion passed by unanimous roll call vote recorded as follows:**

Councilwoman Strange	Aye
Councilman Solis	Aye
Councilman Reichard	Aye
Councilman Chester	Aye
Mayor Thomas	Aye

ITEM 12 UPDATED FIRE DEPARTMENT JOB DESCRIPTIONS. Mr. Gisbert explained with the City's relatively young Fire Department, some of the timelines in the old job descriptions, such as having five to ten years experience, would prevent promotions from within the Department. Staff reviewed and recommended reducing

some of those timelines as well as the creation of a new Administrative Officer. The Mayor asked if there were any question from the Council members and there were none. **Councilwoman Strange made the motion to approve the revised and new Fire Department job descriptions. Second was by Councilman Chester and the motion passed by unanimous roll call vote recorded as follows:**

Councilwoman Strange	Aye
Councilman Solis	Aye
Councilman Reichard	Aye
Councilman Chester	Aye
Mayor Thomas	Aye

ITEM 13 RESOLUTION 18-19, COUNCIL DIRECTION ON FIRE SPECIAL ASSESSMENT. Ms. Myers read Resolution 18-19 by title and said blanks were to be filled in if the Council decided to adopt the Resolution. She said with the consensus from the Workshop and recommendations by the City Manager, she read Section B in its entirety with those numbers inserted. Councilwoman Strange asked where the savings of \$3.68 Million Dollars would be used. Mayor Thomas said the City already had the funds through Impact Fees saved for the new Fire Station. However, the General Fund did not have the money to fund the benefits and salaries for the new firefighters year after year. Councilman Reichard said the number for salaries and benefits was over Two Million Dollars annually. Councilwoman Strange questioned why tax the residents when the City was rich. Councilman Reichard said the City had added sixteen new employees for this year which would use those additional funds. Mayor Thomas asked Councilwoman Strange how she would pay for the additional firefighters and she stated to tax the tourists. Mayor Thomas responded that it was against the law to tax the tourists. Councilwoman Strange suggested a resort fee. Mayor Thomas said the City could not pay to maintain the service level without the assessment. Councilwoman Strange suggested placing the question on the ballot for a vote and the Mayor responded that this method was a fairer way to pay for the additional personnel. Ms. Myers added that the value of the land was removed from this equation. Mayor Thomas reported that these totals would be less than the Fire Assessment for properties in the County. Councilman Solis asked Deputy Chief Couch to report some statistics for the public.

Deputy Chief Couch reported that last year, they responded to over 5,000 calls and this year to date was 4,244 calls. He said with the two fire stations, eleven people were on duty 24/7, provided that no one called in sick or took vacation which would prompt shutting down a vehicle or calling in someone off-duty. He said Panama City had five fire stations with 25 people on duty daily handling 5,000 calls per year. South Walton County had five stations with 33 people on duty daily handling 5,000 calls per year. He added that his officers were becoming burnt out due to the volume of calls. Councilwoman Strange said compared to the number of full-time residents of Panama City, Panama City Beach had only 13,000. Councilman Solis said at any given day during the year, the City may total 40,000 with the additional tourists. Councilwoman Strange agreed and said there should be some way to tax the tourists and not the residents. She said she saw this as a future hardship to the longtime residents. Councilman Reichard said in that case, the residents could apply under the hardship provision to seek relief. Councilman Solis spoke of the emotional toll with the current call volume and so few firefighters. He said the question was why the tourists could not pay for the extra firefighters, and he reminded that the 90% of the Gross Sales taxes were already paid by the tourists as reported by the Chamber and EDA. He explained that if someone lived outside of City limits, they would pay 40% more by living in the

unincorporated portion of the island. He said Walton County had an assessment as well as Bay County.

A question from the audience was if there were other ways to fund this service. Councilman Solis said Staff and Council had looked at all avenues. Another question was why not use the Three Million Dollars set aside for the new City Hall. He responded that those funds would not cover reoccurring costs for salaries and benefits for the new firefighters.

Councilman Chester said part of the City had slow response time, the rear portion of Colony Club, sometimes taking 10-18 minutes. He mentioned safety for all citizens but at what cost.

Ms. Myers gave an example of an average single-family home, with the flat \$78.00 per parcel and an additional cost of \$.66 per \$1,000 of relative improvements, with the potential Assessment totaling \$156.44 annually. Councilman Solis spoke of the higher ISO 2 rating, with potential lower insurance rates for the residents. **Councilman Solis made the motion to approve Resolution 18-19. Second was by Councilman Reichard and the motion passed by majority roll call vote recorded as follows:**

Councilwoman Strange	Nay
Councilman Solis	Aye
Councilman Reichard	Aye
Councilman Chester	Nay
Mayor Thomas	Aye

ITEM 14 ORDINANCE 1444, FIRE SERVICE ACCESSMENT ORDINANCE 1ST READING. Ms. Myers read Ordinance 1444 by title and said this was a procedural Ordinance which would establish the Fire Assessment program. Councilwoman Strange asked Ms. Myers to explain the Ordinance in laymen's terms, and a yes vote for the First Reading would move the Ordinance to the Public Hearing and give notice. **Councilman Solis made the motion to approve Ordinance 1444. Second was by Councilman Reichard and the motion passed by unanimous roll call vote recorded as follows:**

Councilwoman Strange	Aye
Councilman Solis	Aye
Councilman Reichard	Aye
Councilman Chester	Aye
Mayor Thomas	Aye

DELEGATIONS AND STAFF

1 Mr. Paul Dalton, 107 Manistee. Mr. Dalton thanked the Council for their support for the Police Department and requested the City hire more officers.

2 Mr. Gary Beck, 2601 Beech Drive and 5500 Pinetree. Mr. Beck made comments about his water situation, intimidation, corruption, and his speaking at the Bay County Commission. He also claimed a federal case pending against the Mayor.

3 Mr. Burnie Thompson, 301 Lullwater Dr. Mr. Thompson thanked Mayor Thomas and Councilman Reichard for their service. He mentioned the suggestion made previously of background and credit checks for potential Council members. He also commented about the water being shut off at Ms. Hatcher's homes.

4 Mr. Tod Ingram, 12202 Hutchison, Sports Vehicles Assn. Mr. Ingram gave the example of Miramar Beach taxing the tourists via a user tax and having no City Council members.

5 Ms. Jessica Diliberto. Ms. Diliberto questioned why the Fire Department would respond when an ambulance was called. She also mentioned a resort fee in Orlando and that the tourists should bear most of the tax burden because they used more resources.

6 Ms. Genese Hatcher. Ms. Hatcher commented about the situation at her rental homes with the water being turned off, preventing a wedding from occurring. She spoke of the number of employees, two Police Officers and the K-9, at her location and the water turned off while the sprinkler company was attempting to install the sprinkler system.

7 A gentleman living at 112 Coral Drive spoke of Spring Break and the Council's plan to pay Police and Fire.

8 Mr. George Hughes, 17317 Front Beach Road. Mr. Hughes said he would start attending meetings after an absence of three years.

The Delegations portion of the meeting was closed at 7:43 P.M.

Mayor Thomas explained why the Fire Department would respond to emergency calls. He said the City had a plan and it was working as shown by the increased revenue and the beach looking better. He stated the City was growing with numerous events and more hotels coming. Councilman Solis said the County only had five ambulances and the City's Firefighters were trained paramedics who could render aid in the event all five ambulances were already in service at other calls. Councilman Reichard said it was the Fire Department's job to stabilize the person until the ambulance could arrive for transport, and many times the fire truck arrived first on scene.

The Mayor responded to Ms. Hatcher's comments about her water being turned off. He asked Mr. Gisbert to report the timelines and deadlines, and none of the deadlines were met. Regarding the Police Officers on site, Chief Whitman stated that he had dispatched one administrative officer to the site and possibly the K-9 officer stopped because it was his territory.

Councilman Reichard stated that Ms. Hatcher had not met the deadlines through the Fall season yet continued to rent the two buildings and that she had been given the dates as well as extensions.

The meeting was adjourned at 7:50 P.M.

READ AND APPROVED this 14th of December, 2017.

IN THE EVENT OF A CONFLICT BETWEEN THE FOREGOING MINUTES AND A VERBATIM TRANSCRIPT OF THESE MINUTES, THE FOREGOING MINUTES SHALL CONTROL.

ATTEST:

Mayor

City Clerk

PRESENTATIONS

1

CITY OF PANAMA CITY BEACH

CIVIC ACHIEVEMENT AWARD

Be It Known That

Isabella Tomlinson

**HAS GIVEN EXCEPTIONAL SERVICE
TO THE BOYS AND GIRLS CLUB
OF PANAMA CITY BEACH**

For the responsibility assumed, for the unselfish
service rendered her community and its citizens in discharging
the duties of good citizenship, this token of CIVIC ACHIEVEMENT
is hereby awarded.

Presented this 14th of December, 2017



MAYOR MIKE THOMAS

CONSENT AGENDA

ITEM 1



CITY OF PANAMA CITY BEACH AGENDA ITEM SUMMARY

1. DEPARTMENT MAKING REQUEST/NAME:

Parks and Recreation

2. MEETING DATE:

December 14, 2017

3. REQUESTED MOTION/ACTION:

For the City of Panama City Beach to proclaim January 6, 2018 as "Arbor Day".

4. AGENDA

PRESENTATION
PUBLIC HEARING
CONSENT
REGULAR

5. IS THIS ITEM BUDGETED (IF APPLICABLE)? Yes No N/A
BUDGET AMENDMENT OR N/A

DETAILED BUDGET AMENDMENT ATTACHED Yes No N/A

6. BACKGROUND: (WHY IS THE ACTION NECESSARY, WHAT GOAL WILL BE ACHIEVED)

The Panama City Beach Parks and Recreation will plant 2,000 Longleaf trees on January 6, 2018. This will represent Arbor Day, and allow us to continue being designated as a "Tree City".

CONSENT

AGENDA ITEM # 1



~Proclamation~

A PROCLAMATION DESIGNATING
JANUARY 6, 2018
AS "ARBOR DAY"
IN PANAMA CITY BEACH

- WHEREAS, in 1872, J. Sterling Morton proposed to the Nebraska Board of Agriculture that a special day be set aside for the planting of trees; and
- WHEREAS, this holiday, now called ARBOR DAY, was first observed with the planting of more than a million trees in Nebraska; and
- WHEREAS, ARBOR DAY is now observed throughout the nation and the world; and
- WHEREAS, the City of Panama City Beach has now been designated as a "Tree City" and numerous volunteers will assemble at the Conservation Park from 10 AM to 12 Noon to plant 2,000 longleaf pines for the annual Longleaf Tree Planting Celebration, in efforts to bring the Conservation Park back to its original state; and
- WHEREAS, our Conservation Park is a shining example of trees being planted to return the area to woodlands as they had been over a hundred years ago, for the community to enjoy.
- NOW, THEREFORE, the City Council of the City of Panama City Beach, does hereby proudly proclaim January 6, 2018 as

"ARBOR DAY"

in the City of Panama City Beach, and urge our residents and visitors to celebrate Arbor Day and to support the efforts to protect our trees and woodlands. I further urge all citizens to plant trees to gladden the heart and promote the well-being of this and future generations.

Mayor Mike Thomas

Councilman John Reichard
Ward 1

Councilman Phil Chester
Ward 2

Vice-Mayor Josie Strange
Ward 3

Councilman Hector Solis
Ward 4



CONSENT
AGENDA ITEM # 1

CONSENT AGENDA

ITEM 2



CITY OF PANAMA CITY BEACH AGENDA ITEM SUMMARY

1. DEPARTMENT MAKING REQUEST/NAME:
LEGAL

2. MEETING DATE:
DECEMBER 14, 2017

3. REQUESTED MOTION/ACTION:
APPROVE FORM OF ORDER FOR LYNDELL PLACE PLAT

4. AGENDA
PRESENTATION
PUBLIC HEARING
CONSENT
REGULAR

5. IS THIS ITEM BUDGETED (IF APPLICABLE)? Yes No N/A
BUDGET AMENDMENT OR N/A

DETAILED BUDGET AMENDMENT ATTACHED Yes No N/A

6. BACKGROUND: (WHY IS THE ACTION NECESSARY, WHAT GOAL WILL BE ACHIEVED)

PLAT APPROVALS ARE TYPE II APPLICATIONS FOR WHICH A QUASI-JUDICIAL HEARING IS REQUIRED BY LAW.

FOR MATTERS REQUIRING A QUASI-JUDICIAL HEARING, THE CITY'S LAND DEVELOPMENT CODE REQUIRES DECISION MAKING BODIES TO ENTER AN ORDER WHICH CONTAINS FINDINGS OF FACT AND CONCLUSIONS OF LAW IN SUPPORT OF ITS DECISION.

ON OCTOBER 26, THE CITY OPENED A QUASI-JUDICIAL HEARING ON THE PLAT OF LYNDELL PLACE, WHICH WAS CONTINUED TO NOVEMBER 9. ON NOVEMBER 9, THE CITY RE-OPENED AND HELD A QUASI-JUDICIAL HEARING ON THE PLAT, ULTIMATELY ACTING TO APPROVE THE SUBDIVISION OF 1.756 ACRE PARCELS OF LAND INTO 12 RESIDENTIAL LOTS. AN ORDER RECITING THE FACTS AND LAW ARISING FROM THAT HEARING IS ATTACHED FOR YOUR REVIEW.

IF THE ORDER APPEARS ACCURATE, IT MAY BE APPROVED BY MOTION. IF ANY PORTION OF THE ORDER APPEARS INACCURATE OR INCOMPLETE, IT SHOULD BE PULLED FROM THE CONSENT AGENDA SO THAT THE ORDER MAY BE DISCUSSED AND AMENDED AS NECESSARY ON THE REGULAR AGENDA.

CONSENT
AGENDA ITEM # 2

**CITY COUNCIL OF THE
CITY OF PANAMA CITY BEACH**

**IN RE: REQUEST FOR PLAT APPROVAL—LYNDELL PLACE
 SUBDIVIDING 1.756 acres in Panama City Beach
 Bay County Parcel Nos: 34071-000-000, 34086-000-000, and
 34085-000-000
 Owned by LYNDELL HOLDINGS, LLC
 PROPERTY LOCATED immediately north of Front Beach
 Road and east of Lyndell Lane/Kukla Drive intersection**

01-PL-18

ORDER

The **CITY COUNCIL OF THE CITY OF PANAMA CITY BEACH**, having received testimony and reviewed the exhibits produced at the Quasi-Judicial Hearing held on this matter on November 9, 2017, hereby makes the following Findings of Fact and Conclusions of Law.

PROCEDURAL HISTORY

1. Upon original application of Lyndell Holdings, LLC. (the "Applicant"), the owner of 1.756 acres of real property located north of Front Beach Road and east of Lyndell Lane and Kukla Drive intersection, to subdivide such land into 12 residential parcels, by final plat dated October 2017, named Lyndell Place (the "Plat").
2. On October 26, 2017, the City Council opened a quasi-judicial hearing on the plat, which was continued to November 9, 2017. At the hearing re-opened and held on November 9, 2017, the City Council received competent substantial evidence consisting of testimony and documentation from City Staff. Public comment was invited but none received.

FINDINGS OF FACT

3. Notice of the hearing was properly given.
4. The subject property is located entirely within the corporate City limits.

Page 1 of 3

CONSENT
AGENDA ITEM # 2

5. The City has capacity to provide water and sewer service within the Subdivision.
6. The engineering plans and specs for the Subdivision's Improvements appear technically sufficient.
7. The City intends and has sufficient resources to accept and maintain the easements shown and dedicated to the City on the Plat.
8. The title certificate of Attorney's Title Fund Services showed that title to the lands included within the Plat is held by Lyndell Holdings, LLC and that there are no unsatisfied mortgages encumbering the lands platted.
9. The face of the plat contains the surveyor's certificate confirming that the plat was prepared in accordance with the requirements of Chapter 177.

CONCLUSIONS OF LAW

10. Pursuant to Section 177.071, Florida Statutes and Sections 10.04.03 and 10.07.02 of the City's Land Development Code, the City Council has jurisdiction to conduct a quasi-judicial hearing on this matter and determine whether to approve, approve with conditions or deny the plat, based exclusively upon whether the plat conforms to the requirements of law and the City's Land Development Code and Comprehensive Plan.
11. The proposed subdivision request complies with all procedural requirements of the City's Land Development Code.
12. The requested subdivision of land is consistent with the City's Comprehensive Plan.
13. Based upon the uncontradicted certification on the face of the plat, the plat was prepared in accordance with the requirements of Chapter 177.

THEREFORE, IT IS ORDERED AND ADJUDGED that the subject

Page 2 of 3

CONSENT
AGENDA ITEM # _____

2

request to subdivide land is hereby **GRANTED** and accordingly, the captioned plat of LYNDELL PLACE is hereby **APPROVED**.

Parties with standing have the right to appeal this decision by certiorari to the Fourteenth Judicial Circuit Court within thirty (30) days of the date of this Order.

If any part of this Order is deemed invalid or unlawful, the invalid or unlawful part shall be severed from this Order and the remaining parts shall continue to have full force and effect.

DONE this ____ day of _____, 2017.

MIKE THOMAS, MAYOR

ATTEST:

JO SMITH, CITY CLERK

CONSENT AGENDA

ITEM 3



CITY OF PANAMA CITY BEACH AGENDA ITEM SUMMARY

1. DEPARTMENT MAKING REQUEST/NAME:

Parks and Recreation

2. MEETING DATE:

December 14, 2017

3. REQUESTED MOTION/ACTION:

Staff's recommendation is to approve the most responsive low bid from Ready 2 Go Restroom Trailers LLC in the amount of \$28,570.00 for the purchase of a Portable Restroom Trailer and Servicing Units.

4. AGENDA

PRESENTATION
PUBLIC HEARING
CONSENT
REGULAR

5. IS THIS ITEM BUDGETED (IF APPLICABLE)? YES NO N/A
BUDGET AMENDMENT OR N/A

DETAILED BUDGET AMENDMENT ATTACHED YES NO N/A

6. BACKGROUND: (WHY IS THE ACTION NECESSARY, WHAT GOAL WILL BE ACHIEVED)

On November 7, 2017, we received 3 bids for the Portable Restroom Trailer and Servicing Unit. See Attachment A.

This purchase has been budgeted in the adopted 2017-2018 Budget.

City Attorney, City Manager and Finance Director have reviewed and approve the recommendation to award Ready 2 Go Restroom Trailers LLC the Portable Restroom Trailer and Servicing Unit bid in the amount of \$28,570.00.

CONSENT
AGENDA ITEM #

2

RESOLUTION 18-22

A RESOLUTION OF THE CITY OF PANAMA CITY BEACH, FLORIDA, APPROVING THE PURCHASE OF A PORTABLE RESTROOM TRAILER AND SERVICING UNIT FROM READY 2 GO RESTROOM TRAILERS, LLC FOR \$28,570; AND PROVIDING AN IMMEDIATELY EFFECTIVE DATE.

BE IT RESOLVED that the appropriate officers of the City are authorized but not required to accept and deliver on behalf of the City that certain Agreement between the City and Ready 2 Go Restroom Trailers LLC, relating to the purchase of a portable restroom trailer and servicing unit in the basic amount of Twenty Eight Thousand Five Hundred Seventy Dollars (\$28,570), in substantially the form attached and presented to the Council today, with such changes, insertions or omissions as may be approved by the City Manager and whose execution shall be conclusive evidence of such approval.

THIS RESOLUTION shall be effective immediately upon passage.

PASSED in regular session this ___ day of _____, 2017.

CITY OF PANAMA CITY BEACH

By: _____
Mike Thomas, Mayor

ATTEST:

Jo Smith, City Clerk

Resolution 18-22

CONSENT
AGENDA ITEM # _____

3

**CITY OF PANAMA CITY BEACH
 BID TABULATION**

Bidder	Address	Information	Price
Ready 2 Go Restroom Trailers LLC	Imperial, PA 15126	Meets all specs	\$28,570.00
VIP to GO	4 Carol Ave West Haverstraw, NY 10993	Does not meet specs No pictures-no servicing unit	\$36,970.00
Hall Septic Tank Service	3634 Hwy 231 Panama City, FL 32404	Meets all specs	\$61,141.00

*ATTACHMENT
A*

3

 CONSENT
 AGENDA ITEM #

PROPOSAL FORM

TO: City of Panama City Beach, Florida

SUBMITTED: Nov. 7, 2017.

Portable Restroom Trailer & Servicing Unit

The Undersigned, as Bidder, hereby declares that they have examined the proposal specifications and informed themselves fully in regard to all conditions pertaining to the equipment to be supplied.

The Bidder proposes and agrees, if this proposal is accepted, to contract with the **City of Panama City Beach** for the lump sum price listed, to furnish all materials and supplies for the Portable Restroom Trailer & Servicing Unit in complete accord with the described and reasonably intended requirements of the Request for Proposals to the satisfaction of the City, with a definite understanding that no additional money will be allowed for any corrections or additions. Payment in full will be made to the Bidder within 30 days of delivery and with being acceptable to the City. The Bidder further proposes and agrees to deliver the Portable Restroom Trailer and Servicing Unit by **May 1, 2018** with liquidated damages thereafter of \$200.00 per day for non-delivery.

Purchase will be made under terms and conditions specified by City in its form of a Purchase Order. If a deposit is required, it must be specified below. Final payment, in readily available funds, will be made upon acceptance by the City of strictly conforming goods after delivery and install. Strict adherence to design and specifications issued by the City or subsequently accepted in writing by the City will be required.

ADDENDUM ACKNOWLEDGMENT: (Only if addendums have been provided). I, the undersigned bidder, hereby acknowledge receipt of the following addenda: Addendum No. ___ Addendum No. ___.

SUMMARY DESCRIPTION AND LUMP SUM PRICE:

Summary description of the Portable Restroom Trailer and Servicing Unit Proposed:

Proposal includes all required specifications, supporting documents, photos, etc. Lump sum price: 28,570.00 (Twenty-Eight Thousand, Five Hundred, Seventy Dollars)

Note: A detailed description of the products must be included with pictures of the front, back and the inside of the Portable Restroom Trailer proposed. Pictures of the Servicing Units also must be attached.

Lump sum price for the Portable Restroom Trailer & Two Servicing Units:

\$ 28,570.00

Specify terms of any deposit or write "none required": "None Required" - PO Accepted

Name of SUPPLIER: Ready 2 GO Restroom Trailers LLC

ADDRESS: _____ CITY: Imperial STATE: PA ZIP: 15126

EMAIL ADDRESS: Ready2GoRestroomTrailers@gmail.com PHONE: 412-498-2632

SIGNATURE -- (Confirming all information above is correct) [Signature]
Print Name: MARK H. ROSEN and Print Title OWNER

REQUEST FOR PROPOSALS

PORTABLE RESTROOM TRAILER & SERVICING UNIT

CITY OF PANAMA CITY BEACH, FLORIDA

October 17, 2017

Updated on October 16, 2017



CONSENT
AGENDA ITEM #

3

**NOTICE OF
REQUEST FOR SEALED PROPOSALS**

Portable Restroom Trailer & Servicing Unit

The City of Panama City Beach hereby solicits **sealed** proposals for a Portable Restroom Trailer and Servicing Unit which must be reasonably equivalent to certain specifications and requirements set forth by the City in connection with this Notice.

Sealed proposals will be received until **2:00PM Central Daylight Time, November 7, 2017**, at the City of Panama City Beach City Hall Annex, 110 S Arnold Road, Panama City Beach, Florida 32413 and will be opened and publicly read immediately thereafter. All Bids shall be submitted in an envelope clearly marked "Sealed Bid- Panama City Beach – Portable Restroom Trailer and Servicing Unit".

Copies of the specifications may be obtained from the Parks & Recreation Office at 16200 PCB Parkway or on the City's Website at www.pcbgov.com. The point of contact for obtaining specifications is Cheryl Joyner, email address cjoyner@pcbgov.com. No specifications will be issued to suppliers later than seventy-two (72) hours prior to the time indicated above for receiving bids.

Proposals must be submitted upon the standard form contained in the Specifications with such attachments as may be authorized there.

The City reserves the right to (1) reject any and all bids and to waive any informality in bids received, and (2) to award the contract to a bidder other than the lowest bidder should it find that the lowest bidder does not offer the reliability, quality of service or product afforded by such other bidder. Where a bid other than the lowest bid is taken, the City Council will state the reasons upon which such award was made. All bidders shall comply with all applicable state and local laws concerning licensing, registration, and regulations of businesses in the state of Florida.

All Bids shall be firm for a period of 60 days after opening.

END.

Portable Restroom Trailer & Servicing Unit

PART 1 - GENERAL SPECIFICATIONS

- A. The Portable Restroom Trailer will include a removable tongue and meet DOT regulations to be driven on the Highway.
- B. The Portable Restroom Trailer will be not exceed **12' 6" in height**.
- C. The Restroom Trailer will have (1) women's stall and (1) men's stall. Each stall will have (1) sit down toilet. The stalls must be labeled Men's or Women's on the outside.
- D. A minimum of (1) sink in each restroom stall with (1) water nozzle is requested. Other combinations are acceptable as long as a minimum of (1) sink is available in each stall. Sinks can be wall mounted or free standing. Cold water only. Sinks/toilets color is white
- E. The Portable Restroom Trailer will hold a minimum of **350 gallons** of waste.
- F. The electric system in the Portable Restroom Trailer will be 110v.
- G. Interior of restrooms will be illuminated by LED lighting which needs to be 110v.
- H. There will be (2) fan systems for the restroom trailer.
- I. The Portable Restroom Trailer shall not have roof vents installed.
- J. The interior walls, floors, dividers, cabinetry and drains will be a material that is sealed tight and water friendly. The restrooms will be washed out daily with a garden hose. Restrooms must be able to drain each time they are washed. When restrooms are washed, they may drain to the outside of the doors or to an area that drains underneath the restroom trailer.
- K. The exposed metal on the exterior of the restroom trailer will have a special corrosion type of treatment to protect the trailer from the elements of the ocean climate. Color of the exterior will be white. Color of the interior is at discretion of bidder with City approval
- L. The interior/exterior of the metal sub frames will be galvanized steel.
- M. To provide a minimum of a 1 year Warranty on the restroom trailer and all equipment. Vandalism and extreme weather conditions would not be covered under the warranty.
- N. Toilet paper roll/paper towel dispensers will be provided and installed by the City.
- O. **Two (2) Servicing Units – Provide (2) self-contained slide/roll in servicing units. Each unit must hold a minimum of 350 gallons of waste. Each unit should slide/roll into the back of pick-up truck or be on a wheel system to be hauled by a tractor or utility cart. It is our intention for each time we service the restroom trailer to unhook one unit and to replace with an empty unit. Servicing Units must have a secure, leak free and user friendly attachment to the restroom trailer.**
- P. **The Servicing Units will be made of aluminum or stainless steel or a combination of each. Units do not need a freshwater system on it.**
- Q. **The Servicing Unit also must have a minimum of 1 year warranty.**
- R. The City is tax exempt and a copy of certificate of exemption is attached as Exhibit A.
- S. After the Portable Restroom Trailer and Servicing Unit is delivered, payment in full will be made within 30 days of receipt of invoice for the approved bid amount. Invoice shall be submitted in digital Adobe Acrobat pdf format to Cheryl Joyner Recreation Administration Supervisor at cjoyner@pcbqov.com.
- T. The Bidder further proposes and agrees to deliver the Portable Restroom Trailer and Servicing Unit by May 1, 2018 with liquidated damages thereafter of \$200.00 per day for non-delivery.

Note: A detailed description of the products must be included with pictures of the front, back and the inside of the Portable Restroom Trailer proposed. Pictures of the Servicing Units also must be attached.

PART 2 – DATES

1. Sealed Proposals Due Tuesday November 7, 2017 at 2:00pm at City Hall.
2. Proposals will be opened at 2:00 pm at that same time and place.
3. City Council Approval December 7, 2017.
4. Purchase awarded December 8, 2017.
5. Delivery of Portable Restroom Trailer & Servicing Unit will be by May 1, 2018.

PART 3 – LIST OF RFP EXHIBITS –

1. EXHIBIT A Certificate of Tax Exemption



READY2GO
RESTROOM TRAILERS LLC
Luxury Restroom Trailer Rental and Sales
1208 Balsam Drive, Imperial PA 15126 412-498-2632

Thank you for your interest in Ready2Go Restroom Trailers, LLC. Please see our attached quotation based on your specifications. It is understood that there are no specific certifications, stamps or seals required for the production of restroom and shower trailers as they are licensed vehicles and not designed for permanent placement. In the rare circumstances where certification is required for a unique installation, that certification will be provided at additional cost to the quote below.

To place your order, simply sign this quotation and return by email or mail along with your deposit. This will confirm these specifications. Upon receipt of your signed quote and deposit, we will process your order immediately. Production times vary depending upon current orders in production. This time can also vary depending upon circumstances beyond our control.

Please contact us if you wish to modify these specifications or have any questions. Any specification changes after your order is placed will need to be mutually agreed in writing. We look forward to the opportunity to earn you business.

Thank You,
Mark Rosen

SAMPLE PHOTOS OF TRAILERS

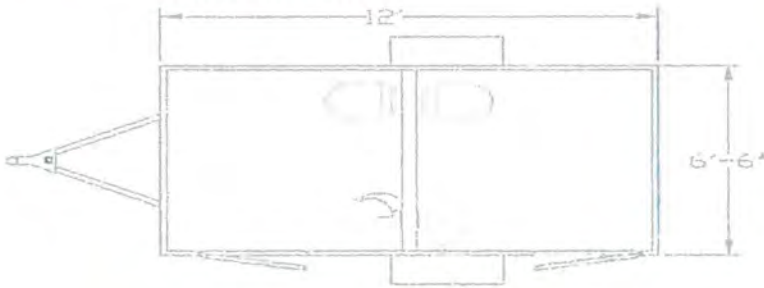

Standard Layout



Standard White Exterior

CONSENT
AGENDA ITEM #

3



1208 Balsam Drive
 Imperial, PA 15126
ready2goestroomtrailers@gmail.com
 Phone: 412-498-2632
 Mark Rosen

Quotation
 11/05/17
 Quote is good for 30 days
 Unless stated otherwise

Customer (Buyer) Name: City of Panama City Beach Address: 110 S Highway 79 City: Panama City Phone: 850-233-5045 Cell: 850-819-3035 Jim Other:		State: FL Fax: Email: cgovner@pcbgov.com Zip: 32413-2140	Ship To: SAME Name: Address: City: Contact: Cheryl Jomer Phone: 850-233-5045 State:
---	--	---	--

Qty	Description	\$ (ea)	Total
1	12' - 2 Station Restroom Trailer with 450 Gallon waste tank Interior - Basic Interior (White FRP) Exterior Color Selection - White	\$19,965	\$ 19,965



Standard Layout

2	350 Gallon Carbon Steel IBC Tank w/ Freight included	\$1,953	\$ 3,905
1	15 foot of hose for waste tank connection	\$138	\$ 138

See the next page for Standard and Optional Items

Installation of optional dispensers is the responsibility of the customer unless otherwise arranged

1	Options listed on next page	\$2,756	\$ 2,756
951	Delivery Charge Per Mile	\$1.90	\$ 1,807
		Sub Total:	\$ 28,570
		Final Price	\$ 28,570

Multi-Trailer Trade Show Wholesale

Estimated Delivery Date (8-12 weeks from order):

*Delivery Date is only an estimate made at the time of quote, and is not guaranteed.

50% Due upon order	\$ 14,285
50% Due Upon Completion	\$ 14,285

Notes:

Agreements:
 *Standard Terms are 50% payment to start an order, remaining due before delivery. **PO's are acceptable from most government agencies and large corporations**
 *Buyer Must Agree to Ready2Go Restroom Trailers' Terms and Conditions sheet. Please let us know if a copy wasn't included with this quote
 *Any Payment by the Customer indicates the Customer agrees to our Terms and Conditions whether its signed or not.
 *Terms are the sole property of Ready2Go Restroom Trailers, LLC Inc until full payment is made and must be turned over if payment isn't made within 30 days of delivery
 I the undersigned would like to purchase the items above in agreement with Ready2Go Restroom Trailers' Terms and Conditions (Terms and Condition page must also be signed)

Signature _____
 Print Name _____

Date _____

CONSENT
 AGENDA ITEM #

3

Standard Items

- A/C (13,500 BTU) and Heat Strip(5,600 BTU)
- Heavy Duty Fold-up Alum. Steps & Rails
- Timed Chrome Faucet
- Oversized Structural Beams
- Steel Construction (No Wood Framing)
- HD Tube Framed Doors & Hydraulic Closures
- Poly Insulation
- Smooth Aluminum Exterior Siding
- LPG On Demand Water Heater
- High Privacy Toilet Partitions that are Half the Distance from the Ground along with no Door Gaps
- One Piece Aluminum Seamless Roof
- FRP (fiberglass wall panels)
- Scissor Jack Levelers
- Dexter (ITS) Independent Torsion Suspension Axles
- Battery Powered Trailer Runaway Protection
- Keyed alike Locks
- Premium LED Trailer Lighting
- Commercial PEX Water Lines
- Powered Vents above Showers
- E-Z Lube Hubs
- Water Repellant Interior Sheeting
- Electric Brakes
- 2- 5/16" Trailer Receiver
- Chip Resistant Undercoating
- Marine Grade Sub Floor
- .04 Painted Aluminum Skin
- Vinyl Sheet Flooring
- Powered Vent Covers
- Waste Tank Sight Gauge

Optional Items (some items may increase lead time)

Color: White Black Powder Gray Green Champagne Beige Victory Red Other:

Qty	Option	\$/ea	Total \$	Qty	Option	\$/ea	Total \$
	Interior upgrade to laminated two tone walls from FRP panels (per trailer foot)	\$77	\$0				
	Interior upgrade to laminate walls with wainscoting from FRP panels (per trailer foot)	\$121	\$0				
	Upgrade to 6 panel oak doors from high privacy metal partition doors (per door)	\$330	\$0				
	Custom Vinyl wrap of exterior of trailer (Customer to supply graphics for wrapping) (per trailer foot)	\$22	\$0				
12	Wash down package (aluminum interior trim caulked along bottom so walls can be scrubbed) per trailer foot	\$33	\$396				
	Generator mount on tongue of trailer with diamond plate encasement (Generator not included)	\$1,100	\$0				
	Tongue prepped for mounting of a generator	\$275	\$0				
	Elite Awning (8' Deep) 12' Length	\$1,155	\$0				
	Elite Awning (8' Deep) each additional foot beyond 12'	\$33	\$0				
	Remote Monitoring Application (Deep Cycle Battery Required)	\$935	\$0				
	RV Propane Heater						
	Solar Panel Charging (per panel)	\$770	\$0				
	Deep Cycle Battery (per battery)	\$275	\$0				
12	12 volt Package with LED Interior Lighting and Pumps (per trailer foot)	\$55	\$660				
	Aluminum diamond plate fold up ramp (to be utilized with the drop box units)	\$3,630	\$0				
	Lowering Trailer with fold up Ramp on Rear (Removal of Tires and Bulldog Jacks)	\$4,180	\$0				
	Aluminum sectional ramp with 5' platform & railing (for wheel Chair access) Quick Easy Setup	\$6,160	\$0				
	Lowering trailer with fold up ramp on rear (Wheelchair access) One Button Execution	\$8,580	\$0				
Qty	Option	\$/ea	Total \$	Qty	Option	\$/ea	Total \$
	Coin Rubber Floor (per trailer foot)	\$77	\$0		Upgrade to Std Residential Toilet	\$418	\$0
	Upgrade to Non Stock Aluminum/Laminate	\$275	\$0		Upgrade to ADA toilet	\$550	\$0
	6 Lug Aluminum Wheels (each)	\$121	\$0		Upgrade to Black Toilet	\$220	\$0
	Increase Trailer by 1ft	\$825	\$0		Upgrade to Black Sink	\$55	\$0
	Non-Powered Vent/Skylight (each)	\$132	\$0		Upgrade to Black Urinal	\$138	\$0
2	Powered Vent/Skylight (each)	\$187	\$0		Add Toilet	\$495	\$0
2	Vent Cover, keeps rain out (each)	\$66	\$0		Add Urinal	\$495	\$0
	Hands Free Sloan Faucet Chrome	\$440	\$0		Single sink to Single Cabinet	\$385	\$0
	Exterior Light (each)	\$204	\$0		Single Sink to Double Sink Solid	\$1,073	\$0
2	Exterior Light (each) LED	\$231	\$462		Double Roll Toilet Paper Dispenser	\$24	\$0
1	Transformer for LED Lights	\$138	\$138		Double Roll Toilet Paper Dispenser/Shelf	\$86	\$0
	Diamond Plate rock guard	\$385	\$0		Stainless Steel C-Fold Paper Towel Dispenser	\$66	\$0
	Spare tire mounted	\$385	\$0		Enmotion Hands Free Paper Towel Dispenser	\$99	\$0
	Skirt (per foot of skirt)	\$28	\$0		Enmotion Hands Free Paper Towel Dispenser (SS)	\$330	\$0
	Utility Room w/ door	\$605	\$0		Foaming or Liquid Soap Dispensers	\$44	\$0
	Vacant/occupied LED Indicators	\$138	\$0		Hands Free GoJo Soap Dispensers	\$88	\$0
	Custom stain color (per trailer foot)	\$39	\$0		Hands Free GoJo Soap Dispensers (SS)	\$132	\$0
	Water tank/pump, 135 gallons	\$858	\$0		Automatic Fragrance Dispensers	\$88	\$0
	Water tank/pump, 225 gallons	\$979	\$0		Stainless Steel Garbage Can (each)	\$99	\$0
	Water tank/pump, 300 gallons	\$1,375	\$0		Sanitary Napkin Disposal SS (each)	\$55	\$0
	Water tank & pump, 400 gallons	\$1,485	\$0		Stainless Steel Shelf (each)	\$86	\$0
	Hot Water Heater (cabinet/utility)	\$303	\$0		Baby Changing Station	\$303	\$0
	Wall heaters (each)	\$231	\$0		Music Amplifier USB and SD Card Player	\$330	\$0
	Winter Package (per trailer foot)	\$55	\$0		Speakers each (typically one per room)	\$132	\$0
	Arctic Package (per trailer foot)	\$110	\$0		Hand Dryer "Air force"	\$451	\$0
	RV Propane Heater	\$1,320	\$0		Outlets-GFI protected	\$132	\$0
	220v/50hz power A/C Heat	\$880	\$0		Kick Plates(Int. of Exterior Door)	\$55	\$0
	Dual 20# Propane Tank Mounted on Tongue	\$385	\$0		Fold Down Seats	\$226	\$0
	Dual 30# Propane Tank Mounted on Tongue	\$495	\$0		Extra Sink (where available)	\$523	\$0
	Dual 40# Propane Tank Mounted on Tongue	\$550	\$0		Replace LPG Tank less with Natural Gas	\$110	\$0
	Dual 100# Propane Tank Mounted on Tongue	\$660	\$0		Replaca LPG Tank less with Electric	\$264	\$0
12	Upgrade to fiberglass subfloor (per trailer ft)	\$55	\$660				
1	Detachable Hitch	\$440	\$440				
Options Selected are Highlighted							\$2,756

I approve the options listed above.

Signature _____

Date _____

CONSENT
AGENDA ITEM #

3

TERMS AND CONDITIONS

- 1. SCOPE OF THESE TERMS AND CONDITIONS OF SALE AND RETURN. The following terms and conditions shall apply to all purchase orders and orders of acknowledgment relating to the sale of Seller's goods. Seller shall not be deemed to have waived any of the following terms or conditions in an order or Seller fails to object to any custom or transaction form being appearing on, attached to or incorporated by reference in any purchase order or order document issued by Buyer. Buyer's ordering, acceptance or use of any goods of Seller shall constitute an acceptance of the following terms and conditions as stated herein.
- 2. QUOTED TERMS. All quoted terms are subject to correction in any case for clerical error and may be modified or withdrawn by Seller with or without notice, in any case prior to written acceptance by Buyer. All quotations shall be deemed withdrawn if not accepted in writing by Buyer within 30 days. Quoted prices are based upon information provided by Buyer including Buyer's estimated annual use, and may be retroactively and prospectively adjusted to the extent of any change in any such information. Quoted prices may also be increased in any case to reflect increases in Seller's production and material costs. All quotations and orders are subject to the written approval of a Director of Seller.
- 3. PRICES. Unless otherwise agreed upon in writing by Seller, all prices, payments and amounts in therein shall be in U.S. dollars. All prices are subject to adjustment to reflect material increases in the price of precious metals included within the goods. Seller reserves the right to increase prices in effect on the delivery date. Prices do not include sales taxes, use or excise taxes, import or export duties or duties, franchise fees, value added taxes, special permits or licenses, or similar charges. Buyer shall either pay such charges or provide Seller with acceptable exemption certificates. Additionally unless otherwise agreed upon in writing by Seller, prices do not include any charges for services such as insurance, handling fees or product orientation or training.
- 4. PAYMENT. Unless otherwise agreed upon in writing by Seller, Seller shall have the right to issue invoices to Buyer upon readiness of goods for delivery by Seller, and all invoices shall be due and payable NET 30 DAYS from date of invoice without regard to delays of transportation, inspection or acceptance. Should Seller deem Buyer's financial position or payment practices to be unsatisfactory, cash payment or other security may be required. If Buyer fails to meet such requirements, Seller may discontinue the production and delivery of goods to Buyer and open such facility at any time thereafter at reasonable grounds for the full and immediate payment of any pending order. Interest shall accrue on any overdue payments at the rate of 1% per month or at the maximum rate for rate of interest in Seller's area.
- 5. TITLE AND RISK OF LOSS. All goods supplied by Seller shall have marketable title, free and clear of all security interests, liens or encumbrances of any third party. Title to the goods and risk of loss shall pass to the Buyer upon arrival of the goods for delivery. Freight and shipping obligations shall terminate on transfer of title on risk of loss. Claims for damages or shortages attributable to Seller must be filed with Seller within 30 days following receipt of goods or notice of loss, a such claims must be accompanied by Seller's packing slip and a detailed description of the claim.
- 6. MODIFICATION OR SUSPENSION OF ORDERS. Requests by Buyer for last modification or change of order, including but not limited to, any change in specifications, quantities or delivery obligations, shall be subject to Seller's written acceptance and may result in adjustments to prices and delivery schedules. Any request by Buyer to suspend any order or delay any delivery shall be in writing and shall be subject to the written consent of Seller. Such suspension or delay may result in adjustments to prices, payments and delivery schedules. The time required for the subsequent completion of any order may exceed the period of suspension or delay due to Seller's scheduling constraints or other reasons. If a requested suspension is more than 30 days in duration, Buyer shall pay Seller pro rata for the portion of the order completed during the period that production has proceeded in the past where Seller deems that it cannot reasonably be made complete or the requirement for suspension is more than 30 days prior to scheduled delivery, the order shall be completed, canceled and placed in storage at Buyer's expense. Title to the goods shall therefore transfer to Buyer. In the event Seller is otherwise unable to deliver the goods when ready due to any other cause or situation of Buyer, Seller shall so notify Buyer. Such inability to deliver shall be subject to the foregoing provisions.
- 7. CANCELLATION OF ORDERS. Any cancellation of an order shall be in writing. Buyer shall pay Seller 5% of the order to cover Seller costs, more for custom orders.
- 8. LIMITED WARRANTY. Except as otherwise specifically set forth herein, Seller warrants only that goods furnished by Seller shall conform to the specifications set forth in the purchase order (including any amendments issued by Seller). Unless otherwise agreed upon in writing by Seller, this limited warranty shall be in effect during a period of 90 days following the date of shipment of the goods. Such limited warranties are covered by manufacturers' warranties and are not the responsibility of the Seller. To obtain consideration under this limited warranty, Buyer must first send a written notice to Seller's facility notifying that the goods are defective. Failure to give such notice within the warranty period shall be a waiver of this limited warranty and no warranties or other action thereafter taken by Seller shall be deemed to extend or revive the warranty period. Any goods believed by Buyer to be defective shall be returned by Buyer to Seller's facility transportation prepaid for replacement by Seller. No goods shall be returned to Seller unless Buyer first obtains a return authorization from Seller. If in Seller's sole judgment the goods returned by Buyer are defective and covered under this limited warranty, Seller shall have the option of repairing or replacing such goods at Seller's charge, provided that such goods are returned to Seller's facility transportation prepaid. This limited warranty shall not apply to goods which in Seller's sole judgment have been the subject of negligence, misuse, abuse, accident, misapplication, tampering or alteration, nor shall it apply to goods damaged by acts of God, war or civil disorders, fire, equipment electricity, conditions, operation, maintenance or storage, or other than normal application, use or wear, including without limitation, failure caused by foreign materials, misuse or wear and tear. This limited warranty shall not cover and Seller shall not make any arrangements to reimburse Buyer for damages for repairs, a person or property, loss of production, loss of profits, loss of use, expenses of labor saved or other items relating to the removal, replacement or recall of defective goods, damages resulting from the removal of defective goods or the installation of repaired or replacement goods, expenses relating to the transportation of goods in and from Seller's facility, damages resulting from any consequential, incidental, contingent or special damages, whether arising in contract or tort or under warranty, or any other damages or expenses not agreed upon in writing by Seller, even if Seller has been advised of the potential for any such damages or expenses. In no event shall Seller's total liability exceed the specific purchase price of the subject goods. THIS LIMITED WARRANTY IS IN LIEU OF ALL WARRANTIES, EXPRESS OR IMPLIED, INCLUDING, WITHOUT LIMITATION, ALL WARRANTIES OF MERCHANTABILITY AND FITNESS FOR A PARTICULAR PURPOSE OR USE. No person is authorized to give any other warranty or to assume any other liability on Seller's behalf.
- 9. PATENT INFRINGEMENT. If a claim is asserted against a infringement of a United States patent relating to any part of the goods (which claim is not based on specifications provided by Buyer), Seller, at its expense, shall either replace or modify such part with a non-infringing part or provide for Buyer the right to use such part, provided that Seller is given a full opportunity to conduct all negotiations in regard to such claims, but in no event shall Seller have any liability for losses arising from any use or misuse of any infringing part. The foregoing provisions shall not be Seller's sole responsibility, and Buyer's sole remedy, with respect to any infringement by any part of the goods supplied to Buyer and SELLER EXPRESSLY DISCLAIMS ANY OTHER WARRANTY AGAINST INFRINGEMENT, WHETHER EXPRESS OR IMPLIED. Buyer shall defend and hold Seller harmless from and against any claims of infringement for any part of the goods designed or manufactured to Buyer or a specification, including the use thereof in combination with other components, materials or processes.
- 10. FORCE MAJEURE. In no event shall Seller be liable for any non-performance, delay in performance, or any other variation from Seller's performance obligations, nor for any loss or damage in any goods supplied to Buyer when occasioned directly or indirectly by any cause beyond the reasonable control of Seller or its suppliers, vendors, subcontractors, or other representatives or agents, including, but not limited to, common law fire, labor, war or failure, natural disasters or acts of God, acts of terrorism or a public enemy, war, riot, national or international economic conditions, epidemics or restrictions of any domestic or foreign governmental agency, acts of God or war or complete or partial interruption of logistic routes or labor deficiencies or failures, shortages or delays in Seller's manufacturing of labor or materials. Seller shall automatically be entitled to a reasonable extension of all periods of performance when delayed by any such cause.
- 11. MISFEITINGS. If Buyer is permitted by Seller to inspect Seller's facilities or processes, Buyer shall not photograph or make or other visual or audio recording therein.
- 12. ASSIGNMENT. Unless otherwise agreed upon in writing by Seller, Seller shall have the right to assign or subcontract the performance of any of its obligations under any order. Any assigned obligation by Buyer of any of its rights or obligations under any order shall be null and void in the absence of Seller's prior written consent.
- 13. INDEPENDENT CONTRACTOR. At all times, Seller shall be deemed an independent contractor of Buyer and not a partner, joint venture, employee or agent of Buyer.
- 14. REGULATORY COMPLIANCE. Buyer shall comply with all applicable laws, regulations and rules governing goods furnished by Seller, including, but not limited to, safety and health standards, environmental regulations, orders of standards and export controls.
- 15. DISPUTES. Buyer and Seller shall use their best efforts to resolve in an amicable manner any dispute arising in connection with any order. In the event that Buyer believes that Seller is not in full compliance with its obligations hereunder, Buyer shall notify Seller in writing and Seller shall take reasonable measures to remedy the alleged non-compliance within 30 days following its receipt of such notice. Any dispute which is not so resolved or resolved shall within a reasonable period of time thereafter be submitted to arbitration in accordance with the Rules of the American Arbitration Association, and judgment upon the arbitrator's award may be entered in any court of competent jurisdiction. Allocation of the costs of arbitration shall be determined by the arbitrator, and each party shall bear its own attorney fees. Unless otherwise agreed hereunder the parties, arbitrator's award shall be final and binding. P.A. U.S.A.
- 16. INTERPRETATION. These terms and conditions shall be governed by and construed in accordance with the law of the State of Pennsylvania, including such State's Uniform Commercial Code, without giving effect to principles of conflict of law. Wherever any conflict may exist between these terms and conditions and any provision of such Uniform Commercial Code, these terms and conditions shall govern. The version hereby granted herein have been intended for convenience only, and shall not be considered as interpreting any term or condition herein. If any term or condition contained herein is found to be invalid or unenforceable, it shall be deemed void, and the remaining terms and conditions herein shall survive and remain in full force and effect. No provision of any law or regulation shall be deemed to have been applied to these terms and conditions hereunder.
- 17. NOTICE. All notices and other communications required hereunder shall be in writing and delivered by a mail, electronic, telegraph, overnight carrier, or certified or registered mail, postage prepaid, return receipt requested. Any such notice shall be deemed to have been given on the date it is received during regular office hours at the address listed on the applicable order or at such other address as the affected party may be previously designated for notices.
- 18. REVISION 18/03.
- 19. SUBSTITUTION. Seller reserves the right to change substitute items with equal or better items.
- 20. INDEMNITY. Buyer agrees to indemnify Seller for all claims or damages arising from the Buyer's possession during the rental period.
- 21. THESE TERMS AND CONDITIONS APPLY TO ALL TYPES OF BUSINESS TRANSACTIONS INCLUDING BUT NOT LIMITED TO SALES, RENTAL, AND ALLIANCE OF ONE PRODUCT. BUYER MAY NOT LEASE, REPRESENT THE PAYING CUSTOMER FOR ANY TYPE OF BUSINESS TRANSACTION AND THE SELLER OR BUYER REPRESENTS THAT THE BUYER IS NOT A LEASER OR REPRESENTATIVE.

I have read and understood and agree fully to these terms and conditions.

Company Name (if one applicable) _____

Title Name _____

Signature _____ Title _____

CONSENT
AGENDA ITEM #

3



Portable Restroom Trailer
&
Servicing Unit
SUPPORTING DOCUMENTS

CONSENT
AGENDA ITEM #

3

PART 1 - GENERAL SPECIFICATIONS



ITEM #	GENERAL SPECIFICATIONS	STATUS - MEET/EXCEED	NOTES
A	The Portable Restroom Trailer will include a removable tongue and meet DOT regulations to be driven on the Highway	MEET	
B	The Portable Restroom Trailer will be not exceed 12' 6" in height.	MEET	
C	The Restroom Trailer will have (1) women's stall and (1) men's stall. Each stall will have (1) sit down toilet. The stalls must be labeled Men's or Women's on the outside.	MEET	
D	A minimum of (1) sink in each restroom stall with (1) water nozzle is requested. Other combinations are acceptable as long as a minimum of (1) sink is available in each stall. Sinks can be wall mounted or free standing. Cold water only. Sinks/toilets color is white	MEET	
E	The Portable Restroom Trailer will hold a minimum of 350 gallons of waste	MEET and EXCEED	Trailer comes with 450 Gallon waste Tank
F	The electric system in the Portable Restroom Trailer will be 110v	MEET	
G	Interior of restrooms will be illuminated by LED lighting which needs to be 110v.	MEET	
H	There will be (2) fan systems for the restroom trailer.	MEET	
I	The Portable Restroom Trailer shall not have roof vents installed.	MEET	
J	The interior walls, floors, dividers, cabinetry and drains will be a material that is sealed tight and water friendly. The restrooms will be washed out daily with a garden hose. Restrooms must be able to drain each time they are washed. When restrooms are washed, they may drain to the outside of the doors or to an area that drains underneath the restroom trailer.	MEET	FRP (fiberglass wall panels), Upgraded Fiberglass Subfloor, Washdown Package to include Aluminum trimmed caulked along bottom, to provide additional seal from water. Coin Rubber Sub-Floor for increased handling of wear and tear, and water.

CONSENT
AGENDA ITEM #

3



PART 1 - GENERAL SPECIFICATIONS

ITEM #	GENERAL SPECIFICATIONS	STATUS - MEET/EXCEED	NOTES
K	The exposed metal on the exterior of the restroom trailer will have a special corrosion type of treatment to protect the trailer from the elements of the ocean climate. Color of the exterior will be white. Color of the interior is at discretion of bidder with City approval	MEET	
L	The interior/exterior of the metal sub frames will be galvanized steel.	MEET and EXCEED	Based on Steel Frame w/ protective coating - The warranty on Frame is 5 Years vs. the 1 year required
M	To provide a minimum of a 1 year Warranty on the restroom trailer and all equipment. Vandalsm and extreme weather conditions would not be covered under the warranty.	MEET and EXCEED	Ready2Go Restroom Trailers, LLC (warrantor), of Imperial, Pennsylvania hereby provides a 5-year limited warranty on our trailer frame and axles and a 2-year limited warrantee on the trailer as a whole. Sealant, electrical components, hydraulics, hoses, wall coverings, trim and paint are warranted for 1-year. The warrantor guarantees the product against defects in materials and workmanship.
N	Toilet paper roll/paper towel dispensers will be provided and installed by the City.	MEET	
O	Two (2) Servicing Units – Provide (2) self-contained slide/roll in servicing units. Each unit must hold a minimum of 350 gallons of waste. Each unit should slide/roll into the back of pick-up truck or be on a wheel system to be hauled by a tractor or utility cart. It is our intention for each time we service the restroom trailer to unhook one unit and to replace with an empty unit. Servicing Units must have a secure, leak free and user friendly attachment to the restroom trailer.	MEET	Restroom trailer includes an on-board/self-contained 450 gallon waste holding tank, in addition the proposal includes two(2) additional 350 gallon holding tanks for servicing. These tanks will be Forklifted off Pler to truck or trailer for disposal. In addition a 15 foot hose with Cam-locks is also included for transfer of waste from trailer to holding tanks.
P	The Servicing Units will be made of aluminum or stainless steel or a combination of each. Units do not need a freshwater system on it.	MEET	

AGENDA ITEM #

CONSENT

W



PART 1 - GENERAL SPECIFICATIONS

ITEM #	GENERAL SPECIFICATIONS	STATUS - MEET/EXCEED	NOTES
P	The Servicing Units will be made of aluminum or stainless steel or a combination of each. Units do not need a freshwater system on it.	MEET	
Q	The Servicing Unit also must have a minimum of 1 year warranty.	MEET	
R	The City is tax exempt and a copy of certificate of exemption is attached as Exhibit A.	MEET	
S	After the Portable Restroom Trailer and Servicing Unit is delivered, payment in full will be made within 30 days of receipt of invoice for the approved bid amount. Invoice shall be submitted in digital Adobe Acrobat pdf format to Cheryl Joyner Recreation Administration Supervisor at cjoyner@pcb.gov.com.	MEET	
T	The Bidder further proposes and agrees to deliver the Portable Restroom Trailer and Servicing Unit by May 1, 2018 with liquidated damages thereafter of \$200.00 per day for non-delivery.	MEET	Normal production is 10-12 weeks from Purchase Order Date or deposit received
NOTE:	A detailed description of the products must be included with pictures of the front, back and the inside of the Portable Restroom Trailer proposed. Pictures of the Servicing Units also must be attached	MEET	

CONSENT
AGENDA ITEM #

3

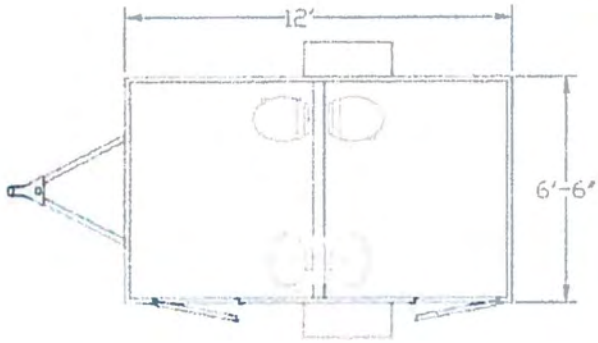

Standard Layout



CONSENT
AGENDA ITEM #

2



350 Gallon Carbon Steel IBC Tank

Most advanced liquid handling tank in the market today!

The 26BC53 is a 350 gallon carbon steel IBC tank. These carbon steel intermediate bulk containers are the most advanced liquid handling tank in the market today. With a patented one-piece top and superior draining bottom, these IBC containers set the industry standard for performance. Each tank meets or exceeds all Intermediate Bulk Container requirements, per Title CFR49 of the Hazardous Material Guide. Design approvals include a UN rating of UN31A.

**All carbon steel tanks come in standard blue.

**Additional sizes and options available, please call for details.

CONSENT
AGENDA ITEM # _____

3



An intermediate bulk container, or IBC, is a type of reusable container made for the storage and transport of bulk liquids. These containers are highly utilized in the food, chemical, petroleum and pharmaceutical industries, and come in a wide variety of sizes and shapes to accommodate different industry needs. IBCs typically have a stacking design and can be moved with a pallet jack or forklift.

Key benefits

- Heavy duty 10 gauge construction
- Standard blue enamel exterior
- 22-1/2" diameter top fill opening with drum cover with 3" threaded fusible vent/fill cap installed in center of cover for UN31A compliance
- EPDM lid gasket and plated steel bolted clamp ring
- 2" patented TranSeal bung plug and EPDM gasket in the top for venting or filling
- 1/2" patented sloped bottom for drainage
- 2" bottom outlet with 2" 316 stainless steel ball valve, shipping plug and patented stamped guard
- Four (4) combination leg positioners/lifting lugs on the top of the tank
- Four (4) legs providing 5-1/2" clearance
- UN31A designed, tested and labeled

Downloads:

[Specification Sheet](#)

Material:

Carbon steel (CS) is metal alloy that is made of iron and carbon. It is known as a cost-effective alloying material. There are four types of carbon steel that vary in strength level: low carbon steel, medium carbon steel, high carbon steel, and very high carbon steel. Engine parts, car body panels, and select knives are made of carbon steel. The Cary Company also has carbon steel IBC tanks, filter vessels, and drums that work well with many liquids.

Disclaimer: This information has been provided as a general guide. It is the customer's responsibility to select the proper container for product and application compatibility.

Additional Information

Capacity	350 gal.
Condition	New
Color	Blue
Material	Carbon Steel
Dimensions	42"W x 48"D x 47"H
Weight	460 lbs.
UN Rating Liquid	UN31A

Note:

**All carbon steel tanks come in standard blue.
**Additional sizes and options available, please call for details.

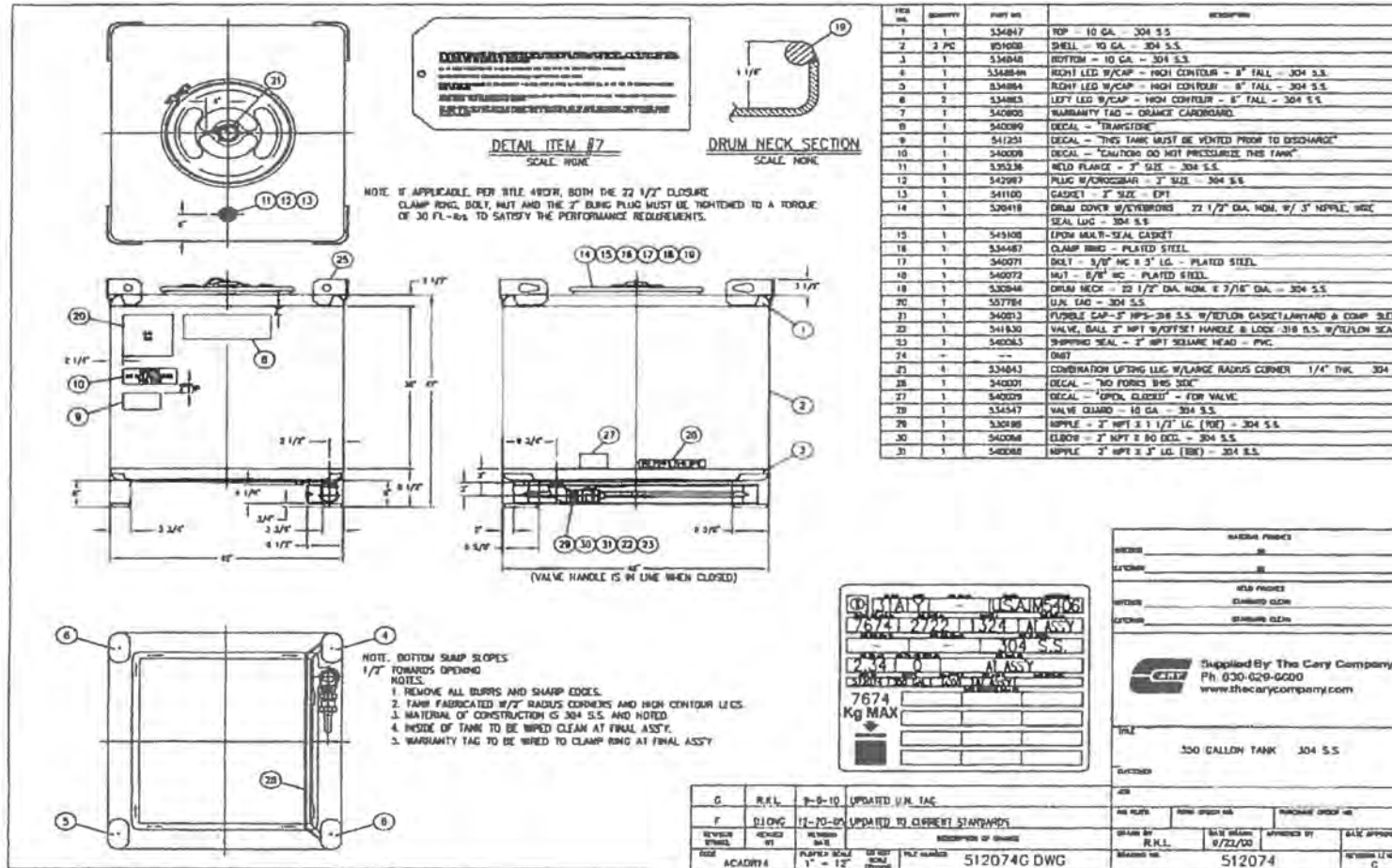

CONSULT
AGENDA ITEM #

3



Warranty

Ready2Go Restroom Trailers, LLC (warrantor), of Imperial, Pennsylvania hereby provides a 5-year limited warranty on our trailer frame and axles and a 2-year limited warrantee on the trailer as a whole. Sealant, electrical components, hydraulics, hoses, wall coverings, trim and paint are warranted for 1-year. The warrantor guarantees the product against defects in materials and workmanship. The warranty described in this agreement is in lieu of all other warranties, expressed or implied from **Ready2Go Restroom Trailers, LLC** or its suppliers. This warrantee shall apply to the retail consumer (original purchaser), as shown on the sales agreement.

Certain individual components are warranted by their respected manufacturers' warranties and therefore are excluded from the limited warranty provided by the warrantor. These components include, but are not limited to; tires, wheels, axles, couplers, jacks, light fixtures, windows, doors, heaters, air conditioners, toilets, sinks, faucets, pumps, etc. Warranty claims must be filed with the respective component manufacturers' warranty department.

This limited warranty is void if the product: 1. Is not properly maintained and/or inspected. 2. Is neglected, abused or misused. 3. Is overloaded or made to perform beyond recommended specifications.

The limited warranty is also void if damage results from continued use after a suspected defect is or should have been discovered. The warrantor reserves the right to make the final determination as to whether any of the above exclusions may nullify a warranty claim.

The warranty shall not pay nor make provisions for: 1. Service charges; towing charges; and transportation charges, which are the responsibility of the purchaser. 2. Loss of time, inconvenience; loss of use; rental substitution equipment; loss of revenue; or other commercial or personal loss. 3. Loss or damage to any and all contents. 4. Defacing; scratches; dents; chips; and tears, on any surface, not caused by the warrantor. Furthermore, the warrantor does not warranty any modification(s) made to either the interior or exterior of the product, even if damage occurs as a result of warranty claim. The warrant may not cover items that can be maintained or repaired using basic human skills in a short time; for example, tightening a leaky hose/pipe or other item, replacing/tightening screws, and other simple quick repair and maintenance type items.

Please refer to the products owner's manual, or authorized representative of the warrantor, for instructions on filing a warranty claim. The provisions of the limited warranty shall be interpreted and governed pursuant to the laws of the State of Pennsylvania.

CONSENT
AGENDA ITEM #

3

CONSENT AGENDA

ITEM 4



CITY OF PANAMA CITY BEACH AGENDA ITEM SUMMARY

1. DEPARTMENT MAKING REQUEST/NAME:

Parks and Recreation

2. MEETING DATE:

December 14, 2017

3. REQUESTED MOTION/ACTION:

Staff's recommendation is to approve the most responsive low bid from J.A. Dawson + Company, Inc in the amount of \$57,455.24.

4. AGENDA

PRESENTATION
PUBLIC HEARING
CONSENT
REGULAR

5. IS THIS ITEM BUDGETED (IF APPLICABLE)? Yes No N/A
BUDGET AMENDMENT OR N/A

DETAILED BUDGET AMENDMENT ATTACHED Yes No N/A

6. BACKGROUND: (WHY IS THE ACTION NECESSARY, WHAT GOAL WILL BE ACHIEVED)

On November 28, 2017, Staff received six (6) sealed bids for the Frank Brown Park Big Kids Playground Project. J.A. Dawson + Company, Inc was the most responsive low bid in the amount of \$57,455.24. Please see attachment.

In Attachment B of the Bid Packet you will find the planned Frank Brown Park Big Kids Playground location. With City Council approval, this Big Kids Playground project is planned to be completed by February 23, 2018.

After this project is approved, the next two projects of the overall playground rehab will be bid out next. As per the plans, the Little Rascals Toddler Playground for ages 4 and under and the Under the Palms Playground for ages 4 & up are expected to be completed by May 1, 2018. Each of those playgrounds will be handicap accessible.

All Playground projects for 2018 have been budgeted in the adopted 2017-2018 Budget.

The City Attorney, City Manager and Finance Director have reviewed and approve the recommendation to award J.A. Dawson + Company the Frank Brown Park Big Kids Playground Project bid in the amount of \$57,455.24.

CONSENT
AGENDA ITEM # 4

RESOLUTION 18-27

A RESOLUTION OF THE CITY OF PANAMA CITY BEACH, FLORIDA, APPROVING AN AGREEMENT WITH J.A. DAWSON & COMPANY, INC. IN THE AMOUNT OF \$57,455.24 FOR THE PURCHASE OF THE GAMETIME POWERSCAPE CITADEL TOWER FOR THE FRANK BROWN PARK BIG KIDS PLAYGROUND; AND PROVIDING AN IMMEDIATELY EFFECTIVE DATE.

BE IT RESOLVED that the appropriate officers of the City are authorized but not required to accept and deliver on behalf of the City that certain Agreement between the City and J.A. Dawson & Company, Inc. relating to the purchase of the GameTime PowerScape Citadel Playground for the Frank Brown Park Big Kids Playground in the basic amount of Fifty Seven Thousand Four Hundred Fifty Five Dollars and Twenty Four Cents (\$57,455.24), in substantially the form attached and presented to the Council today, with such changes, insertions or omissions as may be approved by the City Manager and whose execution shall be conclusive evidence of such approval.

THIS RESOLUTION shall be effective immediately upon passage.

PASSED in regular session this ___ day of _____, 2017.

CITY OF PANAMA CITY BEACH

By: _____
Mike Thomas, Mayor

ATTEST:

Jo Smith, City Clerk

Resolution 18-27

CONSENT
AGENDA ITEM # _____

H

11/28/17
2 PM

CITY OF PANAMA CITY BEACH
BID TABULATION

12/14/17
6 PM

Bidder	Address	Information	Price
Miracle Recreation Equipment Co			98,023.00
Top Line Recreation Inc			78,185.65
JA Dawson		Option 1	57,455.24
JA Dawson		Option 2	76,085.96
Playmore West Inc			82,527.57
Bliss Products			95,765.88

CONSENT
AGENDA ITEM #

4

#1

PROPOSAL FORM

TO: City of Panama City Beach, Florida
Frank Brown Park Big Kids Playground

SUBMITTED: Nov. 22, 2017.

The Undersigned, as Bidder, hereby declares that they have examined the proposal specifications and informed themselves fully in regard to all conditions pertaining to the equipment to be supplied.

The Bidder proposes and agrees, if this proposal is accepted, to contract with the City of Panama City Beach for the lump sum price listed, to furnish all labor, materials and supplies to install free and clear the Frank Brown Big Kids Playground in complete accord with the described and reasonably intended requirements of this request for proposals and the specifications submitted by Bidder to satisfaction of the City, with a definite understanding that no additional money will be allowed for any corrections or additions. Payment in full will be made to the Bidder within 30 days of delivery and completion of installation acceptable to the City. The Bidder further agrees hereby to complete the Frank Brown Park Big Kids playground install by February 23rd, 2018, with liquidated damages thereafter of \$200.00 per day.

Purchase will be made under terms and conditions specified by City in its form of a Purchase Order. If a deposit is required, it must be specified below. Final payment, in readily available funds, will be made upon acceptance by the City of strictly conforming goods after delivery and install. Strict adherence to design and specifications submitted by the Bidder and accepted by the City in writing will be is required.

ADDENDUM ACKNOWLEDGMENT: (Only if addendums have been provided). I, the undersigned bidder, hereby acknowledge receipt of the following addenda: Addendum No. ___ Addendum No. ___.

SUMMARY DESCRIPTION OF THE UNIT AND LUMP SUM PRICE:

Summary description of the Unit:
GameTime PowerScope Citadel Tower per drawing #02679-DS

Note: A detailed description not exceeding 7 pages, will include a photograph/sketch/drawing of the playground and a written description of the warranty of equipment meeting the minimum requirements of the bid specs must be attached to this Proposal.

Lump sum price for the Frank Brown Park Big Kids Playground: \$ 57,455.24.

Specify terms of any deposit or write "none required": none required.

Name of SUPPLIER: J.A. Dawson + Company, Inc

ADDRESS: Po Box 1178 CITY: Pelham STATE: AL ZIP: 35124

EMAIL ADDRESS: misbell@jadawsonco.com PHONE: 205.663.5058

SIGNATURE - (Confirming all information above is correct) Melissa T. Isbell

Print Name: Melissa T. Isbell and Print Title Project Manager

CONSENT
AGENDA ITEM # 4

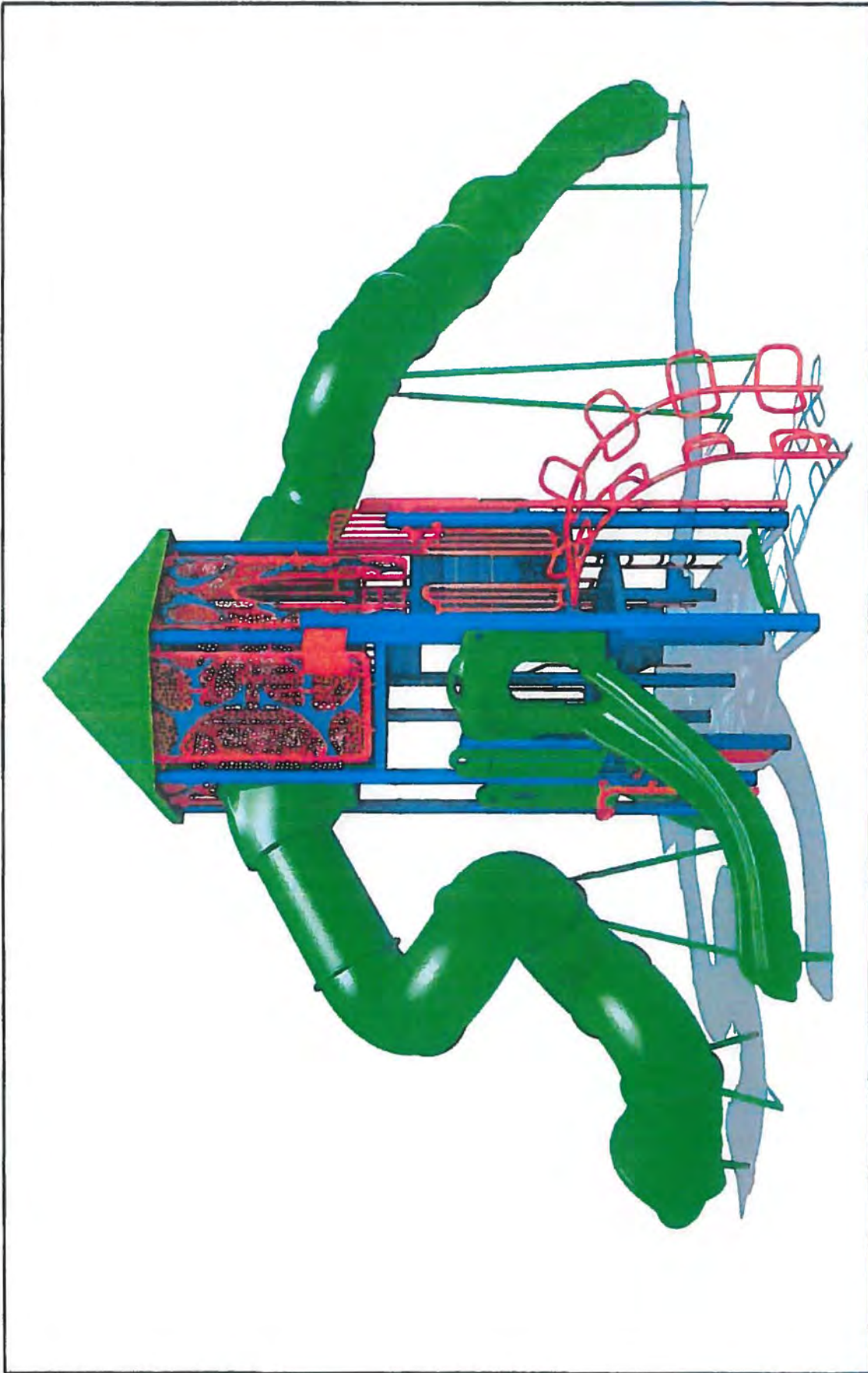

Frank Brown Park
Playground Option 1

J.A. Dawson
& Company
Your Total Recreation Resource

CONSENT
AGENDA ITEM #

4

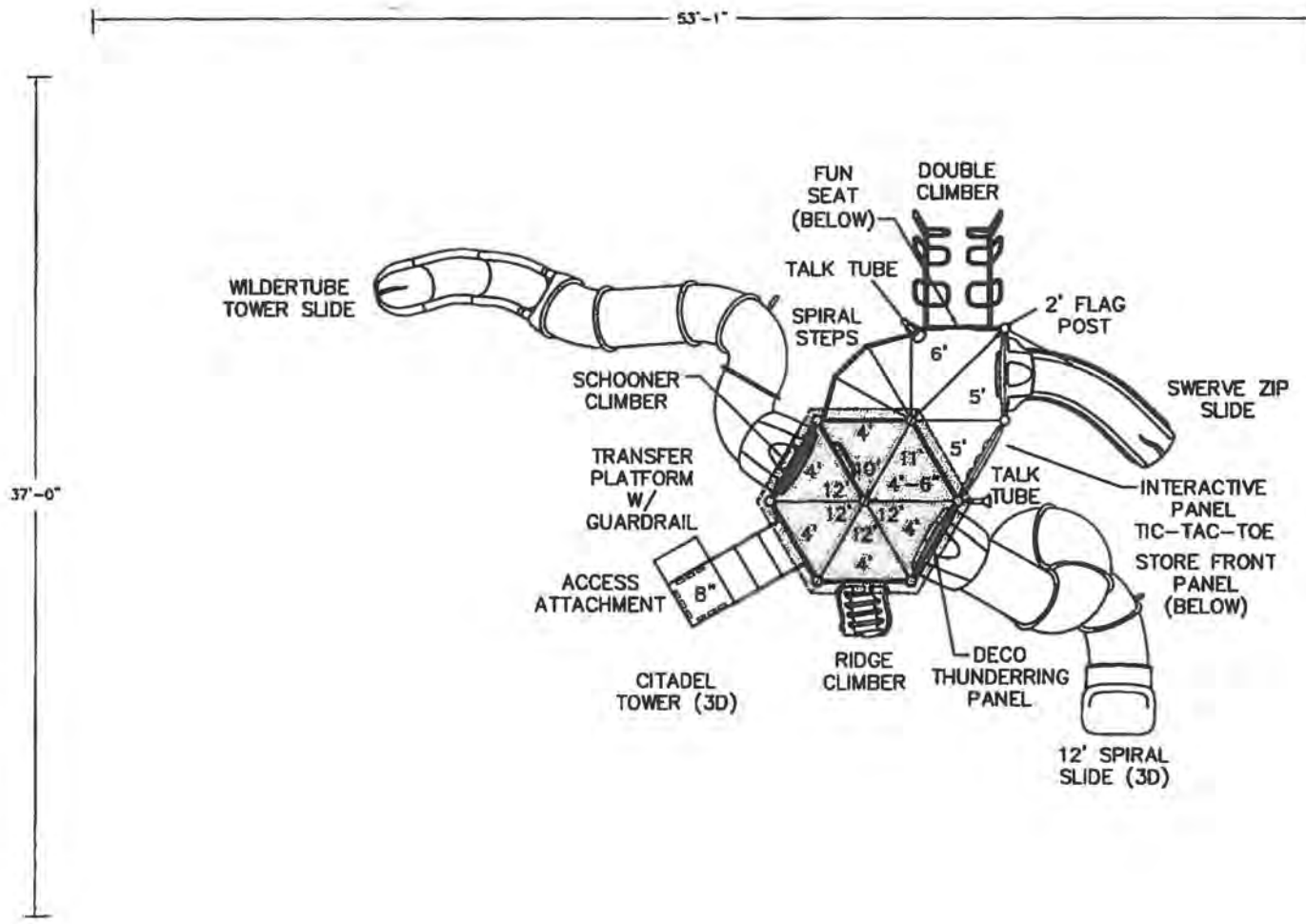

CONSENT
 AGENDA ITEM # 4

J.A. Dawson & Company
 Your Total Recreation Resource
 PO Box 1178
 Pellham, AL 35124
 205.863.5058
 800.221.8668
 f. 205863.5012
 www.jedawsonco.com

**Frank Brown Park
 Big Kids Playground**
 Project Manager:
John Kilpatrick

This play equipment is recommended for children ages
5-12

Minimum Area Required:
37' x 54'
 Scale: NTS
 This drawing can be scaled only when in an 8 1/2" x 11" format

IMPORTANT: Soft resilient surfacing should be placed in the use zones of all equipment, as specified for each type of equipment, and at depths to meet the critical fall heights as specified by the U.S. consumer Product Safety Commission, ASTM standard F 1487 and Canadian Standard CANCSA-Z-614

Drawn By:
M. Isbell
 Date:
11.20.2017
 Drawing Name:
02679-D5

150 PlayCore Drive, SE
Fort Payne, Alabama 35967
Telephone: 256/845-5610
Facsimile: 256/845-9361
Email: service@gametime.com



A PLAYCORE Company

GAMETIME[®] WARRANTIES

GameTime provides warranties on all materials and workmanship for one year, excluding vandalism.

In addition, GameTime offers:

- ✓ Lifetime limited warranty on PowerScape[®], PrimeTime[®] and Xscape[®] uprights.
- ✓ Lifetime limited warranty on all hardware.
- ✓ Lifetime limited warranty on GameTime PowerScape Tru-Loc[®] connections.
- ✓ Lifetime limited warranty on PrimeTime and Xscape bolt-through connections.
- ✓ Fifteen-Year limited warranty on metal decks, pipes, rungs, rails and loops.
- ✓ Fifteen-Year limited warranty on rotationally molded products.
- ✓ Five-Year limited warranty on glass fiber reinforced concrete PlayWorx structures.
- ✓ Five-Year limited warranty on glass fiber reinforced polymers Tuff Forms sculptures.
- ✓ Twenty-Year limited warranty on Timber Décor[™] & Timbers recycled plastic lumber.
- ✓ Five-Year limited warranty on nylon-covered cable net climbers and components.
- ✓ Ten-Year limited warranty on pressure-treated pine and redwood products.
- ✓ Ten-Year limited warranty on Advanced, Elite & stationary Base Series posts & bars.
- ✓ Ten-Year limited warranty on site furnishings.
- ✓ Ten-Year limited warranty on integrated GTShade[®] products.
- ✓ Ten-Year limited warranty on fiberglass and DHPL signage.
- ✓ Five-Year limited warranty on Super Seats[™].
- ✓ Three-Year limited warranty on SaddleMates[®] rubber and "C"-springs.
- ✓ One-Year limited warranty on all other GameTime products.

All warranties specifically exclude damage caused by vandalism; negligence, improper installation or improper use; changes in appearance resulting from weathering; scratches, dents or marring as a result of use. Warranties are valid only if products are installed and maintained in accordance with GameTime instructions and use approved parts.

LIMITED WARRANTY ON PLAYWORX GFRC THEMED PLAY STRUCTURES

GameTime provides a five-year limited warranty on PlayWorx glass fiber reinforced concrete (GFRC) themed play structures against structural failure that cause the product to become structurally unfit for the intended use and a one-year limited warranty on paint defects; see exclusions. This warranty does not cover damage resulting from ground settlement or high winds.

LIMITED WARRANTY ON TUFF FORMS GFRP THEMED PLAY SCULPTURES

GameTime provides a five-year limited warranty on Tuff Forms glass fiber reinforced polymers (GFRP) themed play sculptures against structural failure that cause the product to become structurally unfit for the intended use and a one-year limited warranty on paint defects; see exclusions. This warranty does not cover damage resulting from ground settlement or high winds.

LIMITED WARRANTY ON FITNESS EQUIPMENT

GameTime provides a ten-year limited warranty on GTfit Advanced, Elite and stationary Base Series posts, welds, and bars and a five-year limited warranty on motion Base Series posts, welds, and bars against structural failure; a five-year limited warranty on Advanced Series stainless damper modules and aluminum cycle covers; a two-year limited warranty on Advanced and motion Base Series bearings, steel pins, dampers, plastics, rubber parts, cycle pedals and shafts, molded seats, backrests and clamps; and a one-year limited warranty on cycle rib belts and powder coating. These warranties cover damage due to failure or corrosion of metal parts that cause the product to become structurally unfit for the intended use; see exclusions.

TEN-YEAR LIMITED WARRANTY ON REDWOOD AND PRESSURE-TREATED WOOD PRODUCTS

GameTime provides a ten-year limited warranty on redwood and pressure-treated wood products against damage by decay or termites causing the wood to become structurally unfit for its intended use; see exclusions.

FIVE YEAR LIMITED WARRANTY ON GAMETIME SUPER SEAT™

GameTime provides a five-year limited warranty on Model No. 949 SuperSeat and Model No. 999 Super Seat-2 against structural failure that causes the seat to become unfit for its intended use; see exclusions. The factory installed "S"-Hook and Seat Hanger assemblies are covered under a one-year limited warranty against rust, corrosion or premature wear.

THREE-YEAR LIMITED WARRANTY ON RUBBER AND "C" SPRINGS FOR SADDLEMATES®

GameTime provides a three-year limited warranty on rubber and "C"-springs for SaddleMates against damage due to de-lamination of the rubber spring and breakage of the "C"-spring that cause the SaddleMate to become structurally unfit for its intended use; see exclusions.

For the purposes of this warranty, lifetime encompasses no specific term of years, but rather that Seller warrants to its original customer for as long as the original customer owns the Product and uses the Product for its intended purpose that the Product and all parts will be free from defects in material and manufacturing workmanship.

GameTime excludes from these warranties the cost to remove parts and reinstall replacements; replacement due to cosmetic defects or coating deterioration caused by climatic conditions; and wood replacement resulting from twisting, warping, checking, shrinking, swelling or other natural physical properties of wood.

To the extent permitted by law, these warranties are expressly in lieu of any other implied or expressed warranties or representation by any person, including any implied warranty of merchantability or fitness. These warranties provide valuable rights to you. No Sales Representative can modify or amend the terms of this warranty.

Since warranty limitations and exclusions may vary from state to state, you should check any specific warranty rights in your state.



IPEMA ASTM F1487-11 CERTIFICATE OF COMPLIANCE

ISSUE DATE: November 21, 2017

Requested By: Melissa

Project: Frank Brown Park Option 1

In the interest of public playground safety, IPEMA provides a third-party certification service whereby TÜV SÜD America validates a manufacturer's certification of conformance to the ASTM F1487-11 (excluding sections 7.1.1, 10, 12.6.1, 13.2, and 13.3) Standard Consumer Safety Performance Specification for Playground Equipment for Public Use.

The manufacturer listed below has received written validation from TÜV SÜD America that the product(s) listed conform with the requirements of ASTM F1487-11 (excluding sections 7.1.1, 10, 12.6.1, 13.2, and 13.3).

This certificate is invalid if any component or part is replaced, unless purchased from the original manufacturer and assembled in accordance with the original equipment manufacturer's instructions. Check with the manufacturer to determine the validity of the certification of the product(s) listed prior to using this certificate for proof of certification.

PRODUCT	PRODUCT LINE	MANUFACTURER	DESCRIPTION
81677	Powerscape	GameTime	TALK TUBE, PLATFORM ACCESS
80657	Powerscape	GameTime	ACCESS ATTACHMENT
80001	Powerscape	GameTime	PLATFORM, TRIANGULAR
81666	Powerscape	GameTime	Fun Seat
90355	Powerscape	GameTime	Storefront Panel
90269	Powerscape	GameTime	Upright Aluminum 11'
90271	Powerscape	GameTime	Upright Aluminum 13'
G90272	Powerscape	GameTime	Upright Galvanized 14'
90526	Powerscape	GameTime	Flag Post 2'
90203	Powerscape	GameTime	Interactive Panel (Tic-Tac-Toe)
90105	Powerscape	GameTime	Schooner Climber 3'-6" & 4'
90033	Powerscape	GameTime	Transfer Platform W/Guardrail 4'
90338	Powerscape	GameTime	Double Climber, 5'-6" thru 6'-6"
90226	Powerscape	GameTime	Decorative Panel W/Thundering
90578	Powerscape	GameTime	Swerve Slide
90592	Powerscape	GameTime	Ridge Climber
91208	Powerscape	GameTime	Climber Entryway (Guardrail)
91209	Powerscape	GameTime	Climber Entryway (Barrier)
81767	Powerscape	GameTime	Talk Tube Attachment (Ground Level)
3966RP	PlayWorx	GameTime	4' Spiral Steps W/Filler Plate (Reverse)
3964RP	PlayWorx	GameTime	Panel Enclosure
3967RP	PlayWorx	GameTime	Citadel Tower
3963RP	PlayWorx	GameTime	12' Spiral Slide W/Slide Panel
80729	Powerscape	GameTime	12" Stepped Platform
4337RP	PlayWorx	GameTime	Wildertube Tower Slide Reverse



PowerScape: Our premier 5" play system for ultra-tough durability.

EVERYTHING YOU WANT FROM A PLAY SYSTEM

- ✓ 5" diameter uprights available in aluminum or galvanized steel
- ✓ Choose from an extensive offering of exclusive components and signature products
- ✓ Lifetime limited warranty on uprights, posts and hardware
- ✓ NEW Tru-Loc® offers streamlined connections with 50% less hardware for easier construction and maintenance
- ✓ Largest decks in the industry and slip-resistant Tuff Clad™ deck coatings for increased footing
- ✓ Entry archways to help direct traffic and prevent inadvertent falls
- ✓ Tough, baked-on powder coat finish
- ✓ Exclusive Direct bolt technology.
- ✓ IPEMA certified



PowerScape playgrounds can be customized with shade structures, freestanding play activities and ramps for accessibility, including the widest ramps in the industry

THE TRU-LOC ADVANTAGE

Our patented Tru-Loc® is far superior to the average "clamp around" system!

- ✓ Next generation direct bolt features elegant, innovative engineering
- ✓ Connection offers sleeker lines and cleaner designs
- ✓ Tru-Loc® Panel Connector is ASTM/EN/CSA compliant
- ✓ Smooth "kid-friendly" connection point, no rough edges
- ✓ Connections are concealed within the sleeve, no exposed hardware
- ✓ Unlike clamp systems, our systems don't require precise field measuring and constant maintenance



4



**STATE OF FLORIDA
DEPARTMENT OF BUSINESS AND PROFESSIONAL REGULATION**

**CONSTRUCTION INDUSTRY LICENSING BOARD
2601 BLAIR STONE ROAD
TALLAHASSEE FL 32399-0783**

(850) 487-1395

**KILPATRICK, JOHN PAUL
J.A. DAWSON & CO., INC.
PO BOX 1178
PELHAM AL 35124**

Congratulations! With this license you become one of the nearly one million Floridians licensed by the Department of Business and Professional Regulation. Our professionals and businesses range from architects to yacht brokers, from boxers to barbeque restaurants, and they keep Florida's economy strong.

Every day we work to improve the way we do business in order to serve you better. For information about our services, please log onto www.myfloridalicense.com. There you can find more information about our divisions and the regulations that impact you, subscribe to department newsletters and learn more about the Department's initiatives.

Our mission at the Department is: License Efficiently, Regulate Fairly. We constantly strive to serve you better so that you can serve your customers. Thank you for doing business in Florida, and congratulations on your new license!



**STATE OF FLORIDA
DEPARTMENT OF BUSINESS AND
PROFESSIONAL REGULATION**

CBC1258579 ISSUED: 08/28/2016

**CERTIFIED BUILDING CONTRACTOR
KILPATRICK, JOHN PAUL
J.A. DAWSON & CO., INC.**

**IS CERTIFIED under the provisions of Ch 489 FS.
Expiration date AUG 31, 2018 L1608280002344**

DETACH HERE

RICK SCOTT, GOVERNOR

KEN LAWSON, SECRETARY

**STATE OF FLORIDA
DEPARTMENT OF BUSINESS AND PROFESSIONAL REGULATION
CONSTRUCTION INDUSTRY LICENSING BOARD**

LICENSE NUMBER	
CBC1258579	

**The BUILDING CONTRACTOR
Named below IS CERTIFIED
Under the provisions of Chapter 489 FS.
Expiration date: AUG 31, 2018**



**KILPATRICK, JOHN PAUL
J.A. DAWSON & CO., INC.
220 APPLIGATE TRACE
PELHAM AL 35124**



ISSUED: 08/28/2016

DISPLAY AS REQUIRED BY LAW

**SEQ # L1608280002344
CONSENT
AGENDA ITEM #**

4

REQUEST FOR PROPOSALS

Frank Brown Park BIG KIDS PLAYGROUND

CITY OF PANAMA CITY BEACH, FLORIDA

November 1, 2017



CONSENT
AGENDA ITEM #

4

**NOTICE OF
REQUEST FOR SEALED PROPOSALS**

**Frank Brown Park
Big Kids Playground**

The City of Panama City Beach hereby solicits sealed proposals for a Big Kids Playground for ages 7 & up to be located in the Playground area of Frank Brown Park in the City of Panama City Beach.

Sealed proposals will be received until **2:00PM Central Daylight Time, November 28th, 2017**, at the City of Panama City Beach City Hall Annex, 110 S Arnold Road, Panama City Beach, Florida 32413 and will be opened and publicly read immediately thereafter. All Bids shall be submitted in an envelope clearly marked "Sealed Bid- Panama City Beach – Frank Brown Park Big Kids Playground."

Copies of the specifications may be obtained from the Parks & Recreation Office at 16200 PCB Parkway or on the City's Website at www.pcbgov.com. The point of contact for obtaining specifications is Cheryl Joyner, email address cjoyner@pcbgov.com. No specifications will be issued to suppliers later than seventy-two (72) hours prior to the time indicated above for receiving bids.

Proposals must be submitted upon the standard form contained in the Specifications with such attachments as may be authorized there.

The City reserves the right to (1) reject any and all bids and to waive any informality in bids received, and (2) to award the contract to a bidder other than the lowest bidder should it find that the lowest bidder does not offer the reliability, quality of service or product afforded by such other bidder. Where a bid other than the lowest bid is taken, the City Council will state the reasons upon which such award was made. All bidders shall comply with all applicable state and local laws concerning licensing, registration, and regulations of businesses in the state of Florida.

All Bids shall be firm for a period of 60 days after opening.

END.

PROPOSAL FORM

TO: City of Panama City Beach, Florida

SUBMITTED: _____, 2017.

Frank Brown Park Big Kids Playground

The Undersigned, as Bidder, hereby declares that they have examined the proposal specifications and informed themselves fully in regard to all conditions pertaining to the equipment to be supplied.

The Bidder proposes and agrees, if this proposal is accepted, to contract with the **City of Panama City Beach** for the lump sum price listed, to furnish all labor, materials and supplies to install free and clear the Frank Brown Big Kids Playground in complete accord with the described and reasonably intended requirements of this request for proposals and the specifications submitted by Bidder to satisfaction of the City, with a definite understanding that no additional money will be allowed for any corrections or additions. Payment in full will be made to the Bidder within 30 days of delivery and completion of installation acceptable to the City. The Bidder further agrees hereby to complete the Frank Brown Park Big Kids playground install by **February 23rd, 2018**, with liquidated damages thereafter of \$200.00 per day.

Purchase will be made under terms and conditions specified by City in its form of a Purchase Order. If a deposit is required, it must be specified below. Final payment, in readily available funds, will be made upon acceptance by the City of strictly conforming goods after delivery and install. Strict adherence to design and specifications submitted by the Bidder and accepted by the City in writing will be is required.

ADDENDUM ACKNOWLEDGMENT: (Only if addendums have been provided). I, the undersigned bidder, hereby acknowledge receipt of the following addenda: Addendum No.____ Addendum No.____.

SUMMARY DESCRIPTION OF THE UNIT AND LUMP SUM PRICE:

Summary description of the Unit:

Note: A detailed description not exceeding 7 pages, will include a photograph/sketch/drawing of the playground and a written description of the warranty of equipment meeting the minimum requirements of the bid specs must be attached to this Proposal.

Lump sum price for the Frank Brown Park Big Kids Playground: \$_____.

Specify terms of any deposit or write "none required": _____.

Name of SUPPLIER: _____

ADDRESS: _____ CITY: _____ STATE: _____ ZIP: _____

EMAIL ADDRESS: _____ PHONE: _____

SIGNATURE – (Confirming all information above is correct) _____

Print Name: _____ and Print Title _____

Frank Brown Park Big Kids Playground

PART 1 - GENERAL DESCRIPTION

Outdoor Big Kids Playground for kids ages 7 and up. Playground will consist of stairs on one side and a climber on the other side that goes up to a enclosed tower area. There will be a minimum of one 12 foot slide preferably a tube slide and a second slide at a minimum of 10 foot that is either a tube slide or open air. All enclosed towers will have a roof for shade. The Big Kids Playground structure will include a Talking Tube type of speaker at the top of the Big Kids Playground tower area and a Talking Tube type of speaker at the bottom for the ability to communicate with individuals. The enclosed tower at the top will also include at the minimum the following items: 1. Interactive game type of play structure attached to one of the panels. 2. A climber or a crawl tube and 3. A small flag like item on the outside of the enclosed tower that is controlled by a lever inside the tower allowing children to raise and lower the small flag like item.

PART 2 – CERTAIN TERMS AND CONDITIONS

- 1) Delivery and installation **must be completed by February 23rd, 2018**, with liquidated damages of \$200.00 per day thereafter.
- 2) Minimum bidder's 12-month warranty on installation parts and labor.
- 3) Minimum manufacturers' 12-month warranty on the Playground Structure.
- 4) A minimum of a 10-year manufacturers' warranty against chipping, rusting, delaminating, and fading of structure.
- 5) A minimum of a 10-year warranty on punched steel decks, pipes, rails, roofs, loops, rungs, rotomolded and polyethylene components.
- 6) Lifetime warranty on support posts (uprights), tru-locks and hardware.
- 7) Playground will be installed by the bidder and it is the bidder's responsibility to confirm the measurement and suitability of the playground including without limitation dimensions, composition, fall height and structural integrity.
- 8) The surfacing will consist of sand at a minimum of 12 inches and will be the City's responsibility after the install of the Big Kids Playground.
- 9) Playground location will be leveled and graded by the City prior to installation.
- 10) The color desired is royal blue, green and orange, but color choice can be changed with City Approval.
- 11) Submit a drawing/picture/sketch of the proposed playground with bid. If it is determined that the proposed design of equipment is not appropriate for our playground, The City reserves the right to not consider the proposal. (Exhibit C - Examples of possible playground structures that would work for this location).
- 12) The measurement of the playground area is approximately 75 feet long by 50 feet wide.(Exhibit B)
- 13) The Big Kids Playground will be certified and meet ASTM-F1487, CPSC and IPEMA standards for playgrounds.
- 14) The City is tax exempt and copy of the certificate of exemption is attached as (Exhibit A).
- 15) After playground is installed and is acceptable to the city, payment in full will be made within 30 days of receipt of invoice for the approved bid amount. Invoice and W9 shall be submitted in digital Adobe Acrobat .pdf format to Cheryl Joyner Recreation Administration Supervisor at cjoyner@pcbgo.com.

- 16) The budget must not exceed \$100,000 which includes installation. This is a low bid process.
- 17) Job Walks can be scheduled by an appointment by contacting Cheryl Joyner, City of Panama City Beach Recreation Administration Supervisor at cjoyner@pcb.gov.

PART 3 – DATES

1. Sealed Proposals Due Tuesday November 28th, 2017 at 2:00pm at City Hall Annex, 110 South Arnold Road, Panama City Beach.
2. Proposals will be opened at 2:00 pm at that same time and place.
3. City Council Approval December 14th, 2017.
4. Job awarded December 15th, 2017.
5. Job to be completed by February 23, 2018.

PART 4 – LIST OF RFP EXHIBITS

EXHIBIT A

Certificate of Tax Exemption

EXHIBIT B

Location of where the Big Kids Playground structure will be installed

EXHIBIT C

Examples of possible Big Kids Playgrounds that would work for this location

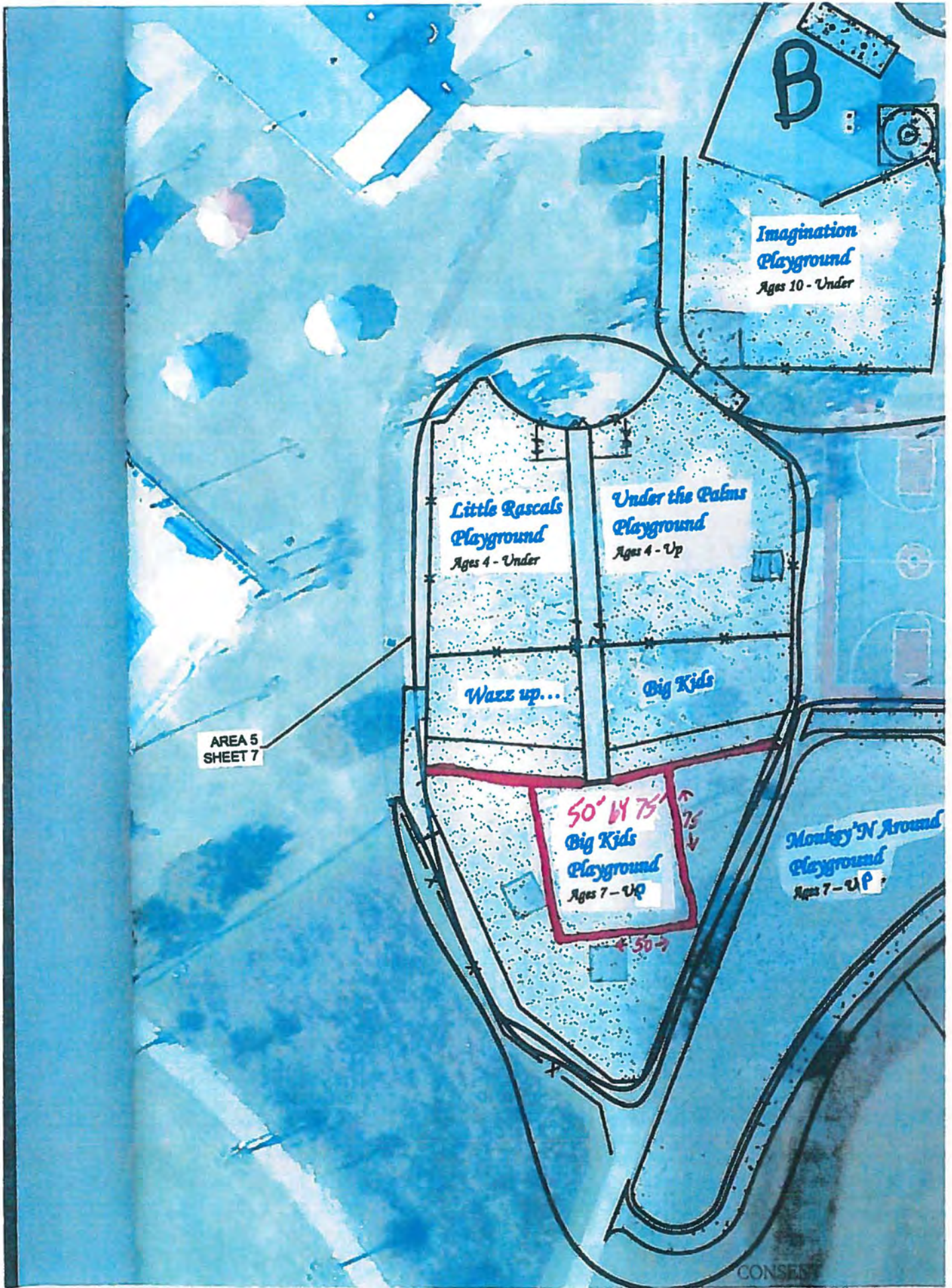

AREA 5
SHEET 7

*Imagination
Playground*
Ages 10 - Under

*Little Rascals
Playground*
Ages 4 - Under

*Under the Palms
Playground*
Ages 4 - Up

Wazz up...

Big Kids

50' x 75'
*Big Kids
Playground*
Ages 7 - Up

*Monkey 'N' Around
Playground*
Ages 7 - Up

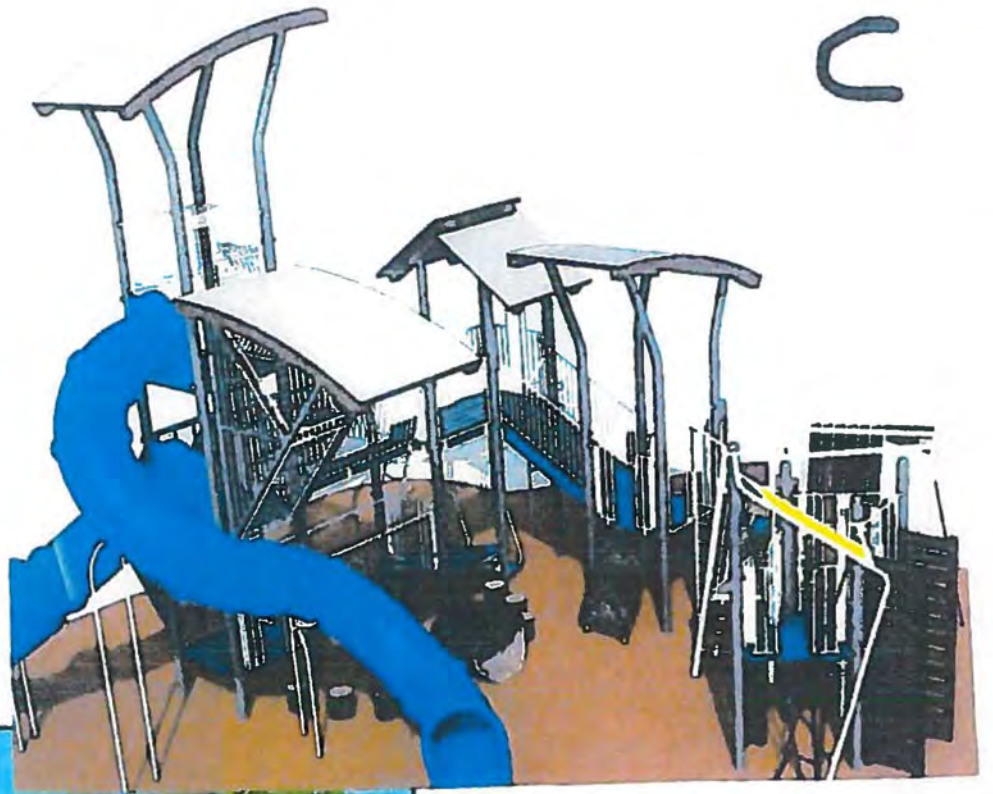

C



CONSENT
AGENDA ITEM # _____ 4

CONSENT AGENDA

ITEM 5



CITY OF PANAMA CITY BEACH AGENDA ITEM SUMMARY

1. DEPARTMENT MAKING REQUEST/NAME:
Utilities Department - Al Shortt, Utilities Director

2. MEETING DATE:
December 14, 2017

3. REQUESTED MOTION/ACTION:
Approve a purchase order in the amount of \$13,650 for the purchase and delivery of one Ground Penetrating Radar.

4. AGENDA
PRESENTATION
PUBLIC HEARING
CONSENT
REGULAR

5. IS THIS ITEM BUDGETED (IF APPLICABLE)? Yes No N/A
BUDGET AMENDMENT OR N/A

DETAILED BUDGET AMENDMENT ATTACHED Yes No N/A

6. BACKGROUND: (WHY IS THE ACTION NECESSARY, WHAT GOAL WILL BE ACHIEVED)

City utilities are currently located by using a metal detector to find the locating wire placed on the pipe. The depth is then found by manually probing the ground above the pipe with a shovel or a post hole digger. A ground penetrating radar can locate the depth of the pipe, as well as the diameter by rolling across the ground above and scanning the subsurface. The acquisition of this piece of equipment will allow our employees to locate utilities more quickly and efficiently, while simultaneously reducing the potential for injury.

City staff prepared bid documents for the supply and delivery of a ground penetrating radar unit. A solicitation for bids was publicly advertised and one bid was received. The Bid Tabulation is attached to this document.

This project is currently budgeted and the proposed expenditure is within the budgeted amount. Staff has reviewed the bid and recommends award of the purchase order to Green Equipment Co. in the amount of \$13,650.

WHY - To allow the City Manager to enter into a contract for the purchase and delivery of one Ground Penetrating Radar in the amount of \$13,650.

WHAT - To locate utilities in the most efficient manner possible.

CONSENT
AGENDA ITEM # 5

RESOLUTION 18-29

A RESOLUTION OF THE CITY OF PANAMA CITY BEACH, FLORIDA APPROVING THE PURCHASE OF A PORTABLE GROUND PENETRATING RADAR FROM GREEN EQUIPMENT COMPANY IN THE BASIC AMOUNT OF \$13,650.

BE IT RESOLVED that the appropriate officers of the City are authorized but not required to execute and deliver on behalf of the City that certain Agreement between the City and Green Equipment Company, relating to the purchase of a portable ground penetrating radar, in the basic amount of Thirteen Thousand Six Hundred Fifty Dollars (\$13,650.00), in substantially the form attached and presented to the Council today, with such changes, insertions or omissions as may be approved by the City Manager, whose execution of such agreement shall be conclusive evidence of such approval.

THIS RESOLUTION shall be effective immediately upon passage.

PASSED in regular session this ___ day of _____, 2017.

CITY OF PANAMA CITY BEACH

By: _____
Mike Thomas, Mayor

ATTEST:

Jo Smith, City Clerk

Resolution 18-29

CONSENT
AGENDA ITEM # _____

5

BID TABULATION
GROUND PENETRATING RADAR
CITY OF PANAMA CITY BEACH, FLORIDA

December 5, 2017
2:00 PM

BIDDER	CONTACT INFORMATION	Basis of Award
Green Equipment Company	459 Main Street, Ste 101-128 Trussville, Alabama 35173 205-565-9265 jasonwiley@greenequipco.com	\$ 13,650.00

CONSENT
AGENDA ITEM #

5

CONSENT AGENDA

ITEM 6



CITY OF PANAMA CITY BEACH AGENDA ITEM SUMMARY

1. DEPARTMENT MAKING REQUEST/NAME:

Utilities Department - Al Shortt, Utilities Director

2. MEETING DATE:

December 14, 2017

3. REQUESTED MOTION/ACTION:

Approve the repair of a radiator for a Utility system diesel powered electric generator by TAW Power Systems, Inc.

4. AGENDA

PRESENTATION
PUBLIC HEARING
CONSENT
REGULAR

5. IS THIS ITEM BUDGETED (IF APPLICABLE)? YES NO
BUDGET AMENDMENT OR N/A

N/A

DETAILED BUDGET AMENDMENT ATTACHED YES NO

N/A

6. BACKGROUND: (WHY IS THE ACTION NECESSARY, WHAT GOAL WILL BE ACHIEVED)

The City has three very large diesel driven electric generators at its Wastewater Treatment Facility on North Gulf Boulevard that can be used to power the effluent pump station. The units are critical components of the facility and provide emergency electrical power enabling staff to continue operating the pump station in the event of an outage from Gulf Power Company. One of these generator units has developed a coolant leak due to a corroded radiator and has been taken out of service. The radiator needs to be removed, repaired and reinstalled. Staff solicited proposals from companies able to provide the specialized generator service work needed and received three responses. Copies are attached for your review. The low bid is from TAW Power Systems, Inc. in the amount of \$14,740.54. Staff recommends that City Council authorize the City Manager to enter into an agreement with the low bidder to complete the work.

WHY - To allow the City Manager to enter into an agreement for the repair of of the radiator for a diesel powered electric generator at the City Wastewater Treatment Facility.

WHAT - Allow the Utility system to have the necessary redundant power systems available to operate equipment in accordance with applicable regulations.

CONSENT
AGENDA ITEM # 6

RESOLUTION 18-30

A RESOLUTION OF THE CITY OF PANAMA CITY BEACH, FLORIDA, APPROVING THE PURCHASE FROM TAW POWER SYSTEMS, INC. RELATING TO THE REPAIR OF A DIESEL POWERED ELECTRIC GENERATOR AT THE CITY'S WASTEWATER TREATMENT FACILITY IN THE TOTAL AMOUNT OF \$14,740.54; AND PROVIDING AN IMMEDIATELY EFFECTIVE DATE.

BE IT RESOLVED that the appropriate officers of the City are authorized but not required to accept and deliver on behalf of the City that certain Agreement between the City and TAW Power Systems, Inc., relating to repair of a diesel powered electric generator at the City's Wastewater Treatment Facility, in the total amount of Fourteen Thousand Seven Hundred Forty Dollars and Fifty Four Cents Dollars (\$14,740.54), in substantially the form attached and presented to the Council today, with such changes, insertions or omissions as may be approved by the City Manager and whose execution shall be conclusive evidence of such approval.

THIS RESOLUTION shall be effective immediately upon passage.

PASSED in regular session this ___ day of _____, 2017.

CITY OF PANAMA CITY BEACH

By: _____
Mike Thomas, Mayor

ATTEST:

Jo Smith, City Clerk

Resolution 18-30
CONSENT
AGENDA ITEM # _____ *6*

KOHLERGENERATORS

TAW POWER SYSTEMS-MOBILE
 5365 Willis Road Theodore AL 36582
 866-860-8267 FAX: 251-853-4483

KOHLER POWER SYSTEMS DISTRIBUTOR FOR ALABAMA, SOUTH GEORGIA, FLORIDA, LOUISIANA AND MISSISSIPPI, ALSO PROVIDING SERVICE ON KOHLER AND ALL OTHER MAKES AND MODELS.

Attention: Stephen Parris
 City of Panama City Beach (COPCB)
 COPCB Wetlands Pumping Station Gen #3
 206 Noth Gulf Blvd.
 Panama City Peach FL 32413

PROPOSAL Remove and Repair Radiator + E-Coating

Date: 9/20/2017
 SC# MO 501
 Proposal # MJ-26521-02102

To: Stephen Parris

For your review and consideration, we are providing a proposal for services requested as described for your.

Generac 500KW Model: 12328390800 Serial Number: 2108260

DESCRIPTION

Coordination must be done with C,G&J to be on site the day the Radiator is being removed so they can transport it to their shop for repair.

Day #1: Drain Coolant and remove all parts needed to pull radiator. Remove the housing Panel above the radiator to allow removal of radiator. Boom Truck will be supplied and operated by Customer. Install lifting eye bolts on top of radiator and have boom truck remove the radiator assembly. Place the assembly on C,G&J Truck or Trailer. Re-install the Generator Housing roof Panel to prevent rain from entering the housing. After Repair and E-Coating, C,G&J must Coordinate with us to be onsite to re-install the radiator. Day #2: Lift the radiator back into the generator with the Boom truck. Reconnect all removed components and refill the cooling system. Run the generator to operating temperature to verify there are no coolant leaks.

TAW Periodic Maintenance Agreement repairs Terms and Conditions apply (See Attachment)

CG&J: Warranty Radiator Repair: Is one Year parts and Labor on the recor and 5 yearson the E-Coated Radiator Core against Environmental Damage.

Recoring & E-Coating	\$	11,860.54
Labor for Removal and Install	\$	2,880.00
Mileage Charge	\$	-
Sub-Total	\$	14,740.54
Tax	\$	-
TOTAL	\$	14,740.54

Any sales tax due on work will be calculated and included in final invoice unless a valid tax-exempt certificate has been supplied and is on file.

- Proposal does not include any additional work or material required due to unforeseen problems that may be discovered after work has begun.
- TAW is not responsible for any permitting that may be required to perform any of the services described above.
- This proposal is separate from any previous proposal written or implied, and requires authorization and purchase order to proceed.
- Jobs that require special order parts will not go on the schedule until parts are in at a TAW warehouse. A temporary date may be given and is subject to change.
- A 25% restocking fee will be charged to all canceled proposals along with any freight charges incurred from any special ordered parts.
- This Proposal is offered with TAW Power Systems, Inc. PERIODIC MAINTENANCE AGREEMENT/ REPAIRS TERMS AND CONDITIONS . A copy is available upon request.
- Unless otherwise stated, proposal includes above parts, disposal of all waste materials, shipping/handling and labor to perform job described

Sincerely, Joseph T. Johnson

 Joseph Johnson / Aftermarket Sales Representative
 cell: 950-428-1010 e-mail: Joseph.Johnson@tawinc.com

CUSTOMER ACKNOWLEDGMENT TO PROCEED

NAME _____ DATE _____
 TITLE _____ P.O. _____

PROPOSAL GOOD FOR 30 DAYS

All TAW plans, specifications, and technical drawings are copyrighted works and contain proprietary know-how of TAW, and Buyer has no right to reproduce, distribute, or publish copies of TAW's copyrighted works or to create derivative works of TAW's copyrighted works without the express written permission of an authorized representative of TAW.

CONSENT
 AGENDA ITEM # 6



Sales and Service

LOCATION: 010

PLANNED MAINTENANCE AGREEMENT

<u>Customer Address</u>	<u>Customer Contact</u>	<u>Quote Information</u>
CITY OF PANAMA CITY BEACH 104 S. ARNOLD ROAD Panama City Bea, FL 32413	Contact: Stephen Parris Phone: 850 233-5050 Fax: Cust Id: 8511695	Quote Date: 20-SEP-17 Quote Expires: 31-DEC-17 Quote Num: 35325 Quoted By: Charles A Sizemore

Site Information

1	PMA-WATERPLANT	206 N GULF BLVD	PANAMA CITY BEFL	32413
---	----------------	-----------------	------------------	-------

<u>Site Unit Number</u>	<u>Manufacturer</u>	<u>Model</u>	<u>Prod Model</u>	<u>Serial Number</u>	<u>Type</u>	
1	2108260	GENERAC	GENSET	12328390800	#3	500KW

<u>Site Unit Number</u>	<u>Service Event</u>	<u>Qty</u>	<u>Sell Price</u>	<u>Extended Price</u>	
1	2108260	OTHER	1	14,796.00	14,796.00

Scope of Work:

1. Drain radiator and remove all parts needed for the removal of radiator, remove housing panel above radiator
2. Remove radiator and ship to repair facility
3. Radiator shop to strip radiator down sand blast to clean, rebuild unit and coat for corrosion
4. Ship repaired radiator back and reinstall radiator and all componenets removed. Refill radiator
5. Run generator to operating temperature and check for leaks

Bid Pricing Breakdown:

1. Re-Core Charge- \$12,312.00
2. Labor Charge- \$1,360.00
3. Mileage Charge- \$324.00
4. Environmental Fees- \$50.00
5. Shipping Fees- \$750.00

Warranty:

Radiator Repair Product to be free from defects in material and workmanship for 12 months from date of shipment to the original consumer purchaser This warranty covers any parts and workmanship furnished with regards to the radiator re-core repair Removal and Installation Worksmanship Worksmanship covered for a period of 6 months from work completion.

- * Any applicale taxes not included in pricing and will be charged additionally
- * Pricing does not include boom truck for removal or installation of radiator, to be provided by the customer.
- * Any items found in need of additional repair or replacement during the radiator repair will be quoted and performed additionally.

Unless otherwise specified, first service is due to be performed within 30 days of PMA signature. Signature below acknowledges and accepts the Terms and Conditions on the back of this Agreement.

Purchase Order Number and Signature required.

Signature: _____ Print Name: _____

Purchase Order Number: _____

Please Provide name and e-mail address of each site contact:

Site: Name: _____ E-Mail: _____

Quote



Energy Systems Southeast, LLC
 3235 Veterans Circle
 Birmingham, AL 35235
 2055202183

Order Number: 0151378
 Order Date: 9/19/2017

Salesperson: JM
 Customer Number: 50-PANAMAC

Sold To:
 City of Panama City Water Dept
 110 South Arnold
 Panama City Beach, FL 32413

Ship To:
 Panama City Water Department
 Reuse to Wailand System
 208 North Gulf Blvd
 Panama City Beach, FL 32413

Confirm To:
 ANGEL AGEE

Customer P.O.	Ship VIA	F.O.B.	Terms 30 days
---------------	----------	--------	------------------

Item Number	Unit	Ordered	Shipped	Back Order	Price	Amount
-------------	------	---------	---------	------------	-------	--------

QUOTE TO REMOVE, RECORE AND REPLACE RADIATOR , WILL REQUIRE 2 TECHS,
 CUSTOMER TO SUPPLY BOOM TRUCK AND INSTALLATION OF RADIATOR

*****SCOPE OF WORK*****

1. DRAIN RADIATOR AND REMOVE ALL PARTS NEEDED FOR REMOVAL OF RADIATOR, REMOVE RAHOUSING PANEL ABOVE RADIATOR
2. REMOVE RADIATOR AND SHIP TO REPAIR FACILITY
3. RADIATOR SHOP TO STRIP RADIATOR DOWN, SAND BLAST TO CLEAN, REBUILD UNIT AND COAT FOR CORROSION
4. SHIP REPIARED RADIATOR BACK AND REINSTALL RADIATOR AND ALL COMPONENTS REMOVED, REFILL RADIATOR
5. RUN GENERATOR TO OPERATING TEMPERTURES AND CHECK FOR LEAKS.

/LABOR STANDARD LABOR TECH 1	EACH	16.00	0.00	0.00	120.00	1,920.00
/LABOR STANDARD LABOR TECH 2	EACH	16.00	0.00	0.00	120.00	1,920.00
/LABOR STANDARD LABOR TECH 1 AFTER HOURS	EACH	3.00	0.00	0.00	180.00	540.00
/LABOR STANDARD LABOR TECH 2 AFTER HOURS	EACH	3.00	0.00	0.00	180.00	540.00
/TRAVEL TRAVEL	EACH	1.00	0.00	0.00	250.00	250.00

Continued

CONSENT
 AGENDA ITEM # 6

Quote



Order Number: 0151378
Order Date: 9/19/2017

Energy Systems Southeast, LLC
3235 Veterans Circle
Birmingham, AL 35235
2055202183

Salesperson: JM
Customer Number: 50-PANAMAC

Sold To:
City of Panama City Water Dept
110 South Arnold
Panama City Beach, FL 32413

Ship To:
Panama City Water Department
Reuse to Wetland System
206 North Gulf Blvd
Panama City Beach, FL 32413

Confirm To:
ANGEL AGEE

Customer P.O.	Ship VIA	F.O.B.	Terms 30 days			
Item Number	Unit	Ordered	Shipped	Back Order	Price	Amount
MOBILIZATION FOR 2 TECHS						
/CONTRACT GA		1.00	0.00	0.00	16,400.00	16,400.00
CONTRACT LABOR GA -200						
RADIATOR RECORE WITH UVE COATING APPLIED						
090283	EACH	1.00	0.00	0.00	16.77	16.77
CAP RADIATOR 13 PSI						
ANTIFREEZE	EACH	35.00	0.00	0.00	16.95	593.25
Antifreeze, 50/50 Premix						
MISC S						
Service Supplies/Disposal Fee						
SERVICE SUPPLIES/DISPOSAL ENVIROMENTAL FEES						
/FRT		1.00	0.00	0.00	2,200.00	2,200.00
FREIGHT						

Net Order: 24,630.02
Less Discount: 0.00
Freight: 0.00
Sales Tax: 0.00
Order Total: 24,630.02

CONSENT
AGENDA ITEM # 6

CONSENT AGENDA

ITEM 7



CITY OF PANAMA CITY BEACH AGENDA ITEM SUMMARY

1. DEPARTMENT MAKING REQUEST/NAME:

Utilities Department - Al Shortt, Utilities Director

2. MEETING DATE:

December 14, 2017

3. REQUESTED MOTION/ACTION:

Approve the purchase of replacement pipe and fittings for the City's wastewater treatment facility.

4. AGENDA

PRESENTATION
PUBLIC HEARING
CONSENT
REGULAR

5. IS THIS ITEM BUDGETED (IF APPLICABLE)? Yes No N/A
BUDGET AMENDMENT OR N/A

DETAILED BUDGET AMENDMENT ATTACHED Yes No N/A

6. BACKGROUND: (WHY IS THE ACTION NECESSARY, WHAT GOAL WILL BE ACHIEVED)

A previous resolution provided for the purchase of the majority of the pipe fittings and valves needed for this project at the City's Wastewater Treatment Facility. However, additional items are needed based upon finalization of the design and bid documents and subsequently noted maintenance needs as tabulated in the attachment.

A few of the items are additional units of lowest bid items from the previous solicitation or additional items similar to those from the lowest bidder.

This project is currently budgeted and the proposed expenditure is within the budgeted amount. Attached is a copy of an itemized breakdown of the needed additional items.

WHY - To purchase additional materials as follow: Jim House and Associates, Inc. (Flygt pump vendor) - \$9,275.00, Temsco - \$16,586.65, Ferguson Waterworks - \$1,299.04, Fortiline Inc. - \$1,449.93 and Lanier Municipal Supply, Inc. - \$12,150.00 or a total amount of \$40,760.62.

WHAT - To allow timely replacement of the corroded piping, maintenance of select items and make piping provisions to avoid influent pumping station by-pass pumping costs in this and future maintenance projects.

CONSENT
AGENDA ITEM # _____

7

RESOLUTION 18-31

A RESOLUTION OF THE CITY OF PANAMA CITY BEACH, FLORIDA, APPROVING THE PURCHASE OF ADDITIONAL PIPING REPLACEMENT MATERIALS FOR THE CITY'S WASTEWATER TREATMENT FACILITY FROM FIVE DIFFERENT VENDORS IN THE TOTAL AMOUNT OF \$40,760.62 AS MORE PARTICULARLY SET FORTH IN THE RESOLUTION; AND PROVIDING AN IMMEDIATELY EFFECTIVE DATE.

BE IT RESOLVED by the City Council of the City of Panama City Beach that:

1. The appropriate officers of the City are authorized but not required to accept and deliver on behalf of the City that certain Agreement between the City and Jim House and Associates, Inc. in the basic amount of Nine Thousand Two Hundred Seventy Five Dollars (\$9,275.00), relating to the purchase of piping replacement materials for the City's Wastewater Treatment Facility, with such changes, insertions or omissions as may be approved by the City Manager and whose execution shall be conclusive evidence of such approval;
2. The appropriate officers of the City are authorized but not required to accept and deliver on behalf of the City that certain Agreement between the City and Temsco in the basic amount of Sixteen Thousand Five Hundred Eighty Six Dollars and Sixty-Five Cents (\$16,586.65), relating to the purchase of piping replacement materials for the City's Wastewater Treatment Facility, with such changes, insertions or omissions as may be approved by the City Manager and whose execution shall be conclusive evidence of such approval;
3. The appropriate officers of the City are authorized but not required to accept and deliver on behalf of the City that certain Agreement between the City and Ferguson Waterworks in the basic amount of One Thousand Two Hundred Ninety Nine Dollars and Four Cents (\$1299.04), relating to the purchase of piping replacement materials for the City's Wastewater Treatment Facility, with such changes, insertions or omissions as may be approved by the City Manager and whose execution shall be conclusive evidence of such approval;

Resolution 18-31

CONSENT
AGENDA ITEM # 7

4. The appropriate officers of the City are authorized but not required to accept and deliver on behalf of the City that certain Agreement between the City and Fortiline Inc. in the amount of One Thousand Four Hundred Forty Nine Dollars and Ninety-Three Cents (\$1,449.93) relating to the purchase of piping replacement materials for the City's Wastewater Treatment Facility, with such changes, insertions or omissions as may be approved by the City Manager and whose execution shall be conclusive evidence of such approval; and
5. The appropriate officers of the City are authorized but not required to accept and deliver on behalf of the City that certain Agreement between the City and Lanier Municipal Supply, Inc. in the amount of Twelve Thousand One Hundred Fifty Dollars (\$12,150.00), relating to the purchase of influent piping replacement for the City's Wastewater Treatment Facility, with such changes, insertions or omissions as may be approved by the City Manager and whose execution shall be conclusive evidence of such approval.

THIS RESOLUTION shall be effective immediately upon passage.

PASSED in regular session this ___ day of _____, 2017.

CITY OF PANAMA CITY BEACH

By: _____
Mike Thomas, Mayor

ATTEST:

Jo Smith, City Clerk

Resolution 18-31
CONSENT
AGENDA ITEM # _____ 7

**CITY OF PANAMA CITY BEACH
 ADDITIONAL MATERIALS PURCHASE
 PANAMA CITY BEACH - WWTF INFLUENT PIPING REPLACEMENT - PIPE AND FITTINGS**

1	Base Elbow and Sliderails	EA	1	Flygt	\$7,980.00
2	Upper Sliderail Brackets	EA	5	Flygt	\$1,295.00
3	Stainless Steel Flange Packs with Bolts and Gaskets (18) 14-inch and (6) 12-inch	LS		Lanier	\$750.00
4	12x14 PExFL Concentric Reducers (SS)	EA	6	Lanier	\$11,400.00
5	14-inch Swing Check Valve	EA	1	Temsco	\$5,378.00
6	Swing Check Valve Rebuild Kits	EA	5	Temsco	\$11,208.65
7	30 x 18 inch Flanged Spool Piece	EA	1	Fortiline	\$1,449.93
8	6-inch MJ Restrainers	EA	8	Ferguson	\$301.04
9	42-inch PExPE 36-inches long Spool Pc	EA	1	Ferguson	<u>\$998.00</u>
					\$40,760.62

	<u>Subtotals</u>	
	Flygt	\$9,275.00
	Temsco	\$16,586.65
	Lanier	\$12,150.00
	Ferguson	\$1,299.04
	Fortiline	\$1,449.93

CONSENT
 AGENDA ITEM #

7

CONSENT AGENDA

ITEM 8



CITY OF PANAMA CITY BEACH AGENDA ITEM SUMMARY

1. DEPARTMENT MAKING REQUEST/NAME:

Utilities Department - Al Shortt, Utilities Director

2. MEETING DATE:

December 14, 2017

3. REQUESTED MOTION/ACTION:

Approve a Task Order with Dewberry Engineers, Inc. for engineering and inspection services related to the replacement of 15 sewer manholes located under the Thomas Drive roadway.

4. AGENDA

PRESENTATION
PUBLIC HEARING
CONSENT
REGULAR

5. IS THIS ITEM BUDGETED (IF APPLICABLE)? YES NO N/A
BUDGET AMENDMENT OR N/A

DETAILED BUDGET AMENDMENT ATTACHED YES NO N/A

6. BACKGROUND: (WHY IS THE ACTION NECESSARY, WHAT GOAL WILL BE ACHIEVED)

Bay County has notified the City that it plans to make improvements to approximately 3.1 miles of the Thomas Drive roadway. Portions of the City water and sewer utilities that could interfere with the planned County roadway improvements will need to be relocated, or replaced. Planning is underway for a more extensive utility project, but an immediate need is being separated out for action now. Several gravity sewer manholes under the roadway are 20 years old and have been seriously degraded by hydrogen sulfide gases. They will need to be replaced and the work will involve closing portions of travel lanes while the excavation work takes place.

Staff requested a proposal from Dewberry Engineers to provide the necessary engineering plans and contract documents for bidding the construction work, and inspection services during construction. Attached for your review is their proposal as Attachment A under the current Master Services Agreement for general utility services. Staff has reviewed the proposal and finds that the requested fee of \$21,350 is in line with the work effort. Construction costs are anticipated to be approximately \$275,000. Also attached for your review is a draft Exhibit B, Combined Task Order and Notice To Proceed, that the City Manager would be authorized to execute on behalf of the City upon City Council approval. Staff recommends approval of the Task Order and the project is budgeted for this fiscal year

WHY - To allow the City Manager to execute Task Order 2017-01 between the City and Dewberry Engineers for engineering services related to the Thomas Drive Manhole Replacement project.

WHAT - Completion of necessary engineering and inspection services as part of the replacement of critical City utility assets under a County roadway.

CONSENT
AGENDA ITEM # 8

RESOLUTION 18-32

A RESOLUTION OF THE CITY OF PANAMA CITY BEACH, FLORIDA APPROVING TASK ORDER #2017-01 TO THE MASTER SERVICES AGREEMENT WITH DEWBERRY ENGINEERS, INC. RELATED TO ENGINEERING AND INSPECTION SERVICES FOR THE REPLACEMENT OF 15 SEWER MANHOLES ON THOMAS DRIVE IN AN AMOUNT OF \$21,350.

BE IT RESOLVED that the appropriate officers of the City are authorized but not required to accept and deliver on behalf of the City that certain Task Order 2017-01 to the Master Services Agreement for Utility Engineering Services dated April 8, 2014 between the City and Dewberry Engineers, Inc., relating to Engineering and Inspection services for the replacement of 15 sewer manholes on Thomas Drive, in the total lump sum amount of Twenty One Thousand, Three Hundred Fifty Dollars (\$21,350), in substantially the form attached and presented to the Council today, with such changes, insertions or omissions as may be approved by the City Manager and whose execution shall be conclusive evidence of such approval.

THIS RESOLUTION shall be effective immediately upon passage.

PASSED in regular session this ___ day of _____, 2017.

CITY OF PANAMA CITY BEACH

By: _____
Mike Thomas, Mayor

ATTEST:

Jo Smith, City Clerk

Resolution 18-32

CONSENT
AGENDA ITEM # _____

8

December 5, 2017

Via Email at ashortt@pcb.gov

Attn: Al Shortt, PE, Utilities Director
City of Panama City Beach
110 South Arnold Road
Panama City Beach, Florida 32413

RE: Panama City Beach – Thomas Drive Manholes Replacement Project (Joan Avenue to Choctaw Street)

Dear Mr. Shortt:

Dewberry Engineers Inc. (Dewberry) is pleased to submit this task order for providing the engineering services required in conjunction with the replacement of fifteen (15) sanitary sewer manholes along Thomas Drive from Joan Avenue to Choctaw Street. As discussed during our meeting on November 29, 2017, these manholes have deteriorated to the point that repairs will not extend the life of the structure and as a result, total replacement will be required. It is also our understanding that Thomas Drive will be resurfaced prior to the summer season and that manhole replacement will only need to include patching pavement around each manhole to match existing.

Dewberry will provide professional engineering services to replace these manholes using topographic survey information provided by Bay County, performed by Southeastern Surveying and Mapping Corporation in September 2017. However, a cursory review of the survey data, revealed that existing manholes at the intersection of Utes and Choctaw streets with Thomas Drive, were not surveyed because they are currently paved over. As a result, they will need to be exposed by others so that we can obtain accurate horizontal and vertical information for all sanitary sewer pipes entering and exiting each manhole.

Based on the information referenced above, Dewberry will provide design, Bay County coordination, bid document preparation and limited construction administration including periodic site visits to the City of Panama City Beach for a lump sum fee of **\$21,350.00**. Please see the attached **Task Order 2017.01** defining the scope of services (**Attachment A**). If you have any questions, please give me a call at 850.571.1158. We look forward to working with the City on this project and thank you for the opportunity to be of continued service.

Sincerely,

Dewberry Engineers Inc.



Jose A. Pereira, PE
Senior Associate

Attachments: Attachment A (Task Order – Scope of Services)

cc: Mr. Clifford Wilson III, PE, Vice-President, Dewberry (via email cwilson@dewberry.com)
Mr. Eric Pitts, Senior Project Manager, Dewberry (via email epitts@dewberry.com)
Mr. Jon Sklarski, PE, Senior Associate, Dewberry (via email jklarski@dewberry.com)
Mrs. Missy Ramsey, CPA, Controller, Dewberry (via email mramsey@dewberry.com)

K:\PROPOSALS\Thomas Drive Manholes Replacement 12 05-17 docx

**Attachment A
Scope of Services, Task Order 2017-01
CITY OF PANAMA CITY BEACH**

Thomas Drive Manholes Replacement Project (Joan Avenue to Choctaw Street)

This task order is for the purpose of Dewberry Engineers Inc. (Dewberry), as the ENGINEER, to provide professional engineering services in conjunction with the replacement of fifteen (15) sanitary sewer manholes along Thomas Drive from Joan Avenue to Choctaw Street for the City of Panama City Beach (City) acting by and through its Council under the **MASTER SERVICES AGREEMENT BETWEEN CITY OF PANAMA CITY BEACH AND DEWBERRY ENGINEERS INC. (formerly PREBLE-RISH, INC.) RELATING TO UTILITY ENGINEERING SERVICES (General Water and Sewer and Reclaimed Utility) dated April 8, 2014.**

DESCRIPTION OF ENGINEER'S SERVICES

SCOPE OF SERVICES

A. Professional Services

Dewberry will coordinate with Bay County and/or its consultant(s) to obtain the survey information along the proposed project along Thomas Drive, between Joan Avenue and Choctaw Street. Consulting with City staff, Dewberry will use this information to prepare construction drawings and bid documents for the replacement of the existing 15 sanitary sewer manholes. In addition, Dewberry will coordinate all necessary permitting (as needed) and/or notification efforts with the applicable agencies.

A cursory review of the survey performed to Bay County, has revealed that two of the existing 15 manholes that are proposed to be replaced, were not surveyed, since they are currently below the pavement. The two manholes are located at the intersection of Utes and Choctaw Streets with Thomas Drive. The rim of the two manholes will need to be excavated and exposed in order for Dewberry to obtain vertical elevations of the sewer pipes. As a result, this scope of services only includes surveying efforts for locating horizontally and vertical the two subject manholes. Our intent is to obtain and use the survey data from Bay County and the plans that show all existing utilities within the right-of-way.

B. Deliverables

Dewberry will provide the following deliverables to the City:

1. Construction plans
2. Bid documents.
3. All necessary coordination with City and Bay County.
4. Limited construction administration services to include shop drawings review and approval and periodic site visits (72 hours, Not to exceed 4 hours per day) to ensure the project is being constructed in conformance with plans and specifications.

C. Professional Services Fees

1. Surveying (two manholes and control points verification from previous survey)	\$950.00
2. Engineering and preparation of Contract Documents	\$11,280.00
3. Bidding/Construction Administration/Periodic Inspection	<u>\$9,120.00</u>
Lump Sum Total	\$21,350.00

IN WITNESS WHEREOF, the parties hereto have caused this Task Order to be executed by their undersigned officials as duly authorized.

DEWBERRY

203 Aberdeen Parkway
Panama City, Florida 32408

By: _____

Name and Title: Jose A. Pereira, PE.
Senior Associate

Witnessed: _____

Date: 12/06/2017

CITY OF PANAMA CITY BEACH, FLORIDA

110 South Arnold Road
Panama City Beach, Florida 32413

By: _____

Name and Title: Mr. Mario Gisbert
City Manager

Witnessed: _____

Date: _____

K:\PROPOSALS\Thomas Drive\Design Services Attachment A 12-5-17.doc

CONSENT
ORDINANCE ITEM # _____

8

EXHIBIT B
COMBINED TASK ORDER AND
NOTICE TO PROCEED

TASK ORDER NO. 2017-01

DATE : December __, 2017

Reference is made to that certain MASTER SERVICES AGREEMENT BETWEEN CITY OF PANAMA CITY BEACH AND DEWBERRY ENGINEERS INC. (formerly PREBLE-RISH INC.) RELATING TO UTILITY ENGINEERING SERVICES (General Water and Sewer and Reclaimed Utility) dated April 8, 2014, (the Agreement), the terms, conditions and definitions of which are incorporated herein as if set forth in full. Neither party is in breach of the Agreement.

Pursuant to the Agreement, Engineer agrees to perform the specific tasks set forth upon incorporated Attachment A, Scope of Services, relating to **Thomas Drive Manholes Replacement Project**.

Engineer's total compensation shall be (check one):

- a stipulated sum of **\$21,350**; or
 a stipulated sum of \$ _____ plus one or more specified allowances listed below which may be authorized in writing by the City Manager or his designee,
Allowance of \$ _____ for _____, and
Allowance of \$ _____ for _____; or
 a fee determined on a time-involved basis with a maximum cost of \$ _____;

Work shall begin on December 15, 2017, and shall be completed within 120 days. The date of completion of all work is therefore April 14, 2018. Liquidated delay damages, if any, are set at the rate of \$0 per day. There are no additional rights and obligations related to this Task Order other than as specified in the Agreement.

Upon execution of this task order by both Engineer and City, Engineer is directed to proceed.

IN WITNESS WHEREOF the parties have caused these presents to be executed in their names on the date shown.

Witness:

DEWBERRY ENGINEERS, INC.

By: _____ Date: _____
Its:

ATTEST:

CITY OF PANAMA CITY BEACH, FLA.

City Clerk

By: _____ Date: _____
City Manager

CONSENT
AGENDA ITEM #

8

CONSENT AGENDA
ITEM 9



CITY OF PANAMA CITY BEACH AGENDA ITEM SUMMARY

1. DEPARTMENT MAKING REQUEST/NAME:

Utilities Department - Al Shortt, Utilities Director

2. MEETING DATE:

December 14, 2017

3. REQUESTED MOTION/ACTION:

Approve the construction Agreement with Talcon Group, LLC for the replacement of existing piping that has reached the end of its service life at the City's Wastewater Treatment Facility.

4. AGENDA

PRESENTATION
PUBLIC HEARING
CONSENT
REGULAR

5. IS THIS ITEM BUDGETED (IF APPLICABLE)? YES NO N/A
BUDGET AMENDMENT OR N/A

DETAILED BUDGET AMENDMENT ATTACHED YES NO N/A

6. BACKGROUND: (WHY IS THE ACTION NECESSARY, WHAT GOAL WILL BE ACHIEVED)

Sections of the existing piping at the City's Wastewater Treatment Facility (WWTF) are exhibiting advanced corrosion and require replacement to maintain required service condition. In addition, a by-pass piping segment is needed so staff can isolate the influent pumping station for maintenance purposes to avoid future by-pass pumping costs when performing maintenance on the influent pumping station.

Preparation of the bid documents for the installation of replacement piping and fittings along with other minor maintenance items was performed by City Utility Department staff. A solicitation of construction bids was publicly advertised and two bids received. The bid documents included alternate bid provisions for rebuilding the existing check valves and replacement of up to two pump riser assemblies should de-watering of the wetwell find it is required. Staff recommends award of the Base Bid plus Alternates to Talcon Group, LLC in the amount of \$417,010.00.

This project is currently budgeted and the wastewater budget has sufficient funds in this current fiscal year to proceed. Attached is a copy of the Bid Tabulation and proposed Agreement for consideration.

WHY - To allow the City Manager to enter into a construction contract with Talcon for the specified work in the total amount of \$417,010.00

WHAT - To allow timely replacement of the corroded piping and make piping provisions to avoid influent pumping station by-pass pumping costs in this and future maintenance projects.

CONSENT
AGENDA ITEM #

9

RESOLUTION 18-33

A RESOLUTION OF THE CITY OF PANAMA CITY BEACH, FLORIDA, APPROVING AN AGREEMENT WITH TALCON GROUP, LLC IN THE TOTAL AMOUNT OF \$417,010 FOR THE INSTALLATION OF REPLACEMENT PIPING AND FITTINGS AT THE CITY'S WASTEWATER TREATMENT FACILITY; AND PROVIDING AN IMMEDIATELY EFFECTIVE DATE.

BE IT RESOLVED that the appropriate officers of the City are authorized but not required to accept and deliver on behalf of the City that certain Agreement between the City and Talcon Group, LLC in the total amount of Four Hundred Seventeen Thousand Ten Dollars (\$417,010), relating to the installation of replacement piping and fittings at the City's Wastewater Treatment Facility, in substantially the form attached and presented to the Council today, with such changes, insertions or omissions as may be approved by the City Manager and whose execution shall be conclusive evidence of such approval.

THIS RESOLUTION shall be effective immediately upon passage.

PASSED in regular session this ___ day of _____, 2017.

CITY OF PANAMA CITY BEACH

By: _____
Mike Thomas, Mayor

ATTEST:

Jo Smith, City Clerk

Resolution 18-33

CONSENT
AGENDA ITEM # _____

9

**BID TABULATION FOR
WWTF INFLUENT PIPING REPLACEMENT
CITY OF PANAMA CITY BEACH**

Bid Date: December 5, 2017

				Talcon Group, LLC 156 Dupont Road, Havana, FL 32333		Marshall Brothers Construction and Engineering, Inc. 2305 Transmitter Road, Panama City, FL 32404	
Item No.	Description	Unit	Quantity	Unit Price	Cost	Unit Price	Cost
BASE BID							
GENERAL							
1	Mobilization/Demobilization (Not to exceed 3% of the total base bid)	LS			\$ 12,000.00		\$ 13,400.00
2	Bonds and Insurance (not to exceed 2% of the total base bid)	LS			\$ 8,000.00		\$ 8,900.00
3	Testing Allowance	Allowance			\$ 1,000.00		\$ 1,000.00
4	Hold Harmless	LS			\$ 10.00		\$ 10.00
5	Remove and Replace Existing Yard Piping	LS			\$ 220,000.00		\$ 207,800.00
6	Remove Existing Grit and Debris Accumulations in Influent Pumping Station						
	A. Grit	CY	100	\$ 50.00	\$ 5,000.00	\$ 249.00	\$ 24,900.00
	B. Debris	CY	100	\$ 50.00	\$ 5,000.00	\$ 173.00	\$ 17,300.00
7	Remove and Replace Influent Pumping Station Riser Piping and All Other Improvements	LS			\$ 135,000.00		\$ 127,800.00
8	Remove and Dispose of Surplus Hypochlorite Tanks	LS			\$ 8,000.00		\$ 3,600.00
9	Construct All Other Improvements for Influent Piping and Pumping Station Piping Replacement	LS			\$ 10,000.00		\$ 43,350.00
TOTAL BASE BID					\$ 404,010.00		\$ 448,060.00
ALTERNATE BID							
GENERAL							
Item No.	Description	Unit	Quantity	Unit Price	Cost	Unit Price	Cost
1	Remove Existing Spool Piece from Influent Pump 5 Discharge and Install Check Valve	LS			\$ 4,000.00		\$ 4,500.00
2	Remove Existing Influent Pump Base Elbow and Install Replacement Base Elbow	EA	2	\$ 4,500.00	\$ 9,000.00	\$ 8,900.00	\$ 17,800.00
TOTAL ALTERNATE BID					\$ 13,000.00		\$ 22,300.00

CONSENT
AGENDA ITEM #

9

PANAMA CITY BEACH – WWTF INFLUENT PIPING REPLACEMENT

SECTION 00050

AGREEMENT

THIS AGREEMENT is made this _____ day of _____, 201__ by and between THE CITY OF PANAMA CITY BEACH, FLORIDA, (hereinafter called "OWNER") and Talcon Group, LLC, doing business as a corporation (an individual), or (a partnership), or (a corporation), having a business address of 156 Dupont Road, Havana, FL 32333 (hereinafter called "CONTRACTOR"), for the performance of the Work (as that terms is defined below) in connection with the construction of **WWTF INFLUENT PIPING REPLACEMENT** ("Project"), to be located at the City of Panama City Beach, Florida, in accordance with the Drawings and Specifications prepared by the City of Panama City Beach, the Engineer of Record (hereinafter called "Engineer") and all other Contract Documents hereafter specified.

OWNER and CONTRACTOR, for the consideration herein set forth, agree as follows:

1. The CONTRACTOR shall furnish, at its sole expense, all supervision, labor, equipment, tools, material, and supplies to properly and efficiently perform all of the work required under the Contract Documents and shall be solely responsible for the payment of all taxes, permits and license fees, labor fringe benefits, insurance and bond premiums, and all other expenses and costs required to complete such work in accordance with this Agreement (collectively the "Work"). CONTRACTOR'S employees and personnel shall be qualified and experienced to perform the portions of the Work to which they have been assigned. In performing the Work hereunder, CONTRACTOR shall be an independent contractor, maintaining control over and having sole responsibility for CONTRACTOR'S employees and other personnel. Neither CONTRACTOR, nor any of CONTRACTOR'S sub-contractors or sub-subcontractors, if any, nor any of their respective

AGREEMENT

00050-1

CONSENT
AGENDA ITEM #

9

PANAMA CITY BEACH – WWTF INFLUENT PIPING REPLACEMENT

employees or personnel, shall be deemed servants, employees, or agents of OWNER.

- The CONTRACTOR will commence the Work required by the Contract Documents within ten (10) calendar days after the date of the NOTICE TO PROCEED to be issued by OWNER in writing within thirty (30) calendar days from the date of this Agreement and will achieve Substantial Completion of the Work within of the required commencement date as follows, except to the extent the period for Substantial Completion is extended pursuant to the terms of the Contract Documents ("Contract Time"):

<u>Completion Milestone</u>	<u>Calendar Days Following Notice to Proceed</u>
Complete By-pass Piping from Screening Structure to Influent Pumping Station	30
Complete All Influent Pumping Station Improvements	60
Complete Piping Removal and Replacement from Grit Units to Influent Pumping Station	90

Final Completion of the Work shall be achieved by CONTRACTOR within the time period set forth in Section 15.2 of Section 00100, General Conditions.

- The CONTRACTOR agrees to pay the OWNER, as liquidated damages, the sum of \$500 for each calendar day that expires after the Contract Time for Substantial Completion as more fully set forth in Section 15 of the General

AGREEMENT

00050-2

CONSENT
AGENDA ITEM # _____

9

PANAMA CITY BEACH – WWTF INFLUENT PIPING REPLACEMENT

Conditions.

4. The CONTRACTOR agrees to perform all of the Work described in the Contract Documents and comply with the terms therein for the sum of \$ 417,010.00 as shown in the BID SCHEDULE, included within the Bid Proposal Form, as said amount may be hereafter adjusted pursuant to the terms of the Contract Documents ("Contract Price").

5. The term "Contract Documents" means and includes the following documents, all of which are incorporated into this Agreement by this reference:

Section 00010	ADVERTISEMENT FOR BIDS
Section 00020	INFORMATION FOR BIDDERS
Section 00030	BID PROPOSAL FORM
Section 00040	BID BOND
Section 00050	AGREEMENT
Section 00060	PERFORMANCE BOND
Section 00070	PAYMENT BOND
Section 00080	NOTICE OF AWARD
Section 00090	NOTICE TO PROCEED
Section 00095	STATEMENT UNDER SECTION 287.087, FLORIDA STATUTES, ON PREFERENCE TO BUSINESSES WITH DRUG-FREE WORKPLACE PROGRAMS
Section 00096	TRENCH SAFETY ACT CERTIFICATE OF COMPLIANCE
Section 00097	PUBLIC ENTITY CRIMES STATEMENT
Section 00099	CERTIFICATE OF INSURANCE
Section 00100	GENERAL CONDITIONS
Section 00800	SUPPLEMENTAL CONDITIONS

AGREEMENT

00050-3

CONSENT
AGENDA ITEM # 9

PANAMA CITY BEACH – WWTF INFLUENT PIPING REPLACEMENT

DRAWINGS prepared by the City of Panama City Beach Numbered G-000 through M-902 and dated October 2017.

SPECIFICATIONS prepared or issued by the City of Panama City Beach Dated October 2017.

ADDENDA

No. 1 , dated November 28, 2017

No. 2 , dated December 1, 2017

No. , dated , 20

No. , dated , 20

The Contract Documents also includes any written amendments to any of the above signed by the party to be bound by such amendment. The Contract Documents are sometimes referred to herein as the "Agreement".

6. The OWNER will pay the Contract Price to the CONTRACTOR in the manner and at such times as set forth in Contract Documents.
7. This Agreement shall be binding upon all parties hereto and their respective heirs, executors, administrators, successors, and assigns.
8. This Agreement shall be governed by the laws of the State of Florida.
9. All notices required or made pursuant to this Agreement shall be in writing and, unless otherwise required by the express terms of this Agreement, may be given either (i) by mailing same by United States mail with proper postage affixed thereto, certified, return receipt requested, or (ii) by sending same by Federal Express, Express Mail, UPS, DHL, Purolator or other expedited mail or package delivery, or (iii) by hand delivery to the appropriate address as herein provided. Notices to OWNER required hereunder shall be directed to the following address:

If to Owner:

City of Panama City Beach

110 South Arnold Road

Panama City Beach, FL 32413
ATTENTION: _____ Mario Gisbert, City Manager

AGREEMENT

00050-4

CONSENT
AGENDA ITEM # _____



PANAMA CITY BEACH – WWTF INFLUENT PIPING REPLACEMENT

Fax No.: _____ (850) 233-5108 _____

If to Contractor:

Talcon Group, LLC
156 Dupont Road, Havana, FL 32333
ATTENTION: Mr. Rick D. Neisus - Manager
Fax No.: _____ (850)574-4400 _____

Either party may change its above noted address by giving written notice to the other party in accordance with the requirements of this Section.

10. CONTRACTOR recognizes that OWNER is exempt from sales tax and may wish to generate sales tax savings for the Project. Accordingly, to the extent directed by and without additional charge to OWNER, CONTRACTOR shall comply with and fully implement the sales tax savings program as more fully described in the Sales Tax Exemption Addendum. If required by OWNER, the Sales Tax Exemption Addendum shall be made a part of the Contract Documents, the form of which is set forth in Section 00808.
11. The failure of OWNER to enforce at any time or for any period of time any one or more of the provisions of the Agreement shall not be construed to be and shall not be a continuing waiver of any such provision or provisions or of its right thereafter to enforce each and every such provision.
12. Each of the parties hereto agrees and represents that the Agreement comprises the full and entire agreement between the parties affecting the Work contemplated, and no other agreement or understanding of any nature concerning the same has been entered into or will be recognized, and that all negotiations, acts, work performed, or payments made prior to the execution hereof shall be deemed merged in, integrated and superseded by this Agreement.
13. Should any provision of the Agreement be determined by a court with

AGREEMENT

00050-5

CONSENT
AGENDA ITEM # _____

9

jurisdiction to be unenforceable, such a determination shall not affect the validity or enforceability of any other section or part thereof.

14. Unless the context of this Agreement otherwise clearly requires, references to the plural include the singular, references to the singular include the plural. The term "including" is not limiting, and the terms "hereof", "herein", "hereunder", and similar terms in this Agreement refer to this Agreement as a whole and not to any particular provision of this Agreement, unless stated otherwise. Additionally, the parties hereto acknowledge that they have carefully reviewed this Agreement and have been advised by counsel of their choosing with respect thereto, and that they understand its contents and agree that this Agreement shall not be construed more strongly against any party hereto, regardless of who is responsible for its preparation.

15. For this Project, OWNER has designated a Project Representative to assist OWNER with respect to the administration of this Agreement. The Project Representative to be utilized by OWNER for this Project, shall be Mr. Mark Shaeffer, P.E. – Utilities Engineer.

16. CONTRACTOR acknowledges and agrees that no interruption, interference, inefficiency, suspension or delay in the commencement or progress of the Work from any cause whatever, including those for which the OWNER, PROJECT REPRESENTATIVE, or ENGINEER may be responsible, in whole or in part, shall relieve CONTRACTOR of its duty to perform or give rise to any right to damages or additional compensation from OWNER. CONTRACTOR expressly acknowledges and agrees that it shall receive no damages for delay. CONTRACTOR's sole remedy, if any, against OWNER will be the right to seek an extension to the Contract Time; provided, however, the granting of any such time extension shall not be a condition

AGREEMENT

00050-6

CONSENT
AGENDA ITEM # _____



precedent to the aforementioned "No Damage For Delay" provision. This section shall expressly apply to claims for early completion, as well as to claims based on late completion. Notwithstanding the foregoing, if the Work is delayed due to the fault or neglect of OWNER or anyone for whom OWNER is liable, and such delays have a cumulative total of more than 90 calendar days. Except as expressly set forth in this Section, in no event shall OWNER be liable to CONTRACTOR whether in contract, warranty, tort (including negligence or strict liability) or otherwise for any acceleration, soft costs, lost profits, special, indirect, incidental, or consequential damages of any kind or nature whatsoever.

17. INSURANCE - BASIC COVERAGES REQUIRED

The CONTRACTOR shall procure and maintain the following described insurance on policies and with insurers acceptable to OWNER. Current Insurance Service Office (ISO) policies, forms, and endorsements or equivalents, or broader, shall be used where applicable.

These insurance requirements shall not limit the liability of the CONTRACTOR. The insurance coverages and limits required of CONTRACTOR under this Agreement are designed to meet the minimum requirements of OWNER and the OWNER does not represent these types or amounts of insurance to be sufficient or adequate to protect the CONTRACTOR'S interests or liabilities. CONTRACTOR alone shall be responsible to the sufficiency of its own insurance program.

The CONTRACTOR and the CONTRACTOR'S subcontractors and sub-subcontractors shall be solely responsible for all of their property, including but not limited to any materials, temporary facilities, equipment and vehicles, and for obtaining adequate and appropriate insurance covering any damage

AGREEMENT

00050-7

CONSENT
AGENDA ITEM # _____



or loss to such property. The CONTRACTOR and the CONTRACTOR'S sub-contractors and sub-subcontractors expressly waive any claim against OWNER arising out of or relating to any damage or loss of such property, even if such damage or loss is due to the fault or neglect of the OWNER or anyone for whom the OWNER is responsible. The CONTRACTOR is obligated to include, or cause to be included, provisions similar to this paragraph in all of the CONTRACTOR'S subcontracts and its subcontractors' contracts with their sub-subcontractors.

The CONTRACTOR'S deductibles/self-insured retention's shall be disclosed to OWNER and are subject to OWNER'S approval. They may be reduced or eliminated at the option of OWNER. The CONTRACTOR is responsible for the amount of any deductible or self-insured retention. Any deductible or retention applicable to any claim or loss shall be the responsibility of CONTRACTOR and shall not be greater than \$25,000, unless otherwise agreed to, in writing, by OWNER.

Insurance required of the CONTRACTOR or any other insurance of the CONTRACTOR shall be considered primary, and insurance of OWNER shall be considered excess, as may be applicable to claims or losses which arise out of the Hold Harmless, Payment on Behalf of OWNER, Insurance, Certificates of Insurance and any Additional Insurance provisions of this agreement, contract or lease.

WORKERS' COMPENSATION AND EMPLOYERS' LIABILITY INSURANCE
COVERAGE

The CONTRACTOR shall purchase and maintain workers' compensation and employers' liability insurance for all employees engaged in the Work, in

AGREEMENT

00050-8

CONSENT
AGENDA ITEM # _____



PANAMA CITY BEACH – WWTF INFLUENT PIPING REPLACEMENT

accordance with the laws of the State of Florida, and, if applicable to the Work, shall purchase and maintain Federal Longshoremen's and Harbor Workers' Compensation Act Coverage. Limits of coverage shall not be less than:

\$1,000,000	Limit Each Accident
\$1,000,000	Limit Disease Aggregate
\$1,000,000	Limit Disease Each Employee

The CONTRACTOR shall also purchase any other coverage required by law for the benefit of employees.

The CONTRACTOR shall provide to OWNER an Affidavit stating that it meets all the requirements of Florida Statute 440.02 (15) (d).

COMMERCIAL GENERAL LIABILITY COVERAGE

CONTRACTOR shall purchase and maintain Commercial General Liability Insurance on a full occurrence form. Coverage shall include, but not be limited to, Premises and Operations, Personal Injury, Contractual for this Agreement, Independent Contractors, Broad Form Property Damage, Products and Completed Operation Liability Coverages and shall not exclude coverage for the "X" (Explosion), "C" (Collapse) and "U" (Underground) Property Damage Liability exposures. Limits of coverage shall not be less than:

AGREEMENT

00050-9

CONSENT
AGENDA ITEM # _____



PANAMA CITY BEACH – WWTF INFLUENT PIPING REPLACEMENT

Bodily Injury, Property Damage & Personal Injury	\$1,000,000 Combined Single Limit Each Occurrence, and
Liability	\$2,000,000 Aggregate Limit

The General Aggregate Limit shall be specifically applicable to this Project. The Completed Operations Liability Coverages must be maintained for a period of not less than three (3) years following OWNER'S final acceptance of the project.

The CONTRACTOR shall add OWNER as an additional insured through the use of Insurance Service Office Endorsements No. CG 20.10.10.01 and No. CG 20.37.10.01 wording or equivalent, or broader, an executed copy of which shall be attached to or incorporated by reference on the Certificate of Insurance to be provided by CONTRACTOR pursuant to the requirements of the Contract Documents.

BUSINESS AUTOMOBILE LIABILITY COVERAGE

The CONTRACTOR shall purchase and maintain Business Automobile Liability Insurance as to ownership, maintenance, use, loading and unloading of all of CONTRACTOR'S owned, non-owned, leased, rented or hired vehicles with limits not less than:

Bodily Injury & Property Damage	\$1,000,000 Combined Single Limit Each Accident
------------------------------------	--

AGREEMENT

00050-10

CONSENT
AGENDA ITEM # _____



EXCESS OR UMBRELLA LIABILITY COVERAGE

CONTRACTOR shall purchase and maintain Excess Umbrella Liability Insurance or Excess Liability Insurance on a full occurrence form providing the same continuous coverages as required for the underlying Commercial General, Business Automobile and Employers' Liability Coverages with no gaps in continuity of coverages or limits with OWNER added by endorsement to the policy as an additional insured in the same manner as is required under the primary policies, and shall not be less than \$10,000,000, each occurrence and aggregate as required by OWNER.

ADDITIONAL INSURANCE

The OWNER requires the following additional types of insurance.
[no additional insurance is required at this time]

[REMAINDER OF PAGE INTENTIONALLY LEFT BLANK]

AGREEMENT

00050-11
CONSENT
AGENDA ITEM # 9

PANAMA CITY BEACH – WWTF INFLUENT PIPING REPLACEMENT

IN WITNESS WHEREOF, the parties hereto have executed or caused to be executed by their duly authorized officials, this Agreement in two (2) copies each of which shall be deemed an original on the date first written above.

(SEAL)

OWNER:

CITY OF PANAMA CITY BEACH,
FLORIDA

ATTEST:

BY:

City Clerk

NAME: _____
(Please type)

TITLE: _____

City Attorney (as to form only)

CONTRACTOR:

TALCON GROUP, LLC

ATTEST:

BY:

NAME _____
(Please Type)

NAME: _____
(Please Type)

ADDRESS: 156 Dupont Road,
Havana, FL 32333

[END OF SECTION 00050]

AGREEMENT

00050-12

CONSENT
AGENDA ITEM # 9

REGULAR AGENDA

ITEM 1



CITY OF PANAMA CITY BEACH AGENDA ITEM SUMMARY

1. DEPARTMENT MAKING REQUEST/NAME:

Building and Planning Department/Mel Leonard

2. MEETING DATE:

12/14/2017

3. REQUESTED MOTION/ACTION:

It is requested that the City Council consider second reading and adoption of Ord 1442, the annual update to the Capital Improvements Schedule of the Comprehensive Plan.

4. AGENDA

PRESENTATION
PUBLIC HEARING
CONSENT
REGULAR

5. IS THIS ITEM BUDGETED (IF APPLICABLE)? YES NO
BUDGET AMENDMENT OR N/A

N/A

DETAILED BUDGET AMENDMENT ATTACHED YES NO

N/A

6. BACKGROUND: (WHY IS THE ACTION NECESSARY, WHAT GOAL WILL BE ACHIEVED)

On November 9, 2017, the Council approved the first reading of the annual update to the City's Capital Improvements Schedule, Ord 1442. The Capital Improvements Schedule is required to show only those projects necessary to maintain the adopted levels of service established in the City's Comprehensive Plan. The annual update is required by Section 163.3177(3)(b), Florida Statutes.

This Public Hearing was properly advertised on November 28, 2017.

ORDINANCE NO. 1442

AN ORDINANCE AMENDING ORDINANCE 1143, KNOWN AS THE 2009 AMENDED AND RESTATED CITY OF PANAMA CITY BEACH COMPREHENSIVE GROWTH DEVELOPMENT PLAN; AMENDING THE CAPITAL IMPROVEMENT ELEMENT TO UPDATE THE SCHEDULE OF CAPITAL IMPROVEMENTS; REPEALING ALL ORDINANCES IN CONFLICT HEREWITH; AND PROVIDING THAT THIS ORDINANCE SHALL TAKE EFFECT AS PROVIDED BY LAW.

WHEREAS, the Panama City Beach Council adopted the 2009 Amended and Restated City of Panama City Beach Comprehensive Growth and Development Plan (the Comprehensive Plan) on December 10, 2009, by Ordinance No. 1143; and

WHEREAS, the City has prepared the annual update to the Capital Improvement schedule, and desires to amend the Capital Improvement Element of said Comprehensive Plan by ordinance to comply with the provisions of Section 163.3177(3)(b), Florida Statutes; and

WHEREAS, the Panama City Beach Planning Board reviewed the amendment request, conducted a public hearing on October 10, 2017, and recommended approval; and

WHEREAS, on December 14, 2017, the City Council conducted a properly noticed hearing to consider the schedule of Capital Improvements, and adopted this Ordinance during that hearing.

Ordinance No.1442
Page 1 of 3

AGENDA ITEM # 1

NOW, THEREFORE, BE IT ENACTED BY THE PEOPLE OF THE CITY OF PANAMA CITY BEACH, FLORIDA:

SECTION 1. The attached Capital Improvements Schedule for planning improvements within the years 2017 through 2022 is hereby adopted.

SEE ATTACHED COMPOSITE EXHIBIT A SETTING FORTH THE UPDATED CAPITAL IMPROVEMENTS SCHEDULE

SECTION 2. All ordinances or parts of ordinances in conflict herewith are repealed to the extent of such conflict.

SECTION 3. This ordinance shall take effect as provided by law.

PASSED, APPROVED AND ADOPTED at the regular meeting of the City Council of the City of Panama City Beach, Florida, this ____ of _____, 2017.

Mike Thomas, Mayor

ATTEST:

Jo Smith, City Clerk

Ordinance No.1442
Page 2 of 3

AGENDA ITEM # 1

PUBLISHED in the Panama City News Herald on the _____ day of _____, 2017.

POSTED AT www.pcbgov.com on _____

Jo Smith, City Clerk

Ordinance No.1442
Page 3 of 3

AGENDA ITEM # 1

CAPITAL IMPROVEMENTS SCHEDULE

City of Panama City Beach FY 17/18

Traffic Circulation		Funding Source	Current Status	FY 17-18	FY 18-19	FY 19-20	FY 20-21	Beyond 21-22
1.	Clarence Av. Road Widening with sidewalks. Improve various street surfaces and shoulders	Gas Tax	on-going		\$500,000			
2.	Alf Coleman Road -4 lane widening -ped/bic. improvements -landscaping -streetscaping (needed to meet future demand)	FBR-CRA	\$26,000,000 total cost \$7,400,000 spent to date					
3.	N. Thomas Drive -4 lane widening -ped/bic. improvements -landscaping -streetscaping (needed to meet future demand)	FBR-CRA	\$990,000 spent to date \$31,000,000 total cost					
4.	Hill Road -4 lane widening -ped/bic. improvements -landscaping -streetscaping (needed to meet future demand)	FBR-CRA	\$160,900 spent to date \$16,500,000 total cost					
5.	Powell Adams Road -4 lane widening -ped/bic. improvements -landscaping -streetscaping (needed to meet future demand)	FBR-CRA Prop. Share	Seg. I Completed \$3,000,000 \$6,000,000 total cost for Seg. II					

Exhibit A
AGENDA ITEM # 1

Traffic Circulation		Funding Source	Current Status	FY 17-18	FY 18-18	FY 18-20	FY 20-21	Beyond 21-22
6.	S. Thomas Drive -public transit system -ped/bic. improvements -landscaping -streetscaping (needed to meet future demand)	FBR-CRA	Construction 56% completed in '13 \$14,230,000 total cost					
7.	Clara Avenue -4 lane widening -ped/bic. improvements -landscaping -streetscaping (needed to meet future demand)	FBR-CRA	\$124,000 spent to date \$22,000,000 total cost					
8.	Front Beach Road Segment 1 (S. Thomas to N. Thomas Drive) -public transit system -ped/bic. improvements -landscaping -streetscaping (needed to meet future demand)	FBR-CRA Part of South Thomas Dr. project. See project #7.	Construction completed in '13 \$11,130,000 total cost					
9.	Front Beach Road Segment 2 (Jackson Blvd. to S. Thomas) -public transit system -ped/bic. improvements -landscaping -streetscaping (needed to meet future demand)	FBR-CRA	Spent to date \$6,300,000	Construction CEI and Utilities \$4,550,000	\$9,800,000			

Traffic Circulation		Funding Source	Current Status	FY-17-18	FY-18-19	FY-19-20	FY-20-21	Beyond 21-22
10	Front Beach Road Segment 3 (State Road 79 to Lullwater Dr) -public transit system -ped/bic. improvements -landscaping -streetscaping (needed to meet future demand)	FBR-CRA FDOT Prop. Share	Design Const. and Util. CE&I and Post Design \$630,000 Spent to date. \$14,000,000 total cost	\$4,975,000	\$2,675,000			\$9,000,000
11	S. Arnold Road (SR 79) -4 lane widening -ped/bic. improvements -landscaping -streetscaping (needed to meet future demand)	FBR-CRA TRIP funding FDOT FDOT 5-Year Work Program	TRIP funding granted for PDE \$1,185,013 spent to date \$15,000,000 total cost	\$1,000,000				\$9,000,000
12	Front Beach Road Segment 4.1 (Lullwater Dr. to Hill Rd.) -public transit system -ped/bic. improvements -landscaping -streetscaping (needed to meet future demand)	FBR-CRA	Design Right of Way. construct.	\$753,000 \$753,000 State	\$1,616,000			\$325,000
13	Front Beach Road Segment 4.2 (Hill Rd. to Hutchison Blvd.) -public transit system -ped/bic. improvements -landscaping -streetscaping (needed to meet future demand)	FBR-CRA	Design Right of Way. construct					\$1,000,000

Traffic Circulation		Funding Source	Current Status	FY 17-18	FY 18-19	FY 19-20	FY 20-21	Beyond 21-22
14.	Front Beach Road Segment 4.3 (Hutchison Blvd. to R Jackson) -public transit system -ped/bic. improvements -landscaping -streetscaping (needed to meet future demand)	FBR-CRA	Design Right of Way, construct.					\$1,000,000
15.	Cobb Road -ped/bic. improvements -landscaping -streetscaping	FBR-CRA	No activity to date \$13,000,000 total cost					
16.	Nautilus Street -landscaping -streetscaping	FBR-CRA	\$15,000,000 total cost					
17.	North Thomas Drive Parking Lot	FBR-CRA Prop. Share	\$5,250,000 spent Parking lot stabilized					
18.	Multimodal Center West	FBR-CRA						
19.	Power Line Road (Parkway Bypass, Back Back Beach Rd.) -US 98 to SR 79, Loop Road -SR 79 to Colony Club	TBD	\$7,200,000 \$3,600,000 \$800,000					
20.	Hutchison Blvd. @ Clara	FDOT 5-Year Work Program	Traffic Signal	\$8,211	\$776,897			
21.	PCB Parkway (Mandy Lane to Thomas Dr.)	FDOT 5-Year Work Program	Preliminary Design PD&E Study	\$5,311				Ongoing
22.	ITS Improvements	FDOT 5-Year Work Program		\$450,000	\$450,000	\$450,000	\$450,000	\$500,000
23.	SR 79 from PCB Parkway to Front Beach Road	FDOT 5-Year Work Program	Right of Way Future Capacity	\$1,000,775				Ongoing

Traffic Circulation		Funding Source	Current Status	FY 17-18	FY 18-19	FY 19-20	FY 20-21	Beyond 21-22
24.	West Bay Parkway from Walton County to SR 79 (needed to meet future demand)	FDOT 5-Year Work Program	PD&E Study	\$181				Ongoing
25.	Front Beach Road (Portside Dr. to SR 79)	FDOT 5-Year Work Program	Construct Sidewalk	\$488,576				

Recreation & Open Space		Funding Source	Current Status	FY 17-18	FY 18-19	FY 19-20	FY 20-21	Beyond 21-22
26.	Multi Use Path/Trail From East Side of Trieste Subdiv. Breakfast Point Subdivision	City Matching Funds & Sun Trail Grant	Preliminary Eng.	\$92,864 City	\$904,716 Grant \$133,315 City			
Schools								
27.	See Note #2 at end of report.	School Board						

Potable Water, Wastewater, and Reuse		Funding Source	Current Status	FY 17-18	FY 18-19	FY 19-20	FY 20-21	Beyond 21-22
Potable Water								
28.	N. Pier Park Drive Water Main	Utility	\$64,001 <i>Balance to Finish</i>	\$64,001				
29.	Bid-A-Wee Ph 1 Water Main Replacements	Utility	\$662,268 <i>Balance to Finish</i>	\$350,000	\$312,268			
30.	Bid-A-Wee Ph 2 Water Main Replacements	Utility	\$285,000 <i>Balance to Finish</i>		\$285,000			
31.	CRA SR 79 Water Main Relocations & Reclaimed	Utility	\$700,000 <i>Total Cost</i>		\$300,000	\$400,000		
32.	Bay Parkway to Nautilus Water Main	Utility	\$575,000 <i>Total Cost</i>		\$100,000	\$475,000		
Wastewater and Reuse								
33.	All Coleman Force Main Project	Utility	\$652,000 <i>Total cost</i>	\$100,000	\$400,000	\$152,000		
34.	Waste / Reclaimed System extentions / loops	Utility	\$1,610,000 <i>Balance to Finish</i>	\$200,000	\$200,000	\$200,000	\$200,000	\$810,000

Potable Water, Wastewater, and Reuse		Funding Source	Current Status	FY 17-18	FY 18-19	FY 19-20	FY 20-21	Beyond 21-22
35.	Now Wastewater Treatment site 28 Acres	Utility	\$2,200,000 <i>Total cost</i>	\$100,000	\$2,100,000			
36.	CRA SR 79 Sewer Main Relocation & Reclaimed Mains	Utility	\$850,000 <i>Total Cost</i>		\$700,000	\$150,000		
37.	Bay Parkway to Nautilus Forcemain and Reclaimed Mains	Utility	\$2,185,000 <i>Total cost</i>		\$800,000	\$1,385,000		
38.	Lift Station #4 Driftwood Replacement	Utility	\$1,992,000 <i>Balance to Finish</i>	\$250,000		\$1,100,000	\$642,000	

Stormwater		Funding Source	Current Status	FY 17-18	FY 18-19	FY 19-20	FY 20-21	Beyond 21-22
39.	Stormwater Improvements	Stormwater Utility Assessments		\$2,200,000	\$550,000	\$555,000	\$500,000	

Prop. Share Projects		Funding Source	Current Status	FY 17-18	FY 18-19	FY 19-20	FY 20-21	Beyond 21-22
1.	US 98 Int. w/ Hill Rd. and US 98 Int. w/ Clara Avenue (needed to meet future demand)	Seahaven Prop. Share	\$300,000 based on trip triggers					
2.	US 98-Hill Rd. 6-laning (needed to meet future demand)	Seahaven Prop. Share	\$1,350,000 (trip triggers)					
3.	US 98-Clara Ave. 6-laning (needed to meet future demand)	Seahaven Prop. Share	\$1,350,000 (trip triggers)					
4.	PD&E for US 98 from SR 79 to Thomas Drive flyover (needed to meet future demand)	Seahaven Prop. Share	\$2,000,000 (trip triggers)					
5.	ITS for US 98 from Phillips Inlet to Thomas Dr. flyover (needed to meet future demand)	Seahaven Prop. Share	\$1,000,000 (trip triggers)					
6.	Hill Rd. Improvements (needed to meet future demand)	Seahaven Prop. Share	\$938,766 (trip triggers)					

Notes

1. The City of Panama City Beach hereby adopts by reference the most current 5-year Schedule of Improvements as formally adopted by the FDOT, District 3 and the Bay County TPO.
2. The City of Panama City Beach hereby adopts by reference the Bay County School District's 2017-2018 Work Plan.
3. The FBR-CRA is funded with tax increment payments from Bay County. The amount of tax increment expected for FY 17/18 is approximately \$11,000,000.
4. The City of Panama City Beach will coordinate with the most current Water Supply Plan as formally adopted by the Northwest Florida Water Management District.

REGULAR AGENDA

ITEM 2



CITY OF PANAMA CITY BEACH AGENDA ITEM SUMMARY

1. DEPARTMENT MAKING REQUEST/NAME:

ADMIN/LEGAL

2. MEETING DATE:

DECEMBER 14, 2017

3. REQUESTED MOTION/ACTION:

HOLD PUBLIC HEARING AND APPROVE RESOLUTION ANNOUNCING CITY INTENT TO USE THE UNIFORM METHOD OF COLLECTION FOR NON AD-VALOREM ASSESSMENTS

4. AGENDA

PRESENTATION

PUBLIC HEARING

CONSENT

REGULAR

5. IS THIS ITEM BUDGETED (IF APPLICABLE)? YES NO N/A
BUDGET AMENDMENT OR N/A

DETAILED BUDGET AMENDMENT ATTACHED YES NO N/A

6. BACKGROUND: (WHY IS THE ACTION NECESSARY, WHAT GOAL WILL BE ACHIEVED)

The City Council must provide notice, pursuant to Section 197.3632(3)(a), Florida Statutes, of its intent to use the uniform method of collecting non-ad valorem assessments levied within the City for the cost of providing capital improvements or equipment, and/or essential services, and/or unpaid rates, fees and charges associated with such services and facilities. This is called the uniform collection method, allowed by state statute, for collection and enforcement thereof on the same bill and in the same manner as for collection of taxes. State law requires that the City consider the adoption of a resolution electing to use the uniform method of collecting such assessments authorized by Section 197.3632, Florida Statutes, at a public hearing noticed by publication each week for 4 weeks prior to consideration before the end of the calendar year, or before March 1 in certain other circumstances, to be eligible to later decide to use this method beginning with the collection of taxes and non-ad valorem assessment in November. The advertisement has been placed in the Panama City News Herald as required by law and proof of publication will be affixed to the Resolution upon receipt. The Resolution states the need for the levy and contains a legal description of the boundaries of the real property subject to the levy. Any specific assessments will separately be considered during 2018 and include additional due process and other procedural compliance.

Providing this notice and the public hearing is a timely routine procedural matter, and does not address the substance of any proposed non-ad valorem assessment. Rather, this action merely preserves the opportunity to use the uniform means of collection later in the year and gives more than ample notice to the tax collector and property appraiser, as well as the public generally, of the possibility the City may do so. Any assessment imposed will involve another separately noticed public hearing.

Staff recommends approval of the attached Notice of Intent Resolution electing and preserving the ability to use the Uniform (tax bill) Method of Collecting Non-ad Valorem Assessments.

RESOLUTION NO. 18-24

A RESOLUTION OF THE CITY COUNCIL OF THE CITY OF PANAMA CITY BEACH, FLORIDA ELECTING TO USE THE UNIFORM METHOD OF COLLECTING NON-AD VALOREM ASSESSMENTS LEVIED IN ALL OR PART OF PANAMA CITY BEACH, FLORIDA STATING A NEED FOR SUCH LEVY; PROVIDING FOR THE MAILING OF THIS RESOLUTION; AND PROVIDING AN EFFECTIVE DATE.

BE IT RESOLVED BY THE CITY COUNCIL OF THE CITY OF PANAMA CITY BEACH, FLORIDA AS FOLLOWS:

SECTION 1. AUTHORITY. This Resolution is adopted pursuant to, sections 197.3632 and 197.3635, Florida Statutes (collectively, the "Uniform Collection Act"), and other applicable provisions of law.

SECTION 2. FINDINGS. It is hereby ascertained, determined and declared as follows:

(A) The City Council of the City of Panama City Beach, Florida is contemplating the imposition of one or more series of special assessments, sometimes referred to as non-ad valorem assessments, for the provision of fire protection availability and related capital improvements and/or essential services and/or unpaid, rates, fees and charges associated therewith (the "Improvements and Services").

(B) The City Council desires to preserve the option to use the uniform method for collecting non-ad valorem assessments to fund the cost of providing such Improvements and Services to property within the City of Panama City Beach, Florida as authorized by the Uniform Collection Act, which will allow such assessments to be collected each year commencing in November 2018, in the same manner as provided for ad valorem taxes. A description of the boundaries of the City of Panama City Beach, Florida is attached hereto as Exhibit A.

(C) The City Council held a duly advertised public hearing for the purpose of considering the adoption of this Resolution, proof of publication providing notice of such hearing being attached hereto as Exhibit B.

(D) The City Council intends and agrees to be bound by the statutory terms required for the use of the uniform method for collecting non-ad valorem assessments, including reimbursement to the tax collector and property appraiser of necessary administrative costs and actual costs of collection not exceeding the amounts allowed and provided for by law upon certification of the non-ad valorem assessment roll to the tax collector on a compatible electronic medium without error or omission by September 15, 2018.

SECTION 3. UNIFORM METHOD OF COLLECTING NON-AD VALOREM ASSESSMENTS.

(A) Commencing with the ad valorem tax bills issued in November 2018 and each year thereafter, the City of Panama City Beach, Florida hereby preserves the opportunity and announces its intention to use the uniform method authorized by the Uniform Collection Act for collecting non-ad valorem assessments associated with providing the Improvements and Services.

(B) The City Council hereby determines that the levy of such assessments is needed to pay or fund the cost of providing such Improvements and Services.

(C) Adoption of this Resolution is for the purpose of complying with the statutory requirements that the City Council publicly announce and inform the Florida Department of Revenue, the respective property appraisers, and tax collectors that it may levy non-ad valorem special assessments and use the uniform method of collection.

(D) Adoption of this Resolution shall not be deemed to commit or require the City Council to impose any assessments.

(E) Upon adoption, the City Manager of City of Panama City Beach, Florida, or designee thereof, is hereby directed to send a copy of this Resolution by United States mail to the Florida Department of Revenue, and the respective property appraisers and tax collectors by January 10, 2018.

SECTION 4. CONSTRUCTION; EFFECTIVE DATE. This Resolution shall be liberally construed to effect the purposes hereof and shall become effective immediately upon adoption.

DULY ADOPTED this ____ day of _____, 20____.

**THE CITY COUNCIL OF THE CITY OF
PANAMA CITY BEACH, FLORIDA**

By: _____
Mike Thomas, Mayor

ATTEST:

Jo Smith, City Clerk

EXHIBIT A

LEGAL DESCRIPTION OF
THE CITY OF PANAMA CITY BEACH, FLORIDA

The boundaries of the entirety of City of Panama City Beach, Florida, which also more particularly embrace and include:

The City of Panama City Beach shall embrace and include that territory in Bay County, Florida, described as follows: Beginning at the intersection of the water's edge of the Gulf of Mexico and the West line of the Southeast Quarter of the southwest quarter of Fractional Section 6, township 4 South, Range 15 West; thence North along said West line to a point 1023.35 feet South of the Northwest corner of the NE ¼ of the SW ¼ of said Section 6; thence S55°00'E, 190 feet; thence N35°00'E, 131.67 feet, to the South Right of Way line of Surf Drive; thence N52°47'W, and along the said South R/W of Surf Drive, 240 feet, more or less to the West R/W of Surf Drive; thence N32°27'E, and along the said West R/W of Surf Drive 402.2 feet, more or less, to the South R/W of State Road S-392 (Thomas Drive); thence Westerly, along the South R/W of SR S-392 to a point on said South R/W, which is S37°15'37"W of the following described point on the North R/W of said SR S-392 (Thomas Drive). Commencing at the NW Corner of Section 6, Township 4 South, Range 15 West, proceed South along the West line of Section 6, to the North R/W of SR S-392; thence Southeasterly along the North R/W of the curve of SR S-392 to the Point of Tangency of curve, (having a Radius of 955.37'; central angle of 49 degrees, 28') 760' more or less; thence S52°44'23"E, 291.90' to said point; thence N37°15'37"E, and across said SR S-392, to the waters edge of Grand Lagoon; thence Northwesterly along the waters edge of Grand Lagoon, to the intersection of the West line of Section 6, Township 4 South, Range 15 West; thence North, along the West line of said Section 6, to the NE corner of Fractional Section 1, Township 4 South, Range 16 West; thence West along the North line of said Section 1, and South line of Section 36, Township 3 South, Range 16 West, to the Westerly R/W of SR S-392 (Thomas Drive); thence Northerly and Westerly, along the Southerly R/W of SR S-392 to a point which is the intersection of the said Southerly R/W and a point 90 feet East of the West line of the SE ¼ of the SE ¼ of said Section 36; thence South, and 90 feet East of, and parallel to said West line of SE ¼ of SE ¼, to the South line of said Section 36; thence West, along the South line of Section 36, Township 3 South, Range 16 West, 90 feet, more or less, to the SE corner of the SW ¼ of the SE ¼ of said Section 36, thence North along the East line of said SW ¼ of SE ¼ to the intersection with the South R/W line of U.S. Highway 98; thence West along said South R/W line of U.S. Highway 98 to a point that is 1020' East of the West line of said SW ¼ of SE ¼ of Section 36; thence North, 800 feet, more or less, to the North line of said SW ¼ of SE ¼ of Section 36; thence West along the North line of said SW ¼ of SE ¼, 1020 feet to the SE Corner of the NE ¼ of the SW ¼ of said Section 36; thence North along the East line of said NE ¼ of SW ¼, ½ mile to the NE corner of the SW ¼ of said Section 36; thence West along the ½ Section Lines of Sections 36 and 35 to the NW Corner of the NE ¼ of the SE ¼ of Section 35, Township 3 South, Range 16 West; thence North along the West line of the E ½ of the NE ¼ of said Section 35, 3/10 miles, more or less, to the North R/W line of State Road S-392-A; thence Northwesterly along said North R/W line, to the West line of the E ½ of the E ½ of Section 27, Township 3 South, Range 16 West (being the quarter-quarter line); thence North along the quarter-quarter section line, to the Northeast corner of the SW ¼ of the NE ¼ of said Section 27, thence West along the quarter-quarter section line, .19 miles to the East R/W line of SR S-30-C; thence North along said East R/W line of SR S-30-C, .23 miles to the North R/W line of SR S-30-A; thence Westerly along the North R/W line of SR S-30-A, .20 miles; thence North 1141.13'; thence N42°33'41"W, 125' to the existing East Boundary Line of the East Leg of the West Bay Golf Course; thence Northerly along said Golf Course, .67 miles to the North line of Section 22, Township 3 South, Range 16 West; thence West

along said North line, ¼ mile to the SW Corner of the E ½ of U.S. government Lot 4 of Section 15, Township 3 South, Range 16 West; thence North along the West line of the E ½ of Government Lot 4, 567.02'; thence West, 660.68' to the West line of Section 15, Township 3 South, Range 16 West; thence South along the West line of Section 15, 567.02' to the NW Corner of Section 22, Township 3 South, Range 16 West; thence South along the West line of Section 22, ¾ mile; thence East, 1/8 mile; thence South, ¼ mile to the South section line; thence West along said South Section line, 1/8 mile to the SW Corner of said Section 22; thence continue West along the Section line, ½ mile to the SW corner of the SE ¼ of Section 21, Township 3 South, Range 16 West; thence North along the half section line, ½ mile to the center of said Section 21; thence West along the half section line, ¾ mile; thence North along the quarter-quarter section line, ¼ mile; thence West along the quarter-quarter section line, ½ mile; thence North along the quarter-quarter section line, ¼ mile to the South line of Section 17, Township 3 South, Range 16 West; thence West, ¼ mile to the West line of said Section 17; thence North along said section line and the East Boundary Line of Gulf Highlands Subdivision to the NE Corner of said Subdivision; thence Westerly along the North Boundary Line of said Subdivision to the East R/W line of State Road S-79; thence Northerly along the East R/W line of said State Road S-79 to the South line of Section 7, Township 3 South, Range 16 West; thence West along the South lines of Section 7 and Section 12, Township 3 South, Range 17 West, to the SE corner of the SW ¼ of the SW ¼ of said Section 12; thence North along the quarter-quarter section line, ¼ mile; thence West along the quarter-quarter section line, ¼ mile to the West line of said Section 12; thence North along said West line, ¼ mile; thence West along the quarter-quarter section line of Section 11, Township 3 South, Range 17 West, ¼ mile; thence South along the quarter-quarter section line, ½ mile to the North line of Fractional Section 14, Township 3 South, Range 17 West; thence West along said North line to the Gulf of Mexico; thence South, 300'; thence Southeasterly following the meanderings of the Gulf of Mexico and always 300' Southwesterly therefrom, approximately 11.50 miles to a point that is 300' South of the Point of Beginning; thence North, 300' to the Point of Beginning.

TOGETHER WITH ALL LANDS ANNEXED INTO THE CITY PURSUANT TO ORDINANCES ADOPTED BY THE CITY.

LESS AND EXCEPT THE FOLLOWING PARCEL:

Begin at the Southeast Corner of that certain parcel conveyed by Long Beach Resorts, Inc. to W.J. Braswell, et ux, dated March 21, 1950, and recorded in Bay County, Florida Deed Book 144, at page 299; thence West along the South line of said Braswell property (South line of Section 36, Township 3 South, Range 16 West) to the West line of Gulf Drive; thence North along the West line of Gulf Drive to the intersection of the Southerly right-of-way line of U.S. Highway 98; thence Easterly along said Southerly right-of-way of U.S. Highway 98 to the Northwest corner of that certain parcel described in Ordinance #144 of the City of Panama City Beach, enacted July 28, 1971, and recorded in Bay County Official records Book 399, at page 692; thence Southerly 257 feet more or less to the water's edge of a lake; thence Easterly along said lake 300 feet more or less to a point South of the Northeast Corner of said parcel described in Ordinance #144 and to the East line of the said Braswell parcel; thence south to the Point of Beginning.

EXHIBIT B

PROOF OF PUBLICATION

[attach the affidavit and proof of publication from newspaper]

REGULAR AGENDA

ITEM 3



CITY OF PANAMA CITY BEACH AGENDA ITEM SUMMARY

1. DEPARTMENT MAKING REQUEST/NAME:

Administration- Mario Gisbert

2. MEETING DATE:

December 14, 2017

3. REQUESTED MOTION/ACTION:

Appointment of Non-Collector seat on the TDC for a 4 year term.

4. AGENDA

PRESENTATION

PUBLIC HEARING

CONSENT

REGULAR

5. IS THIS ITEM BUDGETED (IF APPLICABLE)? YES NO N/A
BUDGET AMENDMENT OR N/A

DETAILED BUDGET AMENDMENT ATTACHED YES NO N/A

6. BACKGROUND: (WHY IS THE ACTION NECESSARY, WHAT GOAL WILL BE ACHIEVED)

Gary Walsingham is the City's current appointee for the Non-Collector seat, and his term will expire December 31, 2017. The Council directed staff to advertise for the appointment, and 3 applications were received:

- 1) Jeffrey DiBenedictis
- 2) Marlin (Skip) Stoltz
- 3) Gary Walsingham (current member)

Staff requests the Council appoint a Non-Collector on the TDC for a 4 year term.

BALLOT

Council selection for TDC Non-Collector seat. 4 year term thru 12/31/21.

Jeffrey DiBenedictis

Marlin (Skip) Stoltz

Gary Walsingham (current member)

Choice:

Signature

12/14/17

AGENDA ITEM #

3

COMMITTEE VOLUNTEER----- NON-COLLECTOR
BAY COUNTY TOURIST DEVELOPMENT COUNCIL (TDC) APPLICATION
PLEASE PRINT

NAME: Jeffrey Keith DiBenedictis

HOME ADDRESS: 5340 Hopetown Lane, PCB FL 32408

MAILING ADDRESS: 5340 Hopetown Lane, PCB FL 32408

Home Phone (850) 233-3337 Business Phone (850) 249-4659 Cell (850) 708-5101
How is it best to contact you during the day? Cell phone

E-mail Address: pcbancr67@me.com Fax Number: (850) 238-8643

Are you a registered voter in Bay County? Yes No
Do you currently hold an elected or appointed public office? Yes No
If yes, which one(s)? N/A

Please list the names, addresses and types of businesses you own or operate within the County that make you eligible for this position.

Are you involved with any other businesses or agencies contracted or regulated by the City of Panama City Beach, Panama City Beach Convention and Visitors Bureau, or Bay County?
If yes, please explain: N/A

Do you have any relatives employed or contracted by the City of Panama City Beach, Panama City Beach Convention and Visitors Bureau, or Bay County?
If yes, please explain: NO

TDC meets the second Tuesday of each month at 9AM at the City Hall Annex. This is a four year term.

I have read and understood Section 112.313, Florida Statutes, setting forth the standards of conduct for public officials and hereby affirm my eligibility to serve on the TDC Board in a voluntary capacity.

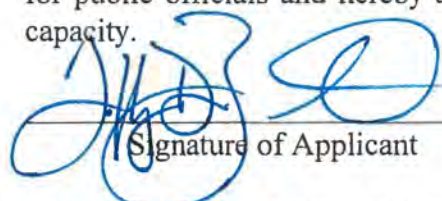
Signature of Applicant

11/15/17
Date

Please return the completed form to Jo Smith, at the City Manager's office in person, via email to jsmith@pcb.gov or via fax at (850) 233-5108. Closing Date for resumes and applications is November 30, 2017, at Noon. Council will make their choices 12/14/17 at their 6 P.M. meeting.

PLEASE ATTACH RESUME.

Any questions, please phone 233-5100 and ask for Jo; or email jsmith@pcb.gov.

NOV 20 2017
AGENDA ITEM # MAYOR & CITY MANAGER 2

JEFFREY K. DIBENEDICTIS

5340 Hopetown Lane, Panama City Beach FL 32408
Home: (850) 230-3337 / Cell: (850) 708-5101 / jdibenedictis@gmail.com

EXECUTIVE PROFILE

Banking executive with 27 years of experience progressively increasing responsibilities focused on accounts development and retention, while increasing market share. I was dedicated to delivering a high level of customer service to clients while concentrating on achieving corporate goals and objectives.

SKILL HIGHLIGHTS

- Leadership/communication skills
- Product development and client account management
- Self-Motivated with strong negotiation skills

PROFESSIONAL EXPERIENCE

Summit Bank N.A., Panama City FL
Senior Vice President/Commercial Lending Officer

June 2014 to Present

- Successfully opened a branch on Panama City Beach in January 2015
- Balance Sheet has grown to over \$50MM in Assets
- Strong Community involvement

Trustmark National Bank, Panama City, FL
Executive Vice President/Commercial Banking Manager

March 2012 to May 2014

- Commercial Banking Manager with 12 direct reports responsible for all commercial banking in 8 branch locations
- Handled all function related to managing and accessing risk associated with a \$187MM loan portfolio
- Successfully developed and implemented an "Officer Calling Program" (290 calls 1st qtr. 2014)
- Mentored and coached Associates following two operational mergers creating a positive seamless transition to the customer base

June 2002 to March 2012

- Market President for 12 years supervising four branch locations and commercial banking concentrating on all aspects of market growth
- Exceeding budgetary goals each year starting in 2002 through 2007

June 1996 to June 2002

- Senior Lender and Market Leader for The Bank f/k/a Emerald Coast Bank
- One of the original seven Officer that helped organize and open a *denovo* bank

EDUCATION

- Florida State University, Tallahassee FL 1985-1989
- Bachelor of Science, Economics

COMMUNITY SERVICE

- Board Member -Gulf Coast State College Foundation- since 2000
 - Executive Committee February 2015 to Present
 - Foundation President February 2016 to February 2017
- Board Member -Panama City Beach Chamber of Commerce-since 2012
 - Executive Committee October 2017
- Executive Leadership Team-American Heart Association-2012
- Inaugural Chairman for March of Dimes Signature Chef Fundraiser 2010 and 2011

References furnished upon request

COMMITTEE VOLUNTEER----- NON-COLLECTOR
BAY COUNTY TOURIST DEVELOPMENT COUNCIL (TDC) APPLICATION
PLEASE PRINT

NAME: MARLIN (SKIP) STOLTZ
HOME ADDRESS: 318 Bainbridge Street PCB, FL 32413
MAILING ADDRESS: SAME

Home Phone: 850 249 0247 Business Phone: _____ Cell: 850 276 6111
How is it best to contact you during the day? _____

E-mail Address: SKIPSTOLTZ@KNOWLOGY.NET Fax Number: 850 249 0303

Are you a registered voter in Bay County? Yes No
Do you currently hold an elected or appointed public office? Yes No
If yes, which one(s)? _____

Please list the names, addresses and types of businesses you own or operate within the County that make you eligible for this position.

All 5 Domino's PIZZAS in Bay County
2 STORES ON the BEACH

Are you involved with any other businesses or agencies contracted or regulated by the City of Panama City Beach, Panama City Beach Convention and Visitors Bureau, or Bay County?
If yes, please explain: NO

Do you have any relatives employed or contracted by the City of Panama City Beach, Panama City Beach Convention and Visitors Bureau, or Bay County?
If yes, please explain: NO

TDC meets the second Tuesday of each month at 9AM at the City Hall Annex. This is a four year term.

I have read and understood Section 112.313, Florida Statutes, setting forth the standards of conduct for public officials and hereby affirm my eligibility to serve on the TDC Board in a voluntary capacity.

Marlin Stoltz _____
Signature of Applicant Date 11.13.17

Please return the completed form to Jo Smith, at the City Manager's office in person, via email to jsmith@pcb.gov or via fax at (850) 233-5108. Closing Date for resumes and applications is November 30, 2017, at Noon. Council will make their choices 12/14/17 at their 6 P.M. meeting.

PLEASE ATTACH RESUME.

Any questions, please phone 233-5100 and ask for Jo; or email jsmith@pcb.gov.

RECEIVED
NOV 15 2017
AGENDA ITEM # 3
OFFICE OF THE MAYOR
CITY MANAGER

Marlin G Stoltz (Skip)

318 Bainbridge Street

Panama City Beach, Fl 32413

850-276-6111 skipstoltz@knology.net

- *Lived in Panama City Beach for 15 Years
- *Served on the Board of Directors for the Panama City Beaches Chamber of Commerce 5 Years.
- * Served as Chairman of the Ambassador Team for the Beaches Chamber of Commerce for 5 years and still on the Chamber Ambassador Team.
- * Currently serve as Board President for Beach Care Services a Local Charitable organization
- * Served on Home Owner Association Boards
- * Have Knowledge of all of Panama City Beach and Surrounding Areas
- * Have Knowledge of the tourist Industry and how it affects the Beach Area
- * Served on the Board for Florida's Mortgage Brokers and Bankers Committee
- * Served on the Leader Ship Board for Delta Airlines

COMMITTEE VOLUNTEER----- NON-COLLECTOR
BAY COUNTY TOURIST DEVELOPMENT COUNCIL (TDC) APPLICATION
PLEASE PRINT

NAME: GARY WALSHINGHAM

HOME ADDRESS: 1122 REDFISH CIRCLE

MAILING ADDRESS: P.O. BOX 28089

Home Phone: 934-1066 Business Phone: 936-1290 Cell: 832-8777
How is it best to contact you during the day? _____

E-mail Address: gwalsingham@aol.com Fax Number: 936-1291

Are you a registered voter in Bay County? Yes No
Do you currently hold an elected or appointed public office? Yes No
If yes, which one(s)? _____

Please list the names, addresses and types of businesses you own or operate within the County that make you eligible for this position.

WONDERWORKS

Are you involved with any other businesses or agencies contracted or regulated by the City of Panama City Beach, Panama City Beach Convention and Visitors Bureau, or Bay County?

If yes, please explain: PROPERTY

Do you have any relatives employed or contracted by the City of Panama City Beach, Panama City Beach Convention and Visitors Bureau, or Bay County?

If yes, please explain: NO

TDC meets the second Tuesday of each month at 9AM at the City Hall Annex. This is a four year term.

I have read and understood Section 112.313, Florida Statutes, setting forth the standards of conduct for public officials and hereby affirm my eligibility to serve on the TDC Board in a voluntary capacity.

Gary Walshingham
Signature of Applicant

11-14-17
Date

Please return the completed form to Jo Smith, at the City Manager's office in person, via email to jsmith@pcb.gov or via fax at (850) 233-5108. Closing Date for resumes and applications is November 30, 2017, at Noon. Council will make their choices 12/14/17 at their 6 P.M. meeting: **ED**

PLEASE ATTACH RESUME.

Any questions, please phone 233-5100 and ask for Jo; or email jsmith@pcb.gov. **NOV 14 2017**

IN OFFICE OF MAYOR & CITY MANAGER
AGENDA ITEM # 3

REGULAR AGENDA

ITEM 4



CITY OF PANAMA CITY BEACH AGENDA ITEM SUMMARY

1. DEPARTMENT MAKING REQUEST/NAME:

Administration

2. MEETING DATE:

12/14/2017

3. REQUESTED MOTION/ACTION:

Staff requests appointment of Police and Fire personnel who are City residents to the Police and Fire Pension Boards.

4. AGENDA

PRESENTATION

PUBLIC HEARING

CONSENT

REGULAR

5. IS THIS ITEM BUDGETED (IF APPLICABLE)? YES NO N/A
BUDGET AMENDMENT OR N/A

DETAILED BUDGET AMENDMENT ATTACHED YES NO N/A

6. BACKGROUND: (WHY IS THE ACTION NECESSARY, WHAT GOAL WILL BE ACHIEVED)

Florida Statutes 175 and 185, as well as the City's ordinances specifying the makeup of the respective pension boards, (applicable to Police and Fire), require that the Council appointments to these boards be City residents. Ms. White, who is the City appointee on both Boards, does not live within the City limits. Additionally, Firefighter Shawn Legleiter is not a City resident and is the other City appointee to the Firefighters' Pension Board. Both Boards discussed the issue at their quarterly meeting held November 30, 2017.

The Police Officers' Pension Board recommends that Captain Rich McClanahan be appointed to their Board to replace Ms. White.

The Firefighters' Pension Board directed Ms. Smith to send a memo to all fire department personnel to determine which firefighters living within the City limits might be interested in serving on the Board. Two Firefighters, Robert Spivey and J.J. Roberts, have expressed interest. Staff recommends that the Council consider appointing Firefighter Spivey and Firefighter Roberts to replace Ms. White and Firefighter Legleiter.

REGULAR AGENDA

ITEM 5



CITY OF PANAMA CITY BEACH AGENDA ITEM SUMMARY

1. DEPARTMENT MAKING REQUEST/NAME:

Administration- Mario Gisbert

2. MEETING DATE:

December 14, 2017

3. REQUESTED MOTION/ACTION:

Update the Police Officers' Retirement Plan regarding the Normal Retirement Age and Date, and recommend approval of the First Reading of Ordinance 1445.

4. AGENDA

PRESENTATION

PUBLIC HEARING

CONSENT

REGULAR

5. IS THIS ITEM BUDGETED (IF APPLICABLE)? YES NO N/A
BUDGET AMENDMENT OR N/A

DETAILED BUDGET AMENDMENT ATTACHED YES NO N/A

6. BACKGROUND: (WHY IS THE ACTION NECESSARY, WHAT GOAL WILL BE ACHIEVED)

Recently, the Police Officers' Retirement Plan was amended by Ordinance 1419 (adopted 10/12/17) to allow retirement after twenty-five (25) years of Credited Service, regardless of age, and include a one hundred fifty dollar (\$150.00) supplemental benefit which is funded with state premium tax rebate funds at no cost to the City.

Proposed Ordinance 1445 is necessary to update Section 1 (1) pertaining to the Normal Retirement Age and Date to correspond to the aforementioned Ordinance 1419.

ORDINANCE NO. 1445

AN ORDINANCE OF THE CITY OF PANAMA CITY BEACH FURTHER AMENDING THE CITY OF PANAMA CITY BEACH POLICE OFFICERS' RETIREMENT PLAN, ADOPTED PURSUANT TO ORDINANCE NO. 1159, AS SUBSEQUENTLY AMENDED; AMENDING SECTION 6, BENEFIT AMOUNTS AND ELIGIBILITY; REPEALING ALL ORDINANCES IN CONFLICT HERewith AND PROVIDING FOR AN EFFECTIVE DATE.

BE IT ORDAINED BY THE CITY COUNCIL OF THE CITY OF PANAMA CITY BEACH, FLORIDA;

SECTION 1: That the City of Panama City Beach Police Officers' Retirement Plan, adopted by ordinance number 1159, as subsequently amended, is hereby further amended by amending Section 6, Benefit Amounts and Eligibility, subsection 1., Normal Retirement Date, to read as follows (new text **bold and underlined**, deleted text ~~struckthrough~~):

1. Normal Retirement Age and Date.

~~A Member's normal retirement date shall be the first day of the month coincident with, or next following the earlier of the attainment of age fifty (50) and the completion of twenty (20) years of Credited Service, or, the attainment of age fifty five (55) and the completion of ten (10) years of Credited Service. A Member may retire on his normal retirement date or on the first day of any month thereafter, and each Member shall become one hundred percent (100%) vested in his accrued benefit on the Member's normal retirement date. Normal retirement under the System is Retirement from employment with the City on or after the normal retirement date.~~

A Member's normal retirement age is the earlier of the attainment of age fifty (50) and the completion of twenty (20) years of Credited Service, the attainment of age fifty-five (55) and the completion of ten (10) years of Credited Service, or the completion of twenty-five (25) years of Credited Service, regardless of age. Each Member shall become one hundred percent (100%) vested in his accrued benefit at normal retirement age. A Member's normal retirement date shall be the first day of the month coincident with or next following the date the Member retires from the City after attaining normal retirement age.

* * *

SECTION 2: All Ordinances or parts of Ordinances in conflict herewith be and the same are hereby repealed.

SECTION 3: That this Ordinance shall become effective upon its adoption.

PASSED, APPROVED AND ADOPTED at the regular meeting of the City Council of the City of Panama City Beach, Florida, this _____ day of _____, 2017.

AGENDA ITEM # 5

MIKE THOMAS, MAYOR

Ordinance 1445

ATTEST:

JO SMITH, CITY CLERK

EXAMINED AND APPROVED by me this ____ day of _____, 2017.

MIKE THOMAS, MAYOR

Published in the _____ on the ____ day of _____, 2017

Posted on pcbgov.com on the ____ day of _____, 2017.

AGENDA ITEM # 5

Ordinance 1445

REGULAR AGENDA

ITEM 6



CITY OF PANAMA CITY BEACH AGENDA ITEM SUMMARY

1. DEPARTMENT MAKING REQUEST/NAME:
Panama City Beach Police Department

2. MEETING DATE:
12/14/2017

3. REQUESTED MOTION/ACTION:
Request Budget Amendment for PCBPD Outreach Program to Fight Against Speed and Aggressive Driving SC-18-13-10

4. AGENDA
PRESENTATION
PUBLIC HEARING
CONSENT
REGULAR

5. IS THIS ITEM BUDGETED (IF APPLICABLE)? YES NO N/A
BUDGET AMENDMENT OR N/A

DETAILED BUDGET AMENDMENT ATTACHED YES NO N/A

6. BACKGROUND: (WHY IS THE ACTION NECESSARY, WHAT GOAL WILL BE ACHIEVED)
The Police Department has been approved by the Florida Department of Transportation for the PCBPD Outreach Program to Fight Against Speed and Aggressive Driving (SC-18-13-10) reimbursement grant. The grant amount is \$50,000 and is used for overtime salaries and benefits for saturation patrols; which are designed to enhance public awareness and compliance of safe driving practices to reduce traffic crashes and fatalities. The overtime can begin immediately upon approval of the budget amendment.

NOTE: Grant authorized funding cannot be utilized to supplant an officer's normal scheduled overtime.

AGENDA ITEM # 60

RESOLUTION 18-21

A RESOLUTION OF THE CITY OF PANAMA CITY BEACH, FLORIDA; AUTHORIZING A BUDGET AMENDMENT TO REFLECT THE RECEIPT OF A \$50,000 GRANT FROM THE FLORIDA DEPARTMENT OF TRANSPORTATION; AND PROVIDING AN IMMEDIATELY EFFECTIVE DATE.

WHEREAS, on November 6, 2017, the City received notification of award of the Florida Department of Transportation Reimbursement Grant in the amount of \$50,000 for the project entitled PCBPD Outreach Program to Fight Against Speed and Aggressive Driving; and

WHEREAS, a budget amendment is necessary to reflect the total revenue of \$50,000 to be received from the grant and the expenditure of those funds for overtime and related benefits requested in the grant agreement.

NOW THEREFORE BE IT RESOLVED by the City Council of the City of Panama City Beach, that:

1. The following budget amendment #3 is adopted for the City of Panama City Beach, Florida, for the fiscal year beginning October 1, 2017, and ending September 30, 2018, as shown in and in accordance with the attached and incorporated Exhibit A.
2. This Resolution shall take effect immediately upon passage.

PASSED, APPROVED AND ADOPTED, at the regular meeting of the City Council of the City of Panama City Beach, Florida this 14th day of December, 2017.

CITY OF PANAMA CITY BEACH

By: _____
Mike Thomas, Mayor

ATTEST:

Jo Smith, City Clerk

Resolution 18-21
AGENDA ITEM # 6

**CITY OF PANAMA CITY BEACH
BUDGET TRANSFER FORM BF-10**

No. BA # 3

FUND	GENERAL ACCOUNT NUMBER	ACCOUNT DESCRIPTION	APPROVED BUDGET	BUDGET ADJUSTMENT	NEW BUDGET BALANCE
TO	001-0000-331.20-40	Federal Grants FDOT Fight Against Speed and Aggressive Driving	0.00	(50,000.00)	(50,000.00)
TO	001-2101-521.14-10	Salaries Overtime	360,000.00	40,115.00	400,115.00
TO	001-2101-521.21-10	Matching FICA	332,515.00	3,065.00	335,580.00
TO	001-2101-521.22-20	Retirement Sworn	585,000.00	6,820.00	591,820.00
		Check Adjustment Totals:	1,277,515.00	0.00	1,277,515.00

BRIEF JUSTIFICATION FOR BUDGET ADJUSTMENT:

To record award of FDOT Outreach grant to Fight Against Speed and Aggressive Driving and to reflect the expenditure of such funds per the grant award - overtime and related benefits

ROUTING FOR APPROVAL

_____ DEPARTMENT HEAD _____ DATE _____ CITY MANAGER _____ DATE
 _____ FINANCE DIRECTOR _____ DATE

Exhibit A

AGENDA ITEM #

6



Florida Department of Transportation

RICK SCOTT
GOVERNOR

605 Suwannee Street
Tallahassee, FL 32399-0450

MIKE DEW
SECRETARY

November 6, 2017

Drew Whitman, Chief of Police
Panama City Beach Police Department
17115 Panama City Beach Pkwy
Panama City Beach, Florida 32413

RE: Project Name: PCBPDP Outreach Program to Fight Against Speed and Aggressive Driving
Project Number: SC-18-13-10
DOT Contract Number: G0003

Dear Chief Whitman:

Your application to the Florida Department of Transportation for highway safety funds has been approved. We are pleased to make this award in the amount of **\$50,000.00** for the purpose of implementing the **PCBPDP Outreach Program to Fight Against Speed and Aggressive Driving** project.

A copy of the approved sub-grant agreement referenced above is enclosed for your file. All correspondence with the Department should always refer to the project name, project number, and the Department's contract number.

The effective date of the sub-grant agreement is **November 6, 2017** and only those costs incurred on or after that date and on or before **September 30, 2018** are eligible for reimbursement.

Please review Part V of the sub-grant agreement entitled "Acceptance and Agreement." This section contains the legal conditions of your subgrant award.

We look forward to working with you on this project. If you have any questions or need assistance, please contact your Traffic Safety Program Manager Ximena Smith at (850) 414-4026, who will be coordinating this activity.

Sincerely,

Chris Craig, CPM, FCCM
Traffic Safety Administrator

CC/sm
Enclosures
cc: Contract File
Financial File

www.fdot.gov

AGENDA ITEM # 6

To: Shana.Morris@dot.state.fl.us

**FLORIDA DEPARTMENT OF TRANSPORTATION
FUNDS APPROVAL**

G0Q03

9/22/2017

CONTRACT INFORMATION

Contract:	G0Q03
Contract Type:	GD - GRANT DISBURSEMENT (GRANT)
Method of Procurement:	G - GOVERNMENTAL AGENCY (287.057, F.S.)
Vendor Name:	CITY OF PANAMA CITY BEACH
Vendor ID:	F596045116012
Beginning Date of This Agreement:	10/01/2017
Ending Date of This Agreement:	09/30/2018
Contract Total/Budgetary Ceiling:	ct = \$50,000.00
Description:	SC-18-13-10, Panama City Bch PD, Outreach Program to Fight Against Speed & Aggressive Driving

FUNDS APPROVAL INFORMATION

FUNDS APPROVED/REVIEWED FOR ROBIN M. NAITOVE, CPA, COMPTROLLER ON 9/22/2017

Action:	Original
Reviewed or Approved:	APPROVED
Organization Code:	55671000961
Expansion Option:	A6
Object Code:	780000
Amount:	\$50,000.00
Financial Project:	19024518401
Work Activity (FCT):	174
CFDA:	20.600
Fiscal Year:	2018
Budget Entity:	55150200
Category/Category Year:	088796/18
Amendment ID:	0001
Sequence:	00
User Assigned ID:	
Enc Line (6s)/Status:	0001/04

Total Amount: \$50,000.00

STATE OF FLORIDA DEPARTMENT OF TRANSPORTATION (FDOT)
SUBGRANT FOR HIGHWAY TRAFFIC SAFETY FUNDS

500-065-01
 SAFETY
 07/17

<i>For FDOT Use Only</i> Project Number: SC-18-13-10	FDOT Contract Number: G0Q03
Federal Funds Awarded: \$50,000.00	FDOT DUNS Number: 80-939-7102
Federal Award Identification Number (FAIN): 18X92041020FL17	FAIN Award Date: 01/2017
Subgrant Award (Start) Date: 11/06/2017	Subgrant End Date: 9/30/2018
Amendment Number and Dates:	
Part I: GENERAL ADMINISTRATIVE INFORMATION (See Instructions)	
1. Project Title: PCBPD Outreach Program to Fight Against Speed and Aggressive Driving	
2. Federal Funding: \$50,000.00 Match: \$ Total Cost: \$50,000.00	
3. Subrecipient Agency: Name: City of Panama City Beach Address Line 1: 110 South Arnold Road Address Line 2: City: Panama City Beach State: FL Zip: 32413 -	4. Implementing Agency: Name: Panama City Beach Police Department Address Line 1: 17115 Panama City Beach Parkway Address Line 2: City: Panama City Beach State: FL Zip: 32413 -
5. Federal ID Number or 29 Digit FLAIR Account Number (State Agencies): 596045116	
6. DUNS Number: 018095984	
7. Chief Financial Officer: Name: Holly White Address Line 1: 110 South Arnold Road Address Line 2: City: Panama City Beach State: FL Zip: 32413 - Telephone No: (850) 233 - 5100 ext. E-Mail Address: hwhite@pcb.gov.com	8. Project Director: Name: Rich L. McClanahan Address Line 1: 17115 Panama City Beach Parkway Address Line 2: City: Panama City Beach State: FL Zip: 32413 - Telephone No: (850) 233 - 5000 ext. E-Mail Address: rmccclanahan@beachpolice.org
9. Financial Reimbursement Contact: Name: Holly White Title: Assistant to the City Manager for Finance Telephone Number: (850) 233 - 5100 ext. E-Mail Address: hwhite@pcb.gov.com	10. Project Activity Contact: Name: Rich L. McClanahan Title: Captain Telephone Number: (850) 233 - 5000 ext. E-Mail Address: rmccclanahan@beachpolice.org
11. Payment Remittance Address: Address Line 1: 110 S Arnold Rd Address Line 2: City: Panama City Beach State: FL Zip: 32413 -	

Part II: PROJECT PLAN AND SUPPORTING DATA

State clearly and in detail the aims of the project, precisely what will be done, who will be involved, and what is expected to result. Use the following major headings:

1. Statement of the Problem
2. Proposed Solution
3. Project Objectives
4. Evaluation

1. Statement of the Problem

According to the latest Florida Highway Safety Matrix (published on 12/21/2016) - Ranking of Florida Cities, (Group 3 - Populations 3,000 - 14,999), which ranked fatal and injury crashes in 116 cities between 2011 and 2015, Panama City Beach ranked number three (3) in the area of Speed and Aggressive Driving. Panama City Beach ranked in the top 25% of every category on the matrix. In the last three fiscal years, the Panama City Beach Police Department (PCBPD) has investigated 6,549 crashes. Of those, 5 have resulted in fatalities. The following data is supplied by the Department's in-house software, USA Software Inc. and the Florida Integrated Report Exchange System (FIRES) portal.

The following is a summary of the Panama City Beach Police Department from 10/01/2012 to 09/30/2015:

Fiscal Year	Citations	DUI Arrests	Crashes	Speeding Citations	Safety belt Citations
2013-2014	4,414	123	2,484	668	235
2014-2015	4,592	136	1,985	502	514
2015-2016	5,326	160	2,080	1,686	247

****These figures do not include Mutual Aid from other Law Enforcement Agencies working in the City limits****

Over the past three years, the City of Panama City Beach has experienced an increase in tourism of about 2 million visitors annually; and current estimates put our "transient" population somewhere in the area of 14 million annually. Due to a joint effort between the Police Department and Florida Department of Transportation (FDOT) funding, we have had beneficial results as follows: Total traffic collisions in the 2013 fiscal year was 2,186, and in fiscal year 2014 that number rose to 2,484, which was a 13% increase from the prior year. In the following fiscal year 2015, the number of crashes was 1,985, which is a decrease of 20% and it only increased 4% from 2015 to fiscal year 2016, with 2,080. The total number of traffic citations in the fiscal year 2013 was 5,625 and decreased in fiscal year 2014 to 4,414 which is a 21% decrease. During the fiscal year 2015, the total number of citations increased to 4,592 which is a 4% increase, and rose to 5,326 from 2015 to 2016, which is a 16% increase. This is a reflection of increased saturation patrols, contacts, and education efforts. In the fiscal year 2013, there was a total of 161 Driving Under the Influence (DUI) arrests, and in fiscal year 2014, there were 123 DUI arrests. This was a 23% decrease from the previous year. During the fiscal year 2015, there were 136 DUI arrests, which is a 10% increase from the prior year. From 2015 to 2016, that number rose 18% to 160. This can be attributed to increased saturation patrols through our combined efforts with the FDOT. The increase in citations and DUI's are due to the effectiveness of the saturation patrol and education measures.

An increase in DUI arrests and a decrease in safety belt citations are evidence that the additional resources from current FDOT traffic grant funding has been an effective tool in improving public safety. Due to such a massive increase in tourist population over the past few years and the demands placed on patrol officers for calls for service, obtaining these necessary resources will be the key to successfully reducing the number of traffic crashes, and overall safety of the community, in the City of Panama City Beach.

Panama City Beach continues to be a huge vacation destination, which brings large amounts of visitors to the area. This large increase of roadway traffic is problematic because the amount of tourist increases each year; however, the amount of officers on the road remain virtually unchanged; funding from FDOT becomes essential.

State clearly and in detail the aims of the project, precisely what will be done, who will be involved, and what is expected to result. Use the following major headings:

1. Statement of the Problem
2. Proposed Solution
3. Project Objectives
4. Evaluation

2. Proposed Solution

The PCBPD intends to implement the PCBPD Outreach Program to fight against Speed and Aggressive Driving by enforcement activities and saturation patrols. This program aims to reduce traffic crashes, fatalities, and injuries that speed and aggressive driving cause by implementing three components: enforcement, education, and engineering. FDOT subgrants over the past few years have been extremely beneficial and we hope to continue the efforts set forth by the National Highway Traffic Safety Administration (NHTSA). In order to continue making a positive impact on the reduction of traffic crashes, it is imperative that we stay on track with FDOT funding for saturation overtime patrols. Without this much needed funding our enforcement efforts would be greatly reduced. This is why we are again asking for your help with this program.

The PCBPD will review crash data periodically in order to determine high-frequency crash and fatality locations throughout our jurisdiction. The Department will then develop schedules for police department personnel to conduct strategic "Zero Tolerance" enforcement operations at those locations. The Project Director will be responsible for ensuring that the data is reviewed periodically, in order to make any possible changes. Our Agency will commit to locating and targeting high-frequency locations for this program. In addition, the Project Director or his designee will be responsible for distributing this information to all sworn personnel within the uniform patrol division, with the expectation that personnel assigned to the areas will increase law enforcement presence in those locations.

The PCBPD will also conduct educational initiatives for businesses, civic organizations, public forums, and news media outlets to raise awareness of crashes involving speed and aggressive driving. A special emphasis will be made to raise traffic safety awareness by use of social media, message boards signs, and news releases.

In order to facilitate the delivery of this traffic safety message, the PCBPD will partner with local resources, including the Community Traffic Safety Team (CTST), the Law Enforcement Liaison (LEL) Program, neighboring law enforcement agencies, and local media outlets. The Panama City Beach Police Department will also participate in the Statewide public awareness and enforcement campaigns sponsored by the Florida Department of Transportation Safety Office.

The Project Director will continually review traffic conditions involving hazardous areas, such as heavily congested areas where large crowds of pedestrians interact with vehicular traffic, to ensure overtime enforcement is being properly utilized. This is especially important during Spring Break and summertime when hundreds of thousands of pedestrians are walking and vehicles are driving along our roadways. The use of solar powered message speed feedback signs at key locations throughout the City is essential in reducing crashes and saving lives where this tremendous amount of pedestrians and vehicular traffic are present. By participating in NHTSA enforcement waves and partnering with local law enforcement agencies, CTST members, and LEL personnel, we will put our best efforts forward to lower the traffic crash statistics.

State clearly and in detail the aims of the project, precisely what will be done, who will be involved, and what is expected to result. Use the following major headings:

1. Statement of the Problem
2. Proposed Solution
3. Project Objectives
4. Evaluation

3. Project Objectives

By the end of the grant period (September 30, 2018) this project will:

1. Reduce the number of speed-related motor vehicle crashes in the City of Panama Beach/Bay County by at least 5% when compared to the previous three year average.
2. Increase speed-related enforcement contacts by 10% compared to the same period in 2016/17.
3. Conduct a minimum of 100 high visibility speed-related overtime enforcement patrols, in data driven high speed fatality related areas.
4. At a minimum, conduct at least 30 hours of speed-related overtime enforcement operations per week.

4. Evaluation

The project will be evaluated by:

1. The number of speed-related motor vehicle crashes in the City of Panama City Beach/Bay County is reduced by at least 5% when compared to the previous three year average.
2. The number of speed-related enforcement contacts compared to the same period in 2016/17.
3. The number of high visibility speed-related overtime enforcement patrols conducted in .
4. The number hours of high visibility speed-related overtime enforcement patrols conducted.

Amendment Number: _____ (FDOT Only)
Effective Date: _____ (FDOT Only)

Part III: PROJECT DETAIL BUDGET

Project Title: PCBPD Outreach Program to Fight Against Speed and Aggressive Driving

Project Number: SC-18-13-10

FDOT Contract Number: G0Q03

Each budget category subtotal and individual line item costs listed below cannot be exceeded. The FDOT State Safety Office may approve shifts between budget categories and line items via an amendment.

BUDGET CATEGORY	NARRATIVE	TOTAL COST	FEDERAL FUNDS	MATCH
A. Personnel Services Overtime Salary and Benefits for Enforcement Operations.	Overtime Salary and Benefits for Enforcement Operations. Benefits to include FICA and Retirement.	\$50,000	\$50,000	\$0
		\$ 0	\$0	\$0
		\$ 0	\$0	\$0
		\$ 0	\$0	\$0
		\$ 0	\$0	\$0
		\$ 0	\$0	\$0
		\$ 0	\$0	\$0
		\$ 0	\$0	\$0
		\$ 0	\$0	\$0
		\$ 0	\$0	\$0
		\$ 0	\$0	\$0
		\$ 0	\$0	\$0
		Subtotal		\$50,000
B. Contractual Services		\$ 0	\$0	\$0
		\$ 0	\$0	\$0
		\$ 0	\$0	\$0
		\$ 0	\$0	\$0
		\$ 0	\$0	\$0
		\$ 0	\$0	\$0
Subtotal		\$ 0	\$ 0	\$ 0
C. Expenses		\$ 0	\$0	\$0
		\$ 0	\$0	\$0
		\$ 0	\$0	\$0
		\$ 0	\$0	\$0
		\$ 0	\$0	\$0
		\$ 0	\$0	\$0
		\$ 0	\$0	\$0
		\$ 0	\$0	\$0
		\$ 0	\$0	\$0
		\$ 0	\$0	\$0
		\$ 0	\$0	\$0
		\$ 0	\$0	\$0
		\$ 0	\$0	\$0
		\$ 0	\$0	\$0
		\$ 0	\$0	\$0
		\$ 0	\$0	\$0
		Subtotal		\$ 0

Amendment Number: _____ (FDOT Only)
Effective Date: _____ (FDOT Only)

Part III: PROJECT DETAIL BUDGET

Project Title: PCBPD Outreach Program to Fight Against Speed and Aggressive Driving

Project Number: SC-18-13-10

FDOT Contract Number: G0Q03

Each budget category subtotal and individual line item costs listed below cannot be exceeded. The FDOT State Safety Office may approve shifts between budget categories and line items via an amendment.

BUDGET CATEGORY	NARRATIVE	TOTAL COST	FEDERAL FUNDS	MATCH
D. Operating Capital Outlay		\$ 0	\$0	\$0
		\$ 0	\$0	\$0
		\$ 0	\$0	\$0
		\$ 0	\$0	\$0
		\$ 0	\$0	\$0
		\$ 0	\$0	\$0
		\$ 0	\$0	\$0
		\$ 0	\$0	\$0
		\$ 0	\$0	\$0
		\$ 0	\$0	\$0
		\$ 0	\$0	\$0
		\$ 0	\$0	\$0
		\$ 0	\$0	\$0
Subtotal		\$ 0	\$ 0	\$ 0
E. Indirect Cost		\$ 0	\$0	\$0
Subtotal		\$ 0	\$ 0	\$ 0
Total Cost of Project		\$50,000	\$50,000	\$ 0

Amendment Number: _____ (FDOT Only)
Effective Date: _____ (FDOT Only)

PART IV: PERFORMANCE REPORT

Project Title: <u>PCBPD Outreach Program to Fight Against Speed and Aggressive Driving</u>
Project Number: <u>SC-18-13-10</u>
FDOT Contract Number: <u>G0Q03</u>
Minimum Performance Standards
The following are the minimum performance standards required in this subgrant agreement. The status of these standards will be reported using FDOT form number 500-065-19 Performance Report and shall be included with each request for reimbursement.
1. Conduct enforcement operations for PCBPD Outreach Program to fight against Speed and Aggressive Driving.
2. Provide performance reports.
3. Submit request(s) for financial reimbursement.
4.
5.
6.
7.
8.
9.
National Highway Traffic Safety Administration (NHTSA) Required Activity Reporting
The following statistics are required reporting for any traffic safety enforcement grant. (enforcement grants only) This information must be reported in the final narrative report FDOT form 500-065-20 and provided by October 31 st .
1. Number of seat belt citations issued during subgrant-funded enforcement activities.
2. Number of impaired driving arrests made during subgrant-funded enforcement activities.
3. Number of speeding citations issued during subgrant-funded enforcement activities.

Amendment Number: _____ (FDOT Only)
Effective Date: _____ (FDOT Only)

Part V: Acceptance and Agreement

Conditions of Agreement. Upon approval of this Subgrant for Highway Safety Funds, the following terms and conditions shall become binding. Noncompliance will result in loss of, or delays in, reimbursement of costs as set forth herein.

1. **Reports.** A Performance Report (FDOT Form No. 500-065-19) shall be provided with each request for financial reimbursement, providing the status of the subgrant minimum performance standards, as described Part IV of this subgrant agreement. A Final Narrative Report (FDOT Form No. 500-065-20), giving a chronological history of the subgrant activities, problems encountered, major accomplishments, and NHTSA Required Activity Reporting shall be submitted by October 31. Requests for reimbursement will not be processed and will be returned to the Subrecipient or Implementing Agency as unpaid if the required reports are not provided, following notification.

2. **Responsibility of Subrecipient.** The Subrecipient and its Implementing Agency shall establish fiscal control and fund accounting procedures that assure proper disbursement and accounting of subgrant funds and required non-federal expenditures. All monies spent on this project shall be disbursed in accordance with provisions of the Project Detail Budget as approved by the FDOT State Safety Office. All expenditures and cost accounting of funds shall conform to 2 CFR, Part 200, Uniform Administrative Requirements, Cost Principles, and Audit Requirements For Federal Awards, herein incorporated by reference, (hereinafter referred to as Applicable Federal Law).

3. **Compliance with Chapter 287, Florida Statutes (FS).** The Subrecipient and Implementing Agency agree to comply with all applicable provisions of Chapter 287, Florida Statutes. The following provisions are stated in this agreement pursuant to sections 287.133(2)(a) and 287.134(2)(a), Florida Statutes.

(a) Section 287.133 (2)(a), F.S.

A person or affiliate who has been placed on the convicted vendor list following a conviction for a public entity crime may not submit a bid, proposal, or reply on a contract to provide goods or services to a public entity; may not submit a bid, proposal, or reply on a contract with a public entity for the construction or repair of a public building or public work; may not submit bids, proposals, or replies on leases of real property to a public entity; may not be awarded or perform work as a contractor, supplier, subcontractor, or consultant under a contract with any public entity; and may not transact business with any public entity in excess of the threshold amount provided in s. 287.017 for CATEGORY TWO for a period of 36 months following the date of being placed on the convicted vendor list.

(b) Section 287.134 (2)(a), F.S.

An entity or affiliate who has been placed on the discriminatory vendor list may not submit a bid, proposal, or reply on a contract to provide any goods or services to a public entity; may not submit a bid, proposal, or reply on a contract with a public entity for the construction or repair of a public building or public work; may not submit bids, proposals, or replies on leases of real property to a public entity; may not be awarded or perform work as a contractor, supplier, subcontractor, or consultant under a contract with any public entity; and may not transact business with any public entity.

4. **Approval of Consultant and Contractual Service Agreements.** Prior to the execution of any contractual service agreements and prior to the actual employment of the consultant or the contractor by the Subrecipient or Implementing Agency, All consultant and contractual services agreements must be submitted to the FDOT Safety Office in draft form for review and approval. Approval of the subgrant does not constitute approval of a consultant or contractual service agreement.

All contractual service agreements shall include as a minimum the following information:

- (a) Beginning and end dates of the agreement (not to exceed the subgrant period);
- (b) Total contract amount;
- (c) Scope of work/Services to be provided;
- (d) Quantifiable, measureable, and verifiable units of deliverables;
- (e) Minimum level of service to be performed and criteria for evaluating successful completion;
- (f) Budget/Cost Analysis; and
- (g) Method of compensation/Payment Schedule.

All contractual service agreements shall contain the following statement:

The parties to this contract shall be bound by all applicable sections of Part V: Acceptance and Agreement of Project # (insert project number), FDOT Contract # (insert contract number). A final invoice must be received by (insert date) or payment will be forfeited.

5. Allowable Costs. The allowability of costs incurred under any subgrant shall be determined in accordance with the general principles of allowability and standards for selected cost items set forth in the Applicable Federal Law, state law, and the FDOT Disbursement Handbook, to be eligible for reimbursement. All funds not spent in accordance with the Applicable Federal Law will be subject to repayment by the Subrecipient. Only costs directly related to subgrant shall be allowable.

6. Travel. Travel costs for approved travel shall be submitted on the FDOT Contractor Travel Form (FDOT Form No. 300-000-06) or other approved Florida Department of Financial Services form and will be reimbursed in accordance with Section 112.061, F.S and the most current version of the *Disbursement Handbook for Employees and Managers*.

All out-of-state travel, conference travel, meeting travel which includes a registration fee, and/or out-of-subgrant-specified work area travel shall require written approval of the FDOT State Safety Office prior to the incurring of actual travel costs as being within the travel budget of the project and relevant to the project.

Out-of-state travel shall not be approved unless the specific trip is in the approved subgrant budget or the head of the Implementing Agency provides sufficient justification to prove that the travel will have significant benefits to the outcome of the subgrant activities.

The FDOT State Safety Office shall not pay for overnight lodging/hotel room rates that exceed \$150.00 per night (before taxes and fees). A Subrecipient and/or traveler will be required to expend his or her own funds for paying the overnight lodging/hotel room rate in excess of \$150.00 plus the applicable percentage of fees (other than flat fees). If multiple travelers share a room and the individual cost of the lodging/hotel exceeds the \$150 per night limit, the Subrecipient and/or travelers will be required to expend his or her own funds for paying the excess amount. If another entity is covering the cost of the overnight lodging/hotel then this paragraph does not apply.

7. Subgrant Amendments. The Subrecipient or Implementing Agency shall obtain prior written approval from the FDOT State Safety Office for changes to the agreement. Amendments to the agreement will be approved which achieve or improve upon the outcome of the subgrant work, or where factors beyond the control of the Subrecipient require the change. For example:

- (a) Changes in project activities or performance indicators set forth in the approved subgrant.
- (b) Changes in budget items and amounts set forth in the approved subgrant.
- (c) Changes to personnel in positions that are being reimbursed by this agreement.

Amendments to the subgrant agreement shall be in the form of a written request signed by the Authorized Representative of the Subrecipient or the Administrator of the Implementing Agency. Delegations of signature authority will not be accepted for amendment requests without prior written approval.

8. Reimbursement Obligation. The State of Florida's performance and obligation to reimburse the Subrecipient shall be subject to the availability of Federal highway safety funds and an annual appropriation by the Legislature. As detailed in 49 CFR, Part 29, Governmentwide Debarment and Suspension (Nonprocurement) and Governmentwide Requirements for Drug-Free Workplace (Grants), herein incorporated by reference, the Subrecipient shall not be reimbursed for the cost of goods or services received from contractors, consultants, vendors, or individuals suspended, debarred, or otherwise excluded from doing business with the Federal government. The Subrecipient or its Implementing Agency shall submit the required certification by consultants with awards in excess of the small purchase threshold fixed at 10 U.S.C. 2304(g) and 41U.S.C. 253(g) (currently \$25,000).

9. Excusable Delays. Except with respect to the defaults of Subrecipient's or Implementing Agency's consultants and contractors which shall be attributed to the Subrecipient, the Subrecipient and its Implementing Agency shall not be in default by reason of any failure in performance of this agreement in accordance with its terms if such failure arises out of causes beyond the control and without the fault or negligence of the Subrecipient or its Implementing Agency. Such causes are acts of God or of the public enemy, acts of the Government in either its sovereign or contractual capacity,

fires, floods, epidemics, quarantine restrictions, strikes, freight embargoes, and unusually severe weather, but in every case the failure to perform must be beyond the control and without the fault or negligence of the Subrecipient. If the failure to perform is caused by the failure of the Subrecipient's or its Implementing Agency's consultant or contractor to perform or make progress, and if such failure arises out of causes beyond the control of the Subrecipient, its Implementing Agency and its consultant or contractor, and without the fault or negligence of any of them, the Subrecipient shall not be deemed to be in default, unless (1) the supplies or services to be furnished by the consultant or contractor were obtainable from other sources, (2) the FDOT State Safety Office shall have ordered the Subrecipient or its Implementing Agency in writing to procure such supplies or services from other sources, and (3) the Subrecipient or its Implementing Agency shall have failed to comply reasonably with such order.

Upon request of the Subrecipient or its Implementing Agency, the FDOT State Safety Office shall ascertain the facts and extent of such failure and, if it shall be determined that any failure to perform was occasioned by any one or more of the said causes, the delivery schedule shall be revised accordingly.

10. Obligation of Subgrant Funds. Subgrant funds shall not be obligated prior to the effective date or subsequent to the end date of the subgrant period. Only project costs incurred on or after the effective date and on or prior to the end date of the subgrant are eligible for reimbursement. A cost is incurred when the Subrecipient's employee, its Implementing Agency, or approved contractor or consultant performs the service required or when goods are received by the Subrecipient or its Implementing Agency, notwithstanding the date of order.

11. Performance. In the event of default, noncompliance, or violation of any provision of this agreement by the Subrecipient, the Implementing Agency, the Subrecipient's consultant(s) or contractor(s) and supplier(s), the Subrecipient agrees that the Department will impose sanctions. Such sanctions include withholding of reimbursements, retainage, cancellation, termination, or suspension of the agreement in whole or in part. In such an event, the Department shall notify the Subrecipient and its Implementing Agency of such decision 30 days in advance of the effective date of such sanction. The sanctions imposed by the Department will be based upon the severity of the violation, the ability to remedy, and the effect on the project. The Subrecipient shall be paid only for those services satisfactorily performed prior to the effective date of such sanction.

12. Access to Public Records and Monitoring. The Department, National Highway Traffic Safety Administration (NHTSA), Federal Highway Administration (FHWA), Chief Financial Officer (CFO), and Auditor General (AG) of the State of Florida, or any of their duly authorized representatives, shall have access for the purpose of audit and examination of books, documents, papers, and records of the Subrecipient and its Implementing Agency, and to relevant books and records of the Subrecipient, its Implementing Agency, and its consultants and contractors under this agreement, as provided under Applicable Federal Law.

In addition to review of audits conducted in accordance with 2 CFR Part 200, herein incorporated by reference, monitoring procedures will include, on-site visits by Department staff, limited scope audits as defined by 2 CFR Part 200, and status checks of subgrant activity via telephone calls from FDOT State Safety Office staff to Subrecipients. By entering into this agreement, the Subrecipient and its Implementing Agency agree to comply and cooperate with monitoring procedures. In the event that a limited scope audit of the Subrecipient or its Implementing Agency is performed, the Subrecipient agrees to bring the project into compliance with the subgrant agreement. The Subrecipient further agrees to comply and cooperate with any inspections, reviews, investigations, or audits deemed necessary by the Chief Financial Officer or Auditor General.

The Subrecipient and Implementing Agency agree to comply with all provisions provided in Chapter 119 Florida Statutes. If the Subrecipient receives a public records request concerning its work undertaken pursuant to this Department subgrant, the Subrecipient must take appropriate action as required by Chapter 119, Florida Statutes. If the Subrecipient is unable to ascertain how best to comply with its obligations, it should seek the advice of counsel and/or FDOT State Safety Office.

The Department shall unilaterally cancel this subgrant if the Subrecipient or its Implementing Agency refuses to allow public access to all documents, papers, letters, or other material subject to the provisions of Chapter 119, F.S., and made or received by the Subrecipient or its Implementing Agency in conjunction with this subgrant.

Records of costs incurred under the terms of this subgrant shall be maintained and made available upon request to the Department at all times during the period of this subgrant and for five years after final payment is made. Copies of these documents and records shall be furnished to the Department upon request. Records of costs incurred include the Other Party's general accounting records and the project records, together with supporting documents and records, of the

contractor and all subcontractors performing work on the project, and all other records of the Contractor and subcontractors considered necessary by the Department for a proper audit of costs.

13. Audit. The administration of resources awarded through the Department to the Subrecipient by this Agreement may be subject to audits and/or monitoring by the Department. The following requirements do not limit the authority of the Department to conduct or arrange for the conduct of additional audits or evaluations of Federal awards or limit the authority of any State agency inspector general, the State of Florida Auditor General or any other State official. The Subrecipient shall comply with all audit and audit reporting requirements as specified below.

- (a) In addition to reviews of audits conducted in accordance with OMB Circular A-133, for fiscal years beginning before December 26, 2014, and in accordance with 2 CFR Part 200, Subpart F – Audit Requirements, for fiscal years beginning on or after December 26, 2014, monitoring procedures may include but not be limited to on-site visits by Department staff and/or other procedures including, reviewing any required performance and financial reports, following up, ensuring corrective action, and issuing management decisions on weaknesses found through audits when those findings pertain to Federal awards provided through the Department by this Agreement. By entering into this Agreement, the Subrecipient agrees to comply and cooperate fully with any monitoring procedures/processes deemed appropriate by the Department. The Subrecipient further agrees to comply and cooperate with any inspections, reviews, investigations, or audits deemed necessary by the Department, State of Florida Chief Financial Officer (CFO) or State of Florida Auditor General.
- (b) The Subrecipient, a non-Federal entity as defined by OMB Circular A-133, for fiscal years beginning before December 26, 2014, and as defined by 2 CFR Part 200, Subpart F – Audit Requirements, for fiscal years beginning on or after December 26, 2014, as a Subrecipient of a Federal award awarded by the Department through this Agreement is subject to the following requirements:
 - (1) In the event the Subrecipient expends a total amount of Federal awards equal to or in excess of the threshold established by OMB Circular A-133, for fiscal years beginning before December 26, 2014, and established by 2 CFR Part 200, Subpart F – Audit Requirements, for fiscal years beginning on or after December 26, 2014, the Subrecipient must have a Federal single or program-specific audit for such fiscal year conducted in accordance with the provisions of OMB Circular A-133, for fiscal years beginning before December 26, 2014, and in accordance with the provisions of 2 CFR Part 200, Subpart F – Audit Requirements, for fiscal years beginning on or after December 26, 2014. Part VI to this Agreement provides the required Federal award identification information needed by the Subrecipient to further comply with the requirements of OMB Circular A-133, for fiscal years beginning before December 26, 2014, and the requirements of 2 CFR Part 200, Subpart F – Audit Requirements, for fiscal years beginning on or after December 26, 2014. In determining Federal awards expended in a fiscal year, the Subrecipient must consider all sources of Federal awards based on when the activity related to the Federal award occurs, including the Federal award provided through the Department by this Agreement. The determination of amounts of Federal awards expended should be in accordance with the guidelines established by OMB Circular A-133, for fiscal years beginning before December 26, 2014, and established by 2 CFR Part 200, Subpart F – Audit Requirements, for fiscal years beginning on or after December 26, 2014. An audit conducted by the State of Florida Auditor General in accordance with the provisions of OMB Circular A-133, for fiscal years beginning before December 26, 2014, and in accordance with 2 CFR Part 200, Subpart F – Audit Requirements, for fiscal years beginning on or after December 26, 2014, will meet the requirements of this part.
 - (2) In connection with the audit requirements, the Subrecipient shall fulfill the requirements relative to the auditee responsibilities as provided in OMB Circular A-133, for fiscal years beginning before December 26, 2014, and as provided in 2 CFR Part 200, Subpart F – Audit Requirements, for fiscal years beginning on or after December 26, 2014.
 - (3) In the event the Subrecipient expends less than the threshold established by OMB Circular A-133, for fiscal years beginning before December 26, 2014, and established by 2 CFR Part 200, Subpart F – Audit Requirements, for fiscal years beginning on or after December 26, 2014, in Federal awards, the Subrecipient is exempt from Federal audit requirements for that fiscal year. However, the Subrecipient must provide a single audit exemption statement to the Department at FDOTSingleAudit@dot.state.fl.us no later than nine months after the end of the Subrecipient's audit period for each applicable audit year. In the event the Subrecipient expends less than the threshold established by OMB Circular A-133, for fiscal years beginning before December 26, 2014, and established by 2 CFR Part 200, Subpart F – Audit

Requirements, for fiscal years beginning on or after December 26, 2014, in Federal awards in a fiscal year and elects to have an audit conducted in accordance with the provisions of OMB Circular A-133, for fiscal years beginning before December 26, 2014, and in accordance with 2 CFR Part 200, Subpart F – Audit Requirements, for fiscal years beginning on or after December 26, 2014, the cost of the audit must be paid from non-Federal resources (*i.e.*, the cost of such an audit must be paid from the Subrecipient's resources obtained from other than Federal entities).

- (4) The Subrecipient must electronically submit to the Federal Audit Clearinghouse (FAC) at <https://harvester.census.gov/facweb/> the audit reporting package as required by OMB Circular A-133, for fiscal years beginning before December 26, 2014, and as required by 2 CFR Part 200, Subpart F – Audit Requirements, for fiscal years beginning on or after December 26, 2014, within the earlier of 30 calendar days after receipt of the auditor's report(s) or nine months after the end of the audit period. The FAC is the repository of record for audits required by OMB Circular A-133, for fiscal years beginning before December 26, 2014, and for audits required by 2 CFR Part 200, Subpart F – Audit Requirements, for fiscal years beginning on or after December 26, 2014, and this Agreement. However, the Department requires a copy of the audit reporting package also be submitted to FDOTSingleAudit@dot.state.fl.us within the earlier of 30 calendar days after receipt of the auditor's report(s) or nine months after the end of the audit period as required by OMB Circular A-133, for fiscal years beginning before December 26, 2014, and as required by 2 CFR Part 200, Subpart F – Audit Requirements, for fiscal years beginning on or after December 26, 2014.
 - (5) Within six months of acceptance of the audit report by the FAC, the Department will review the Subrecipient's audit reporting package, including corrective action plans and management letters, to the extent necessary to determine whether timely and appropriate action on all deficiencies has been taken pertaining to the Federal award provided through the Department by this Agreement. If the Subrecipient fails to have an audit conducted in accordance with OMB Circular A-133, for fiscal years beginning before December 26, 2014, and in accordance with 2 CFR Part 200, Subpart F – Audit Requirements, for fiscal years beginning on or after December 26, 2014, the Department may impose additional conditions to remedy noncompliance. If the Department determines that noncompliance cannot be remedied by imposing additional conditions, the Department may take appropriate actions to enforce compliance, which actions may include but not be limited to the following:
 1. Temporarily withhold cash payments pending correction of the deficiency by the Agency or more severe enforcement action by the Department;
 2. Disallow (deny both use of funds and any applicable matching credit for) all or part of the cost of the activity or action not in compliance;
 3. Wholly or partly suspend or terminate the Federal award;
 4. Initiate suspension or debarment proceedings as authorized under 2 C.F.R. Part 180 and Federal awarding agency regulations (or in the case of the Department, recommend such a proceeding be initiated by the Federal awarding agency);
 5. Withhold further Federal awards for the Project or program;
 6. Take other remedies that may be legally available.
 - (6) As a condition of receiving this Federal award, the Subrecipient shall permit the Department, or its designee, the CFO or State of Florida Auditor General access to the Subrecipient's records including financial statements, the independent auditor's working papers and project records as necessary. Records related to unresolved audit findings, appeals or litigation shall be retained until the action is complete or the dispute is resolved.
 - (7) The Department's contact information for requirements under this part is as follows:

Office of Comptroller, MS 24
605 Suwannee Street
Tallahassee, Florida 32399-0450
FDOTSingleAudit@dot.state.fl.us
- (c) The Subrecipient shall retain sufficient records demonstrating its compliance with the terms of this Agreement for a period of five years from the date the audit report is issued and shall allow the Department, or its designee, the CFO or State of Florida Auditor General access to such records upon request. The Subrecipient shall ensure that

the audit working papers are made available to the Department, or its designee, the CFO, or State of Florida Auditor General upon request for a period of five years from the date the audit report is issued unless extended in writing by the Department.

14. Cooperation with Inspector General. The sub recipient agrees to comply with Section 20.055(5), Florida Statutes, and to incorporate in all subcontracts the obligation to comply with Section 20.055(5), Florida Statutes.

15. Retention of Records. The Subrecipient shall retain sufficient records demonstrating its compliance with the terms of this agreement for a period of five years from the date the audit report is issued, and shall allow the Department, or its designee, the state CFO, or Auditor General access to such records upon request. The Subrecipient shall ensure that the independent audit working papers are made available to the Department, or its designee, the state CFO, or Auditor General upon request for a period of at least five years from the date the audit report is issued, unless extended in writing by the Department.

Records related to unresolved audit findings, appeals, or litigation shall be retained until the action is completed or the dispute is resolved. Records shall also be maintained and accessible in accordance with 49 CFR, Section 18.42 or 49 CFR, Section 19.53.

16. Procedures for Reimbursement. All requests for reimbursement of subgrant costs must be submitted on forms provided by the Department (FDOT Form Numbers 500-065-04 through 09 and 19) unless otherwise approved. Forms must be completed in detail sufficient for a proper pre-audit and post audit based on the quantifiable, measurable, and verifiable units of deliverables and costs, including supportive documentation.

Deliverables must be received and accepted in writing by the FDOT State Safety Office prior to payments.

The Subrecipient or its Implementing Agency should submit financial reimbursement forms to the FDOT State Safety Office at least once each quarter as costs are incurred and payment is made. The only exception is when no costs are incurred during a quarter. At a minimum, reimbursement for subgrants with personnel costs should be made after every two pay periods if paid bi-weekly. Reimbursement of personnel costs should be requested monthly if payroll is on a monthly basis. Failure to submit reimbursement requests in a timely manner may result in the subgrant being terminated.

ALL requests for reimbursement shall include FDOT Form 500-065-019 Performance Report for the period of reimbursement.

All requests for reimbursement of Operating Capital Outlay Items having a unit cost of \$5,000 or more and a useful life of one year or more shall be accompanied by a Non-Expendable Property Accountability Record (FDOT Form No. 500-065-09). Reimbursement of Operating Capital Outlay costs shall not be made before receipt of this form.

All requests for reimbursement shall be signed by an Authorized Representative of the Subrecipient or the Administrator of the Implementing Agency, or their delegate.

A final financial request for reimbursement shall be submitted and/or postmarked no later than October 31 following the end of the subgrant period. Such request should be distinctly identified as Final. Failure to submit the invoice in a timely manner shall result in denial of reimbursement. The Subrecipient agrees to forfeit reimbursement of any amount incurred if the final request is not submitted and/or postmarked by October 31 following the end of the subgrant period.

Subrecipients providing goods and services to the Department should be aware of the following time frames. The FDOT State Safety Office has a 30-day review process to approve goods and services that starts on the date of receipt of financial reimbursement request. After that review and approval, the Department has 20 days to deliver a request for payment (voucher) to the Department of Financial Services. The 20 days are measured from the latter of the date the invoice is received or the goods or services are received, inspected, and approved. Financial reimbursement requests may be returned if not completed properly. If a payment is not available within 40 days from the FDOT State Safety Office approval, a separate interest penalty at a rate as established pursuant to Section 55.03(1), F.S., will be due and payable, in addition to the financial reimbursement request amount, to the Subrecipient. Interest penalties of less than one (1) dollar will not be enforced unless the Subrecipient requests payment. Financial reimbursement requests that have to be returned to a Subrecipient because of Subrecipient preparation errors will result in a delay in the payment. The financial reimbursement request payment requirements do not start until a properly completed financial reimbursement request is provided to the Department.

Reimbursement shall be made only after receipt and approval of goods and services. If the Department determines that the performance of the Subrecipient is unsatisfactory, the Department shall notify the Subrecipient of the deficiency to be corrected, which correction shall be made within a time-frame to be specified by the Department. The Subrecipient shall, within five days after notice from the Department, provide the Department with a corrective action plan describing how the Subrecipient will address all issues of subgrant non-performance, unacceptable performance, failure to meet the minimum performance levels, deliverable deficiencies, or subgrant non-compliance. If the corrective action plan is unacceptable to the Department, the Subrecipient shall be assessed a non-performance retainage equivalent to 10% of the total financial reimbursement request. The retainage shall be applied to the financial reimbursement request for the then current billing period. The retainage shall be withheld until the Subrecipient resolves the deficiency. If the deficiency is subsequently resolved, the Subrecipient may bill the Department for the retained amount during the next billing period. If the Subrecipient is unable to resolve the deficiency, the funds retained will be forfeited at the end of the Agreement's term.

A Vendor Ombudsman has been established within the Department of Financial Services. The duties of this individual include acting as an advocate for Subrecipients who may be experiencing problems in obtaining timely payment(s) from a state agency. The Vendor Ombudsman may be contacted at (850) 413-5516 or by calling the Division of Consumer Services at 1-877-693-5236.

17. Ownership of Data and Creative Material. The ownership of material, discoveries, inventions and results developed, produced, or discovered by the agreement are governed by the terms of 2 CFR, Section 200.315, Intangible property, herein incorporated by reference.

18. Property Accountability. The Subrecipient or its implementing agency shall establish and administer a system to control, protect, preserve, use, and maintain and dispose of any property furnished by the Department, or purchased pursuant to this agreement in accordance with Federal Property Management Standards as set forth in 49 CFR, Section 18.32, 49 CFR 19, Section 19.34, or OMB Circular A-110, herein incorporated by reference. This obligation continues as long as the property is retained by the Subrecipient or its implementing agency, notwithstanding the ending of this agreement.

19. Disputes and Appeals. Any dispute, disagreement, or question of fact arising under the agreement may be addressed to the Traffic Safety Administrator of the FDOT State Safety Office in writing. The Traffic Safety Administrator's decision may be appealed in writing within 30 calendar days from the notification to the Governor's Highway Safety Representative, whose decision is final. Addresses are:

Florida Department of Transportation
Attn: Traffic Safety Administrator
State Safety Office, MS 53
605 Suwannee Street
Tallahassee, Florida 32399-0450

Florida Department of Transportation
Attn: Governor's Highway Safety Representative
State Safety Office, MS 53
605 Suwannee Street
Tallahassee, Florida 32399-0450

The Subrecipient and its implementing agency shall proceed diligently with the performance of the agreement and in accordance with Department's decision(s).

20. Conferences and Inspection of Work. Conferences may be held at the request of any party to this agreement. Representatives of the Department or the U.S. Department of Transportation (USDOT), or both, shall be privileged to visit the site for the purpose of inspection and assessment of work being performed at any time.

21. Publication and Printing of Observational Surveys and Other Reports.

- (a) During the subgrant period, but before publication or printing, the final draft of any report or reports required under the agreement or pertaining to the agreement shall be submitted to the FDOT State Safety Office for review and concurrence. After the subgrant period has concluded, Subrecipients may publish after providing the FDOT State Safety Office with at least a 15 day prior written notice.
- (b) Both written and oral releases are considered to be within the context of publication. However, there is no intention to limit discussion of the study with small technical groups or lectures to employees or students. Lectures that describe plans but discuss neither data nor results may be given to other groups without advance approval.

(c) Each publication or other printed report covered by Paragraph 21(a) above shall include the following statement on the cover page:

- (1) This report was prepared for the FDOT State Safety Office, Department of Transportation, State of Florida, in cooperation with the National Highway Traffic Safety Administration, U.S. Department of Transportation and/or Federal Highway Administration, U.S. Department of Transportation.
- (2) The conclusions and opinions expressed in these reports are those of the Subrecipient and do not necessarily represent those of the FDOT State Safety Office, Department of Transportation, State of Florida, and/or the National Highway Traffic Safety Administration, U.S. Department of Transportation and/or Federal Highway Administration, U.S. Department of Transportation, or any other agency of the State or Federal Government.

22. Equal Employment Opportunity. No person shall, on the grounds of race, color, religion, sex, handicap, or national origin, be excluded from participation in, be refused the benefits of, or be otherwise subjected to discrimination under this subgrant, or any project, program, or activity that receives or benefits from this subgrant award. The Subrecipient and its implementing agency agree to comply with Executive Order (E.O.) 11246, as amended by E.O. 11375, and as supplemented by 41 CFR, Part 60, herein incorporated by reference.

23. Responsibility for Claims and Liability. Subject to the limitations of Section 768.28, Florida Statutes, the Subrecipient and its implementing agency shall be required to defend, hold harmless and indemnify the Department, NHTSA, FHWA, and USDOT, from all claims and liability, or both, due to negligence, recklessness, or intentional wrongful misconduct of Subrecipient, implementing agency, and its contractor, consultant, agents and employees. The Subrecipient and its implementing agency shall be liable for any loss of, or damage to, any material purchased or developed under this subgrant agreement which is caused by the Subrecipient's or its implementing agency's failure to exercise such care in regard to said material as a reasonable careful owner of similar materials would exercise.

The parties executing this agreement specifically agree that no provision in this agreement is intended to create in the public or any member thereof, a third party beneficiary, or to authorize anyone not a party to this agreement to maintain a suit for personal injuries or property damage pursuant to the terms or provisions of this agreement.

24. Disadvantaged Business Enterprises (DBE).

(a) The Subrecipient and its implementing agency agree to the following assurance:

The Subrecipient and its implementing agency shall not discriminate on the basis of race, color, national origin, or sex in the award and performance of any USDOT-assisted contract or in the administration of its DBE program required by 49 CFR, Part 26, herein incorporated by reference. The Subrecipient shall take all necessary and reasonable steps under 49 CFR, Part 26 to ensure nondiscrimination in the award and administration of USDOT-assisted contracts. Implementation of this program is a legal obligation and failure to carry out its terms shall be treated as a violation of this agreement. Upon notification to the Subrecipient of its failure to carry out its approved program, the USDOT may impose sanctions as provided for under Part 26 and may, in appropriate cases, refer the matter for enforcement under 18 U.S.C. 1001 and/or the Program Fraud Civil Remedies Act of 1986 (31 U.S.C. 3801 et seq.), herein incorporated by reference.

(b) The Subrecipient and its implementing agency agree to include the following assurance in each contract with a consultant or contractor and to require the consultant or contractor to include this assurance in all subcontract agreements:

The consultant or contractor and subconsultant or subcontractor shall not discriminate on the basis of race, color, national origin, or sex in the performance of this contract. The consultant or contractor shall carry out applicable requirements of 49 CFR, Part 26 in the award and administration of USDOT-assisted contracts. Failure by the consultant or contractor to carry out these requirements is a material breach of this contract, which may result in the termination of this contract or such other remedy, as the Subrecipient, its implementing agency, or the Department deems appropriate.

25. Restrictions on Lobbying. The Subrecipient and its implementing agency agree to comply and require consultants and contractors to comply with 49 CFR, Part 20, New Restrictions on Lobbying, herein incorporated by reference, for filing of certification and disclosure forms.

No funds subgranted hereunder shall be used for the purpose of lobbying the legislature, judicial branch, or state agencies. Section 216.347, Florida Statutes.

26. How Agreement is Affected by Provisions Being Held Invalid. If any provision of this agreement is held invalid, the remainder of this agreement shall not be affected. In such an instance the remainder would then continue to conform to the terms and requirements of applicable law.

27. Federal Requirement for Public Service Announcements, Marketing, and Advertisements. All public service announcements produced with Federal Highway Safety funds shall be closed captioned for the hearing impaired.

Public Service Announcements, Marketing, and Advertising. All paid media reimbursed with subgrant funds shall contain a traffic safety message. In order to maximize the effectiveness of the paid media, when marketing or advertising is included in subgrant activities, it shall be done only in conjunction with proven, effective countermeasures, and when the message of the media is designed to call attention to those countermeasures. Before incurring costs related to the paid media, a final draft of the media and media plan shall be submitted to the FDOT State Safety Office for review.

Media plans should include the following:

- (a) What program/policy the paid media is supporting
- (b) How the paid media will be implemented to support an operational enforcement program whether it be a periodic crackdown/mobilization or an on-going saturation or roving patrol
- (c) The amount allocated for paid media
- (d) Anticipated creative costs associated with the paid media
- (e) The measures that will be used to assess message recognition and penetration of the target audience.

The FDOT State Safety Office shall provide written approval for reimbursement if the paid media is appropriate for purchase under this agreement. Proof of performance (e.g., copies and/or images of posters, air schedules, etc.) of all paid media purchased with highway safety funds shall be attached to reimbursement requests.

All subgrant funded public service announcements, marketing, and advertisements shall be tagged "Funding provided by the Florida Department of Transportation, or Funded by FDOT". The name of the Subrecipient or Implementing agency and its logo can appear on the paid media but the names of individuals connected with the Subrecipient shall not appear when paid for with Federal highway safety funds.

Contractual agreements for marketing and advertising which include communications, public information, and paid media expenditures shall not include gifts as defined by §112.312, Florida Statutes, which includes items such as tickets, seats, food, travel, apparel, memorabilia, etc., to any representative of this agreement or any of their traffic safety partners unless the item or service is regularly made available to the general public at no cost.

28. Public Information and Education Items. Public Information and Education Items are defined as materials whose purpose is to convey substantive information about highway safety. Paper, pamphlets, flash drives, CD-ROMs, and similar media that contain educational materials all allowable because their purpose is to contain and convey educational information. In order to be considered educational, distributed material must provide substantial information and education content to the public (not merely a slogan) and have the sole purpose of conveying that information. If a Subrecipient chooses to provide educational content on a flash drive, CD-ROM, or similar device, that device must be an economical method of conveying the information.

Before printing or ordering any public information and education items, a final draft or drawing of the items shall be submitted to the FDOT State Safety Office for review and approval.

Requests should include the following:

- (a) What public information or educational item is being requested
- (b) What program/policy is the item supporting
- (c) Who the target audience is
- (d) How the item will be distributed
- (e) Estimated unit cost(s) for the item

The FDOT State Safety Office shall provide written approval for reimbursement if the items are appropriate for purchase under this agreement. Copies and/or images of all public information and education items purchased with highway safety funds shall be attached to the forms requesting reimbursement for the items.

Printed materials (tip cards, brochures, safety pledges, surveys, activity books, booklets, guides, etc.) can be freely distributed, however tangible items (helmets, DVDs, CD-ROMs, flash or thumb drives, reflective tape, etc.) require the person receiving the item to interact with the subrecipient in some manner related to the goal of the project in order to receive the item. Interaction includes attending a presentation, signing a pledge sheet, filling out a survey form, answering a traffic safety question, etc. The results of this interaction must be reported in the performance report.

Where feasible, either the Florida Department of Transportation logo or the words "Funding provided by the Florida Department of Transportation, or Funded by FDOT." shall appear on or in all items. The name of the Subrecipient or implementing agency and its logo can appear on any of the public information and education items. The names of individuals connected with the Subrecipient shall not appear on any printed materials, and advertisements paid for with highway safety funds.

Per 2 CFR 200 and NHTSA Memo "Use of NHTSA Highway Safety Grant Funds for Certain Purchases" (dated May 18, 2016), Use of NHTSA grant funds to purchase promotional items or memorabilia is prohibited and therefore unallowable under this subgrant.

29. Term of Agreement. Each subgrant shall begin on the date the last party signs the agreement and shall end on September 30, following, unless otherwise stipulated by the FDOT State Safety Office on the first page of the respective agreement. In the event this subgrant is for services in excess of \$25,000.00 and a term for a period of more than 1 year, the provisions of *Section 339.135(6)(a), F.S.*, are hereby incorporated:

"The Department, during any fiscal year, shall not expend money, incur any liability, or enter into any contract which, by its terms, involves the expenditure of money in excess of the amounts budgeted as available for expenditure during such fiscal year. Any contract, verbal or written, made in violation of this subsection is null and void, and no money may be paid on such contract. The Department shall require a statement from the Comptroller of the Department that such funds are available prior to entering into any such contract or other binding commitment of funds. Nothing herein contained shall prevent the making of contracts for periods exceeding 1 year, but any contract so made shall be executory only for the value of the services to be rendered or agreed to be paid for in succeeding fiscal years; and this paragraph shall be incorporated verbatim in all contracts of the Department which are for an amount in excess of \$25,000.00 and which have a term for a period of more than 1 year."

30. Clean Air Act and Federal Water Pollution Control Act. For subgrant awards in excess of \$100,000 the Subrecipient and its Implementing agency agree to comply with all applicable standards, orders, or regulations issued pursuant to the Clean Air Act (42 U.S.C. 7401 et seq.) and the Federal Water Pollution Control Act (33 U.S.C. 1251 et seq.), herein incorporated by reference. The Subrecipient shall include this provision in all subcontract awards in excess of \$100,000.

31. Personnel Hired Under Agreement. The head of any implementing agency receiving first year funding for a new position(s) through a subgrant shall provide written notification within 30 days of the agreement being awarded to the FDOT State Safety Office that a new position(s) has been created in the agency as a result of the subgrant being awarded. Positions created with subgrant funding shall continue to be funded by the Subrecipient after federal funding ends in order to be eligible for future subgrant funding.

Any and all employees of the Subrecipient or implementing agency whose positions are funded, in whole or in part through a subgrant, shall be the employee of the Subrecipient or implementing agency only, and any and all claims that

may arise from said employment relationship shall be the sole obligation and responsibility of the Subrecipient or its implementing agency.

Personnel funded under the subgrant shall not hold the position of Project Director nor receive any benefit under the grant.

The FDOT State Safety Office must pre-approve the advertisement, hire/replacement, and salary for any full time subgrant funded positions (excluding law enforcement positions).

The FDOT State Safety Office reserves the right to require activity reports to demonstrate that personnel hired under the agreement or equipment purchased with subgrant funds meet the requirements as specified by the subgrant.

32. Overtime. Overtime hours are intended for enhanced/increased traffic safety enforcement. The overtime pay rate for officers is based on actual cost per employee in accordance with the Subrecipient's payroll policy. Each Subrecipient shall comply with Fair Labor Standards Act (FLSA) requirements and thresholds for overtime accrual and payment and its own policies and procedures, insofar as those policies apply uniformly to both federally-financed and other activities of the subrecipient, as required by 2 CFR 200.403(c). Additional enforcement may be called overtime, off duty, extra, additional, etc., as long as it enhances/increases traffic safety enforcement. A copy of the policy shall be maintained by the Subrecipient and/or implementing agency and made available for review if requested.

33. Repossession of Equipment. Ownership of all equipment purchased with Federal highway safety funds rests with the Subrecipient and its implementing agency; however, the USDOT maintains an interest in the equipment and title vests in the Subrecipient subject to several conditions and obligations under 2 CFR Section 200.313. The Subrecipient must use the equipment for the authorized purposes of the project, whether or not the project continues to be supported by the Federal award, unless the FDOT State Safety Office, on behalf of USDOT, provides written authorization for another use of the equipment that is permissible under 2 CFR Section 200.313. Any equipment purchased with Federal highway safety funds that is not being used by the Subrecipient or its implementing agency for the purposes described in the project or in accordance with other authorized uses under 2 CFR Section 200.313, is subject to repossession by the FDOT State Safety Office, on behalf of the USDOT. Items that are repossessed shall be disbursed to agencies that agree to use the equipment for the activity described in this project or for other uses authorized by USDOT.

34. Replacement or Repair of Equipment. The Subrecipient and its implementing agency are responsible, at their own cost, for replacing or repairing any equipment purchased with Federal highway safety funds that is damaged, stolen, or lost, or that wears out as a result of misuse. The FDOT State Safety Office retains the right to replace or repair any equipment for statewide programs based on exceptional individual circumstances.

35. Ineligibility for Future Funding. The Subrecipient and its implementing agency agree that the Department shall find the Subrecipient or its implementing agency ineligible for future funding for any of the following reasons:

- (a) Failure to provide the required audits,
- (b) Failure to continue funding positions created with highway safety funds after the Federal funding cycle ends,
- (c) Failure to provide required performance and final narrative reports in the required time frame,
- (d) Failure to perform work described in Part II of the subgrant agreement,
- (e) Providing fraudulent performance reports or reimbursement requests,
- (f) Misuse of equipment purchased with Federal highway safety funds.

36. Safety Belt Policy. Each Subrecipient and implementing agency shall have a written safety belt policy, which is enforced for all employees. A copy of the policy shall be maintained by the Subrecipient and/or implementing agency and made available for review if requested.

37. Occupant Protection. All law enforcement agencies receiving subgrant funds for occupant protection education or enforcement shall have a standard operating procedure regarding enforcement of safety belt and child safety seat violations. A copy of the procedure shall be maintained by the Subrecipient and/or implementing agency and made available for review if requested.

38. Equipment. Any equipment purchased under this subgrant with highway safety funds shall not replace previously purchased equipment that is damaged, stolen, lost, or that wears out as a result of misuse, whether the equipment was purchased with federal, state, or local funds.

39. Vehicles. Any agency receiving subgrant funds to purchase a vehicle (excluding law enforcement vehicles) shall maintain a travel log that contains the beginning and ending mileage, location, and purpose of travel. All agencies must report any vehicle use (excluding law enforcement vehicles) and maintenance with each request for reimbursement using the Safety Grant Vehicle Use Form (FDOT Form No. 500-065-21) and the Safety Grant Equipment Maintenance Form (FDOT Form No. 500-065-22).

Vehicles purchased with federal highway safety funds shall be used for program use only and in accordance with Chapter 60B-1.004 Florida Statutes. Subrecipients who are responsible for the operation and use vehicles for official state business are allowed to permit persons other than state officials or employees to travel in the vehicle provided these persons are conducting official state business or only on special occasions if the purpose of the travel can be more usefully served by including such persons and no additional expense is involved.

It is permissible to transport persons other than state officials and employees during disasters and emergency situations where the state must protect life and property. Providing assistance to motorists whose vehicles are disabled may be considered as an emergency when there is a need to protect life and property.

Any vehicles used for personal reasons or not being used by the Subrecipient or its implementing agency for the purposes described in the subgrant shall be subject to repossession by the FDOT State Safety Office.

40. Child Safety Seats. Any implementing agency that receives funds to purchase child safety seats must have at least one staff member who is a current Certified Child Passenger Safety Technician. Failure to comply with this provision shall result in the termination of this agreement.

41. Buy America Act. The Subrecipient and its implementing agency agree to comply and require consultants and contractors to comply with all applicable standards, orders, and regulations issued pursuant to the Buy America Act (23 U.S.C. 313 et seq) herein incorporated by reference. The Subrecipient shall include the following Buy America provisions in all subcontract awards:

The Buy America Act prohibits the use of Federal highway safety grant funds to purchase any manufactured product or software/information technology systems whose unit purchase price is \$5,000 or more, including a motor vehicle, that is not produced in the United States. NHTSA may waive those requirements if (1) their application would be inconsistent with the public interest; (2) such materials and products are not produced in the United States in sufficient and reasonably available quantities and of a satisfactory quality; or (3) the inclusion of domestic material will increase the cost of the overall project contract by more than 25 percent.

Each manufactured end product must comply with the provisions of the Buy America Act. Additionally, any manufactured add-on to an end product is, itself, an end product that must comply with the Act.

To be reimbursed with Federal highway safety grant funds for a purchase, a State must comply with the requirements of the Buy America Act. Non-compliance will result in denial of reimbursement.

42. E-Verify. Subrecipients:

- (a) shall utilize the U.S. Department of Homeland Security's E-Verify system to verify the employment eligibility of all new employees hired by the Vendor/Contractor during the term of the contract; and
- (b) shall expressly require any subcontractors performing work or providing services pursuant to the state contract to likewise utilize the U.S. Department of Homeland Security's E-Verify system to verify the employment eligibility of all new employees hired by the subcontractor during the contract term.

43. Program Income. Program income means gross income earned by Subrecipient that is directly generated by a supported activity or earned as a result of the subgrant award during the subgrant period of performance. Program

income must be deducted from total allowable costs to determine the net allowable costs. Program income must be used for current costs and any remaining program income must be offset against the final request for reimbursement. Program income that the Subrecipient did not anticipate at the time of the subgrant award must be used to reduce the Federal award and Subrecipient contributions rather than to increase the funds committed to the project.

44. Indirect Costs. If a Subrecipient has a federally negotiated Indirect cost rate, it may be applied to the subgrant. If a Subrecipient does not have a federally negotiated indirect cost rate, a rate up to the de minimis indirect cost rate of 10% of modified total direct costs may be applied. A Subrecipient may opt to request a lower or no indirect costs rate, even if it has a federally negotiated indirect cost rate. The FDOT State Safety Office will not coerce or negotiate with a Subrecipient to reduce its Indirect costs rate for this subgrant, per federal regulation. Subgrants with indirect costs will be awarded based on cost benefit and available funding.

45. Impaired Driving Enforcement, Training and Reporting. Any law enforcement officer who takes enforcement action and receives compensation under an impaired driving subgrant must have successfully completed at least one of the following within the last five years:

- (a) NHTSA/IACP 24 hour DWI Detection and Standardized Field Sobriety Testing (SFST) course
- (b) NHTSA/IACP 4 hour DWI Detection and Standardized Field Sobriety Testing (SFST) refresher course
- (c) NHTSA/IACP DWI Detection and Standardized Field Sobriety Testing (SFST) Instructor Development course
- (d) NHTSA/IACP 8 hour DWI Detection and Standardized Field Sobriety Testing (SFST) Instructor Update course
- (e) NHTSA/IACP Advanced Roadside Impaired Driving Enforcement (ARIDE) course
- (f) Be an active certified Drug Recognition Expert (DRE)

The FDOT State Safety Office reserves the right to request a copy of any subgrant funded checkpoint After Action Report.

All law enforcement agencies that receive impaired driving subgrant funding should participate in all NHTSA impaired driving mobilizations for the following holidays and events: New Year's Day, NFL Super Bowl, St. Patrick's Day, Cinco de Mayo, Independence Day, Labor Day, and Halloween.

All law enforcement agencies shall conduct High Visibility Enforcement of impaired drivers while conducting enforcement under the subgrant.

High Visibility Enforcement is:

- Intense: Enforcement activities are over and above what normally takes place.
- Frequent: Enforcement occurs often enough to create general deterrence.
- Visible: A majority of the public sees or hears about the enforcement.
- Strategic: Enforcement targets high-risk locations during high-risk times.

A strong emphasis of enforcement operations should be during the hours of 6:00pm to 6:00am. Agencies should ensure that enforcement saturation/wolfpack/roving patrols are conducted in periods of no fewer than 3 consecutive hours.

Use of subgrant funding will not be utilized or reimbursed for continuing priority initiated investigations, court or Administrative Hearings, and enforcement from aircraft.

46. Nondiscrimination. Subrecipients will comply with all Federal statutes and implementing regulations relating to nondiscrimination ("Federal Nondiscrimination Authorities"). These include but are not limited to:

- (a) Title VI of the Civil Rights Act of 1964 (42 U.S.C. 2000d *et seq.*, 78 stat. 252), (prohibits discrimination on the basis of race, color, national origin) and 49 CFR part 21
- (b) The Uniform Relocation Assistance and Real Property Acquisition Policies Act of 1970, (42 U.S.C. 4601), (prohibits unfair treatment of persons displaced or whose property has been acquired because of Federal or Federal-aid programs and projects)

- (c) Federal-Aid Highway Act of 1973, (23 U.S.C. 324 et seq.), and Title IX of the Education Amendments of 1972, as amended (20 U.S.C. 1681–1683 and 1685–1686) (prohibit discrimination on the basis of sex)
- (d) Section 504 of the Rehabilitation Act of 1973, (29 U.S.C. 794 et seq.), as amended, (prohibits discrimination on the basis of disability) and 49 CFR part 27
- (e) The Age Discrimination Act of 1975, as amended, (42 U.S.C. 6101 et seq.), (prohibits discrimination on the basis of age)
- (f) The Civil Rights Restoration Act of 1987, (Pub. L. 100–209), (broadens scope, coverage and applicability of Title VI of the Civil Rights Act of 1964, The Age Discrimination Act of 1975 and Section 504 of the Rehabilitation Act of 1973, by expanding the definition of the terms "programs or activities" to include all of the programs or activities of the Federal aid recipients, Subrecipient's and contractors, whether such programs or activities are Federally-funded or not)
- (g) Titles II and III of the Americans with Disabilities Act (42 U.S.C. 12131–12189) (prohibits discrimination on the basis of disability in the operation of public entities, public and private transportation systems, places of public accommodation, and certain testing) and 49 CFR parts 37 and 38;
- (h) Executive Order 12898, Federal Actions To Address Environmental Justice in Minority Populations and Low-Income Populations (prevents discrimination against minority populations by discouraging programs, policies, and activities with disproportionately high and adverse human health or environmental effects on minority and low-income populations); and
- (i) Executive Order 13166, Improving Access to Services for Persons with Limited English Proficiency (guards against Title VI national origin discrimination/discrimination because of limited English proficiency (LEP) by ensuring that funding recipients take reasonable steps to ensure that LEP persons have meaningful access to programs (70 FR 74087–74100).

During the performance of this subgrant, the Subrecipient agrees:

- (a) To comply with all Federal nondiscrimination laws and regulations, as may be amended from time to time
- (b) Not to participate directly or indirectly in the discrimination prohibited by any Federal non-discrimination law or regulation, as set forth in appendix B of 49 CFR part 21 and herein
- (c) To permit access to its books, records, accounts, other sources of information, and its facilities as required by the FDOT State Safety Office, US DOT or NHTSA
- (d) That, in event a Subrecipient fails to comply with any nondiscrimination provisions in this subgrant, the FDOT State Safety Office will have the right to impose such subgrant sanctions as it or NHTSA determine are appropriate, including but not limited to withholding payments to the Subrecipient under the contract/agreement until the Subrecipient complies; and/or cancelling, terminating, or suspending a contract or funding agreement, in whole or in part
- (e) To insert this clause, including paragraphs a through e, in every subcontract and sub-agreement and in every solicitation for a subcontract or sub-agreement, which receives Federal funds under this program

Political Activity. The Subrecipient will comply with provisions of the Hatch Act (5 U.S.C. 1501–1508), which limits the political activities of employees whose principal employment activities are funded in whole or in part with Federal funds.

Certification Regarding Federal Lobbying. The Subrecipient certifies, to the best of his or her knowledge and belief, that:

- (a) No Federal appropriated funds have been paid or will be paid, by or on behalf of the undersigned, to any person for influencing or attempting to influence an officer or employee of any agency, a Member of Congress, an officer or employee of Congress, or an employee of a Member of Congress in connection with the awarding of any Federal contract, the making of any Federal grant, the making of any Federal loan, the entering into of any cooperative agreement, and the extension, continuation, renewal, amendment, or modification of any Federal contract, grant, loan, or cooperative agreement.
- (b) If any funds other than Federal appropriated funds have been paid or will be paid to any person for influencing or attempting to influence an officer or employee of any agency, a Member of Congress, an officer or employee of Congress, or an employee of a Member of Congress in connection with this Federal contract, grant, loan, or cooperative agreement, the undersigned shall complete and submit Standard Form-LLL, "Disclosure Form to Report Lobbying," in accordance with its instructions.
- (c) The Subrecipient shall require that the language of this certification be included in the award documents for all sub-award at all tiers (including subcontracts, subgrants, and contracts under grant, loans, and cooperative agreements) and that all Subrecipients shall certify and disclose accordingly.

This certification is a material representation of fact upon which reliance was placed when this transaction was made or entered into. Submission of this certification is a prerequisite for making or entering into this transaction imposed by section 1352, title 31, U.S. Code. Any person who fails to file the required certification shall be subject to a civil penalty of not less than \$10,000 and not more than \$100,000 for each such failure.

47. Restriction on State Lobbying. None of the funds under this program will be used for any activity specifically designed to urge or influence a State or local legislator to favor or oppose the adoption of any specific legislative proposal pending before any State or local legislative body. Such activities include both direct and indirect (e.g., "grassroots") lobbying activities, with one exception. This does not preclude a State official whose salary is supported with NHTSA funds from engaging in direct communications with State or local legislative officials, in accordance with customary State practice, even if such communications urge legislative officials to favor or oppose the adoption of a specific pending legislative proposal.

48. Registration for attendance: No activities funded under this subgrant shall charge a registration fee for attendance.

49. Special Conditions.

Part VI: Federal Financial Assistance (Single Audit Act)

Federal resources awarded pursuant to this subgrant are as follows:

CFDA Number and Title:

- 20.600 – State and Community Highway Traffic Safety Program (NHTSA 402 Funds)
- 20.611 – Incentive Grant Program to Prohibit Racial Profiling (NHTSA 1906 Funds)
- 20.614 – National Highway Traffic Safety Administration Discretionary Safety Grants (NHTSA 403 funds)
- 20.616 – National Priority Safety Program (NHTSA 405 Funds)

***Federal Funds Awarded:** \$\$50,000.00

Awarding Agency: Florida Department of Transportation

Indirect Cost Rate: NA

****Award Is for R&D:** No

*The federal award amount may change with supplemental agreements

**Research and Development as defined at §200.87, 2 CFR Part 200

Federal resources awarded pursuant to this subgrant are subject to the following audit requirements:

- (a) 2 CFR Part 200 – Uniform Administrative Requirements, Cost Principles and Audit Requirements for Federal Awards
www.ecfr.gov
- (b) OMB Circular A-133, Audits of States, Local Governments and Non-Profit Organizations
www.whitehouse.gov/omb/circulars

Federal resources awarded pursuant to this subgrant may also be subject to the following:

- (a) OMB Circular A-87, *Cost Principles for State, Local and Indian Tribal Governments*
www.whitehouse.gov/omb/circulars
- (b) OMB Circular A-102, *Grants and Cooperative Agreements with State and Local Governments*
www.whitehouse.gov/omb/circulars
- (c) Federal Funding Accountability and Transparency Act (FFATA) Sub-award Reporting System (FSRS)
www.fsrs.gov

Project Title: PCBPD Outreach Program to Fight Against Speed and Aggressive Driving
Project Number: SC-18-13-10
FDOT Contract Number: G0Q03

IN WITNESS WHEREOF, the parties affirm that they have each read and agree to the conditions set forth in Part V of this Agreement that each have read and understand the Agreement in its entirety. Now, therefore, in consideration of the mutual covenants, promises and representations herein have executed this Agreement by their undersigned officials on the day, month, and year set out below.

(For FDOT Use Only)

STATE OF FLORIDA
DEPARTMENT OF TRANSPORTATION

By: Chris Craig
Authorized FDOT State Safety Office Representative

Date: 11/06/17
Date Signed

Reviewed for the Florida Department of Transportation:

By: [Signature]
Authorized FDOT Attorney

Date: 11.3.17
Date Signed

SUBRECIPIENT

City of Panama City Beach
Subrecipient Agency Name

By: [Signature]
Signature of Authorized Representative

Name: Mario Gisbert
Authorized Representative's Name Printed

Title: City Manager
Authorized Representative's Title Printed

Date: 10-30-17
Date Signed

IMPLEMENTING AGENCY

By: [Signature]
Signature of Authorized Representative

Name: Drew R. Whitman
Authorized Representative's Name Printed

Title: Chief of Police
Authorized Representative's Title Printed

Date: 10-27-17
Date Signed

NOTE: These signatures are the only recognized authorized representatives for this agreement, unless delegation is granted in writing.

REGULAR AGENDA

ITEM 7



CITY OF PANAMA CITY BEACH AGENDA ITEM SUMMARY

1. DEPARTMENT MAKING REQUEST/NAME:

ADMINISTRATION

2. MEETING DATE:

DECEMBER 14, 2017

3. REQUESTED MOTION/ACTION:

APPOINT CITY TREASURER BY RESOLUTION

4. AGENDA

PRESENTATION
PUBLIC HEARING
CONSENT
REGULAR

5. IS THIS ITEM BUDGETED (IF APPLICABLE)? YES NO
BUDGET AMENDMENT OR N/A

N/A

DETAILED BUDGET AMENDMENT ATTACHED YES NO

N/A

6. BACKGROUND: (WHY IS THE ACTION NECESSARY, WHAT GOAL WILL BE ACHIEVED)

CITY CODE SECTION 2-667 PROVIDES THAT THE CITY COUNCIL SHALL APPOINT THE CITY TREASURER BY RESOLUTION.

COUNCILWOMAN STRANGE IS THE CURRENTLY APPOINTED CITY TREASURER, WHOSE TERM AS COUNCILPERSON EXPIRES IN APRIL. IN ORDER TO AVOID ANY INTERRUPTION IN ADMINISTRATION OF THE CITY'S FINANCES WHICH REQUIRE THE SIGNATURE OF THE CITY TREASURER, STAFF REQUESTS THE CITY COUNCIL APPOINT A NEW TREASURER SO THAT NEW SIGNATURE CARDS AND SIGNATURE PLATES CAN BE PREPARED BEFORE THE APRIL ELECTION.

RESOLUTION 18-23

A RESOLUTION OF THE CITY OF PANAMA CITY BEACH, FLORIDA,
APPOINTING _____ AS THE CITY TREASURER.

WHEREAS, Section 2-667 of the City's Code of Ordinances provides that the City
Treasurer shall be appointed by Resolution of the City Council; and

WHEREAS, Councilwoman Strange is the currently appointed City Treasurer; and

WHEREAS, Councilwoman Strange's second term as Councilperson is set to expire in
April, 2018; and

WHEREAS, Staff requests a successor City Treasurer be appointed so that banking
documents and signature plates can be prepared naming that successor to ensure there is no
interruption in the administration of the City's finances.

NOW THEREFORE BE IT RESOLVED by the City of Panama City Beach, Florida that:

1. _____ is appointed as City Treasurer for the City of Panama City
Beach, Florida, and the appropriate officers of the City are directed to take all necessary actions
to update any instruments in order to properly implement this designation.
2. This Resolution shall take effect immediately upon passage.

PASSED, APPROVED AND ADOPTED at the regular meeting of the City Council of
the City of Panama City Beach, Florida, this ____ day of _____, 201__.

CITY OF PANAMA CITY BEACH

By: _____
Mike Thomas, Mayor

ATTEST:

Jo Smith, City Clerk

AGENDA ITEM # _____



REGULAR AGENDA

ITEM 8



CITY OF PANAMA CITY BEACH AGENDA ITEM SUMMARY

1. DEPARTMENT MAKING REQUEST/NAME:

Public Works/Kelly Jenkins

2. MEETING DATE:

12/14/2017

3. REQUESTED MOTION/ACTION:

Approve Budget Amendment for the Federally Funded Subaward and Grant Agreement Phase II - Gulf Highlands

4. AGENDA

PRESENTATION

PUBLIC HEARING

CONSENT

REGULAR

5. IS THIS ITEM BUDGETED (IF APPLICABLE)? YES NO N/A
BUDGET AMENDMENT OR N/A

DETAILED BUDGET AMENDMENT ATTACHED YES NO N/A

6. BACKGROUND: (WHY IS THE ACTION NECESSARY, WHAT GOAL WILL BE ACHIEVED)

In 2015 the City received the award for Phase 1 of the FEMA Hazard Mitigation Grant Program (HMGP) for the Gulf Highlands Drainage Improvement project. That award funded the design, construction plans and permitting for this project. Phase 2 of the grant was then submitted to the State for review and approval of the construction of this project. Staff is in receipt of the Phase 2 HMGP award in the amount of \$518,425.00 to help fund the Gulf Highlands Drainage Improvement Project. These grant funds were not included in the original stormwater budget and therefore a budget amendment is attached to accept and include these funds from FEMA.

Staff recommends approval.

RESOLUTION 18-25

A RESOLUTION OF THE CITY OF PANAMA CITY BEACH, FLORIDA; AUTHORIZING THE EXECUTION AND DELIVERY OF THAT CERTAIN HAZARD MITIGATION GRANT AGREEMENT BETWEEN THE CITY AND THE STATE OF FLORIDA, DIVISION OF EMERGENCY MANAGEMENT, RELATED TO CONSTRUCTION OF THE GULF HIGHLANDS DRAINAGE IMPROVEMENT PROJECT IN THE AMOUNT OF \$518,425, APPROVING A BUDGET AMENDMENT RECOGNIZING RECEIPT OF GRANT FUNDS FOR THE PROJECT; AND PROVIDING AN IMMEDIATELY EFFECTIVE DATE.

WHEREAS, on February 19, 2015 the Federally-Funded Subgrant Agreement was executed between the City and the State of Florida, Division of Emergency Management, for Phase I, the design of Gulf Highlands Mitigation Project; and

WHEREAS, on April 22, 2015 the Modification to Subgrant Agreement was executed between the City and the State of Florida, Division of Emergency Management, for Phase I; and

WHEREAS, the City applied for a grant from the State of Florida for Phase II, the construction of the Gulf Highlands Drainage Improvement Project; and

WHEREAS, a grant was awarded by the State to the City and the State has proffered that certain Federally-Funded Subaward and Grant Agreement between the City and the State of Florida, Division of Emergency Management, relating to award and use of grant money for Phase II of Gulf Highlands Mitigation Project; and

WHEREAS, the Project was included in the FY 2018 stormwater budget; however, a budget amendment is necessary to reflect the total revenue of \$518,425 to be received from the grant and the expenditure of those funds for the Project.

NOW THEREFORE BE IT RESOLVED by the City Council of the City of Panama City Beach, that:

1. The appropriate officers of the City are authorized but not required to execute and deliver on behalf of the City that certain Hazard Mitigation Grant

Resolution 18-25

AGENDA ITEM # 8

Agreement between the City and the State of Florida, Division of Emergency Management, relating to award and use of grant money for Phase II of Gulf Highlands Drainage Improvement Project, in the basic amount of Five Hundred Eighteen Thousand, Four Hundred Twenty Five Dollars (\$518,425.00), in substantially the form attached, incorporated and marked as Exhibit A, with such changes, insertions or omissions as may be approved by the City Manager, whose execution of such agreement shall be conclusive evidence of such approval.

2. The following budget amendment #4 is adopted for the City of Panama City Beach, Florida, for the fiscal year beginning October 1, 2017, and ending September 30, 2018, as shown in and in accordance with the attached and incorporated Exhibit B.
3. This Resolution shall take effect immediately upon passage.

PASSED, APPROVED AND ADOPTED, at the regular meeting of the City Council of the City of Panama City Beach, Florida this 14th day of December, 2017.

CITY OF PANAMA CITY BEACH

By: _____
Mike Thomas, Mayor

ATTEST:

Jo Smith, City Clerk

Agreement Number: 18HM-9J-01-13-02-XXX

Project Number: 4138-5-A

FEDERALLY-FUNDED SUBAWARD AND GRANT AGREEMENT

2 C.F.R. §200.92 states that a "subaward may be provided through any form of legal agreement, including an agreement that the pass-through entity considers a contract."

As defined by 2 C.F.R. §200.74, "pass-through entity" means "a non-Federal entity that provides a subaward to a Sub-recipient to carry out part of a Federal program."

As defined by 2 C.F.R. §200.93, "Sub-Recipient" means "a non-Federal entity that receives a subaward from a pass-through entity to carry out part of a Federal program."

As defined by 2 C.F.R. §200.38, "Federal award" means "Federal financial assistance that a non-Federal entity receives directly from a Federal awarding agency or indirectly from a pass-through entity."

As defined by 2 C.F.R. §200.92, "subaward" means "an award provided by a pass-through entity to a Sub-Recipient for the Sub-Recipient to carry out part of a Federal award received by the pass-through entity."

The following information is provided pursuant to 2 C.F.R. §200.331(a)(1):

Sub-Recipient's name:	<u>CITY OF PANAMA CITY BEACH</u>
Sub-Recipient's unique entity identifier:	<u>F596045116</u>
Federal Award Identification Number (FAIN):	<u>FEMA-DR-4138-FL</u>
Federal Award Date:	<u>October 27, 2017</u>
Subaward Period of Performance Start and End Date:	<u>Upon Execution thru October 31, 2019</u>
Amount of Federal Funds Obligated by this Agreement:	<u>\$518,425.00</u>
Total Amount of Federal Funds Obligated to the Sub-Recipient by the pass-through entity to include this Agreement:	<u>\$518,425.00</u>
Total Amount of the Federal Award committed to the Sub-Recipient by the pass-through entity	<u>\$518,425.00</u>
Federal award project description (see FFATA):	<u>City of Panama City Beach – Drainage Project</u>
Name of Federal awarding agency:	<u>Federal Emergency Management Agency</u>
Name of pass-through entity:	<u>FL Division of Emergency Management</u>
Contact information for the pass-through entity:	<u>Velma.noel@em.myflorida.com</u>
Catalog of Federal Domestic Assistance (CFDA) Number and Name:	<u>97.039 Hazard Mitigation Program</u>
Whether the award is R&D:	<u>N/A</u>
Indirect cost rate for the Federal award:	<u>N/A</u>

¹
Exhibit A

THIS AGREEMENT is entered into by the State of Florida, Division of Emergency Management, with headquarters in Tallahassee, Florida (hereinafter referred to as the "Division"), and the City of Panama City Beach, (hereinafter referred to as the "Sub-Recipient").

For the purposes of this Agreement, the Division serves as the pass-through entity for a Federal award, and the Sub-Recipient serves as the recipient of a subaward.

THIS AGREEMENT IS ENTERED INTO BASED ON THE FOLLOWING REPRESENTATIONS:

A. The Sub-Recipient represents that it is fully qualified and eligible to receive these grant funds to provide the services identified herein;

B. The State of Florida received these grant funds from the Federal government, and the Division has the authority to subaward these funds to the Sub-Recipient upon the terms and conditions outlined below; and,

C. The Division has statutory authority to disburse the funds under this Agreement.

THEREFORE, the Division and the Sub-Recipient agree to the following:

(1) APPLICATION OF STATE LAW TO THIS AGREEMENT

2 C.F.R. §200.302 provides: "Each state must expend and account for the Federal award in accordance with state laws and procedures for expending and accounting for the state's own funds." Therefore, section 215.971, Florida Statutes, entitled "Agreements funded with federal or state assistance", applies to this Agreement.

(2) LAWS, RULES, REGULATIONS AND POLICIES

a. The Sub-Recipient's performance under this Agreement is subject to 2 C.F.R. Part 200, entitled "Uniform Administrative Requirements, Cost Principles, and Audit Requirements for Federal Awards."

b. As required by Section 215.971(1), Florida Statutes, this Agreement includes:

i. A provision specifying a scope of work that clearly establishes the tasks that the Sub-Recipient is required to perform.

ii. A provision dividing the agreement into quantifiable units of deliverables that must be received and accepted in writing by the Division before payment. Each deliverable must be directly related to the scope of work and specify the required minimum level of service to be performed and the criteria for evaluating the successful completion of each deliverable.

iii. A provision specifying the financial consequences that apply if the Sub-Recipient fails to perform the minimum level of service required by the agreement.

iv. A provision specifying that the Sub-Recipient may expend funds only for allowable costs resulting from obligations incurred during the specified agreement period.

v. A provision specifying that any balance of unobligated funds which has been advanced or paid must be refunded to the Division.

vi. A provision specifying that any funds paid in excess of the amount to which the Sub-Recipient is entitled under the terms and conditions of the agreement must be refunded to the Division.

c. In addition to the foregoing, the Sub-Recipient and the Division shall be governed by all applicable State and Federal laws, rules and regulations, including those identified in Attachment C. Any express reference in this Agreement to a particular statute, rule, or regulation in no way implies that no other statute, rule, or regulation applies.

(3) CONTACT

a. In accordance with section 215.971(2), Florida Statutes, the Division's Grant Manager shall be responsible for enforcing performance of this Agreement's terms and conditions and shall serve as the Division's liaison with the Sub-Recipient. As part of his/her duties, the Grant Manager for the Division shall:

- i. Monitor and document Sub-Recipient performance; and,
- ii. Review and document all deliverables for which the Sub-Recipient requests payment.

b. The Division's Grant Manager for this Agreement is:

Ms. Velma Noel, Project Manager
Bureau of Mitigation
Division of Emergency Management
2702 Directors Row
Orlando, Florida 32809-5631
Telephone: (850) 815-4571
Email: velma.noel@em.myflorida.com

c. The name and address of the Representative of the Sub-Recipient responsible for the administration of this Agreement is:

Ms. Kelly Jenkins, City Engineer
110 S. Arnold Road
Panama City Beach, Florida 32413
Telephone: (850) 233-5100, Ext. 2414
Fax: (850) 223-5010
Email: kjenkins@pcbqov.com

d. In the event that different representatives or addresses are designated by either party after execution of this Agreement, notice of the name, title and address of the new representative will be provided to the other party.

(4) TERMS AND CONDITIONS

This Agreement contains all the terms and conditions agreed upon by the parties.

(5) EXECUTION

This Agreement may be executed in any number of counterparts, any one of which may be taken as an original.

(6) MODIFICATION

Either party may request modification of the provisions of this Agreement. Changes which are agreed upon shall be valid only when in writing, signed by each of the parties, and attached to the original of this Agreement.

(7) SCOPE OF WORK

The Sub-Recipient shall perform the work in accordance with the Budget and Scope of Work, Attachment A of this Agreement.

(8) PERIOD OF AGREEMENT

This Agreement shall begin upon execution by both parties and shall end on October 31, 2019, unless terminated earlier in accordance with the provisions of Paragraph (17) of this Agreement. Consistent with the definition of "period of performance" contained in 2 C.F.R. §200.77, the term "period of agreement" refers to the time during which the Sub-Recipient "may incur new obligations to carry out the work authorized under" this Agreement. In accordance with 2 C.F.R. §200.309, the Sub-Recipient may receive reimbursement under this Agreement only for "allowable costs incurred during the period of performance." In accordance with section 215.971(1)(d), Florida Statutes, the Sub-Recipient may expend funds authorized by this Agreement "only for allowable costs resulting from obligations incurred during" the period of agreement.

(9) FUNDING

- a. This is a cost-reimbursement Agreement, subject to the availability of funds.
- b. The State of Florida's performance and obligation to pay under this Agreement is contingent upon an annual appropriation by the Legislature, and subject to any modification in accordance with either Chapter 216, Florida Statutes, or the Florida Constitution.
- c. The Division will reimburse the Sub-Recipient only for allowable costs incurred by the Sub-Recipient in the successful completion of each deliverable. The maximum reimbursement amount for each deliverable is outlined in Attachment A of this Agreement ("Budget and Scope of Work"). The maximum reimbursement amount for the entirety of this Agreement is \$518,425.00.
- d. As required by 2 C.F.R. §200.415(a), any request for payment under this Agreement must include a certification, signed by an official who is authorized to legally bind the Sub-Recipient, which reads as follows: "By signing this report, I certify to the best of my knowledge and belief that the report is true, complete, and accurate, and the expenditures, disbursements and cash receipts are for the purposes and objectives set forth in the terms and conditions of the Federal award. I am aware that any false, fictitious, or fraudulent information, or the omission of any material fact, may subject me to criminal,

civil or administrative penalties for fraud, false statements, false claims or otherwise. (U.S. Code Title 18, Section 1001 and Title 31, Sections 3729-3730 and 3801-3812)."

e. The Division will review any request for reimbursement by comparing the documentation provided by the Sub-Recipient against a performance measure, outlined in Attachment A, that clearly delineates:

- i. The required minimum acceptable level of service to be performed; and,
- ii. The criteria for evaluating the successful completion of each deliverable.

f. The performance measure required by section 215.971(1)(b), Florida Statutes, remains consistent with the requirement for a "performance goal", which is defined in 2 C.F.R. §200.76 as "a target level of performance expressed as a tangible, measurable objective, against which actual achievement can be compared." It also remains consistent with the requirement, contained in 2 C.F.R. §200.301, that the Division and the Sub-Recipient "relate financial data to performance accomplishments of the Federal award."

g. If authorized by the Federal Awarding Agency, then the Division will reimburse the Sub-Recipient for overtime expenses in accordance with 2 C.F.R. §200.430 ("Compensation—personal services") and 2 C.F.R. §200.431 ("Compensation—fringe benefits"). If the Sub-Recipient seeks reimbursement for overtime expenses for periods when no work is performed due to vacation, holiday, illness, failure of the employer to provide sufficient work, or other similar cause (*see* 29 U.S.C. §207(e)(2)), then the Division will treat the expense as a fringe benefit. 2 C.F.R. §200.431(a) defines fringe benefits as "allowances and services provided by employers to their employees as compensation in addition to regular salaries and wages." Fringe benefits are allowable under this Agreement as long as the benefits are reasonable and are required by law, Sub-Recipient-employee agreement, or an established policy of the Sub-Recipient. 2 C.F.R. §200.431(b) provides that the cost of fringe benefits in the form of regular compensation paid to employees during periods of authorized absences from the job, such as for annual leave, family-related leave, sick leave, holidays, court leave, military leave, administrative leave, and other similar benefits, are allowable if all of the following criteria are met:

- i. They are provided under established written leave policies;
- ii. The costs are equitably allocated to all related activities, including Federal awards; and,

iii. The accounting basis (cash or accrual) selected for costing each type of leave is consistently followed by the non-Federal entity or specified grouping of employees.

h. If authorized by the Federal Awarding Agency, then the Division will reimburse the Sub-Recipient for travel expenses in accordance with 2 C.F.R. §200.474. As required by the Reference Guide for State Expenditures, reimbursement for travel must be in accordance with section 112.061, Florida Statutes, which includes submission of the claim on the approved state travel voucher. If the Sub-Recipient seeks reimbursement for travel costs that exceed the amounts stated in section 112.061(6)(b),

Florida Statutes (\$6 for breakfast, \$11 for lunch, and \$19 for dinner), then the Sub-Recipient must provide documentation that:

- i. The costs are reasonable and do not exceed charges normally allowed by the Sub-Recipient in its regular operations as a result of the Sub-Recipient's written travel policy; and,
 - ii. Participation of the individual in the travel is necessary to the Federal award.
- i. The Division's grant manager, as required by section 215.971(2)(c), Florida Statutes, shall reconcile and verify all funds received against all funds expended during the grant agreement period and produce a final reconciliation report. The final report must identify any funds paid in excess of the expenditures incurred by the Sub-Recipient.
- j. As defined by 2 C.F.R. §200.53, the term "improper payment" means or includes:
- i. Any payment that should not have been made or that was made in an incorrect amount (including overpayments and underpayments) under statutory, contractual, administrative, or other legally applicable requirements; and,
 - ii. Any payment to an ineligible party, any payment for an ineligible good or service, any duplicate payment, any payment for a good or service not received (except for such payments where authorized by law), any payment that does not account for credit for applicable discounts, and any payment where insufficient or lack of documentation prevents a reviewer from discerning whether a payment was proper.

(10)RECORDS

a. As required by 2 C.F.R. §200.336, the Federal awarding agency, Inspectors General, the Comptroller General of the United States, and the Division, or any of their authorized representatives, shall enjoy the right of access to any documents, papers, or other records of the Sub-Recipient which are pertinent to the Federal award, in order to make audits, examinations, excerpts, and transcripts. The right of access also includes timely and reasonable access to the Sub-Recipient's personnel for the purpose of interview and discussion related to such documents. Finally, the right of access is not limited to the required retention period but lasts as long as the records are retained.

b. As required by 2 C.F.R. §200.331(a)(5), the Division, the Chief Inspector General of the State of Florida, the Florida Auditor General, or any of their authorized representatives, shall enjoy the right of access to any documents, financial statements, papers, or other records of the Sub-Recipient which are pertinent to this Agreement, in order to make audits, examinations, excerpts, and transcripts. The right of access also includes timely and reasonable access to the Sub-Recipient's personnel for the purpose of interview and discussion related to such documents.

c. As required by 2 C.F.R. §200.333, the Sub-Recipient shall retain sufficient records to show its compliance with the terms of this Agreement, as well as the compliance of all subcontractors or consultants paid from funds under this Agreement, for a period of three (3) years from the date of submission of the final expenditure report. The following are the only exceptions to the three (3) year requirement:

i. If any litigation, claim, or audit is started before the expiration of the 3-year period, then the records must be retained until all litigation, claims, or audit findings involving the records have been resolved and final action taken.

ii. When the Division or the Sub-Recipient is notified in writing by the Federal awarding agency, cognizant agency for audit, oversight agency for audit, cognizant agency for indirect costs, or pass-through entity to extend the retention period.

iii. Records for real property and equipment acquired with Federal funds must be retained for 3 years after final disposition.

iv. When records are transferred to or maintained by the Federal awarding agency or pass-through entity, the 3-year retention requirement is not applicable to the Sub-Recipient.

v. Records for program income transactions after the period of performance. In some cases recipients must report program income after the period of performance. Where there is such a requirement, the retention period for the records pertaining to the earning of the program income starts from the end of the non-Federal entity's fiscal year in which the program income is earned.

vi. Indirect cost rate proposals and cost allocations plans. This paragraph applies to the following types of documents and their supporting records: indirect cost rate computations or proposals, cost allocation plans, and any similar accounting computations of the rate at which a particular group of costs is chargeable (such as computer usage chargeback rates or composite fringe benefit rates).

d. In accordance with 2 C.F.R. §200.334, the Federal awarding agency must request transfer of certain records to its custody from the Division or the Sub-Recipient when it determines that the records possess long-term retention value.

e. In accordance with 2 C.F.R. §200.335, the Division must always provide or accept paper versions of Agreement information to and from the Sub-Recipient upon request. If paper copies are submitted, then the Division must not require more than an original and two copies. When original records are electronic and cannot be altered, there is no need to create and retain paper copies. When original records are paper, electronic versions may be substituted through the use of duplication or other forms of electronic media provided that they are subject to periodic quality control reviews, provide reasonable safeguards against alteration, and remain readable.

f. As required by 2 C.F.R. §200.303, the Sub-Recipient shall take reasonable measures to safeguard protected personally identifiable information and other information the Federal awarding agency or the Division designates as sensitive or the Sub-Recipient considers sensitive consistent with applicable Federal, state, local, and tribal laws regarding privacy and obligations of confidentiality.

g. Florida's Government in the Sunshine Law (Section 286.011, Florida Statutes) provides the citizens of Florida with a right of access to governmental proceedings and mandates three, basic requirements: (1) meetings of public boards or commissions must be open to the public; (2) reasonable notice of such meetings must be given; and, (3) minutes of the meetings must be taken and

promptly recorded. The mere receipt of public funds by a private entity, standing alone, is insufficient to bring that entity within the ambit of the open government requirements. However, the Government in the Sunshine Law applies to private entities that provide services to governmental agencies and that act on behalf of those agencies in the agencies' performance of their public duties. If a public agency delegates the performance of its public purpose to a private entity, then, to the extent that private entity is performing that public purpose, the Government in the Sunshine Law applies. For example, if a volunteer fire department provides firefighting services to a governmental entity and uses facilities and equipment purchased with public funds, then the Government in the Sunshine Law applies to board of directors for that volunteer fire department. Thus, to the extent that the Government in the Sunshine Law applies to the Sub-Recipient based upon the funds provided under this Agreement, the meetings of the Sub-Recipient's governing board or the meetings of any subcommittee making recommendations to the governing board may be subject to open government requirements. These meetings shall be publicly noticed, open to the public, and the minutes of all the meetings shall be public records, available to the public in accordance with Chapter 119, Florida Statutes.

h. Florida's Public Records Law provides a right of access to the records of the state and local governments as well as to private entities acting on their behalf. Unless specifically exempted from disclosure by the Legislature, all materials made or received by a governmental agency (or a private entity acting on behalf of such an agency) in conjunction with official business which are used to perpetuate, communicate, or formalize knowledge qualify as public records subject to public inspection. The mere receipt of public funds by a private entity, standing alone, is insufficient to bring that entity within the ambit of the public record requirements. However, when a public entity delegates a public function to a private entity, the records generated by the private entity's performance of that duty become public records. Thus, the nature and scope of the services provided by a private entity determine whether that entity is acting on behalf of a public agency and is therefore subject to the requirements of Florida's Public Records Law.

i. the Sub-Recipient shall maintain all records for the Sub-Recipient and for all subcontractors or consultants to be paid from funds provided under this Agreement, including documentation of all program costs, in a form sufficient to determine compliance with the requirements and objectives of the Budget and Scope of Work - Attachment A - and all other applicable laws and regulations.

(11)AUDITS

a. The Sub-Recipient shall comply with the audit requirements contained in 2 C.F.R. Part 200, Subpart F.

b. In accounting for the receipt and expenditure of funds under this Agreement, the Sub-Recipient shall follow Generally Accepted Accounting Principles ("GAAP"). As defined by 2 C.F.R. §200.49, GAAP "has the meaning specified in accounting standards issued by the Government Accounting Standards Board (GASB) and the Financial Accounting Standards Board (FASB)."

c. When conducting an audit of the Sub-Recipient's performance under this Agreement, the Division shall use Generally Accepted Government Auditing Standards ("GAGAS"). As defined by 2 C.F.R. §200.50, GAGAS, "also known as the Yellow Book, means generally accepted government auditing standards issued by the Comptroller General of the United States, which are applicable to financial audits."

d. If an audit shows that all or any portion of the funds disbursed were not spent in accordance with the conditions of this Agreement, the Sub-Recipient shall be held liable for reimbursement to the Division of all funds not spent in accordance with these applicable regulations and Agreement provisions within thirty days after the Division has notified the Sub-Recipient of such non-compliance.

e. The Sub-Recipient shall have all audits completed by an independent auditor, which is defined in section 215.97(2)(h), Florida Statutes, as "an independent certified public accountant licensed under chapter 473." The independent auditor shall state that the audit complied with the applicable provisions noted above. The audit must be received by the Division no later than nine months from the end of the Sub-Recipient's fiscal year.

f. The Sub-Recipient shall send copies of reporting packages for audits conducted in accordance with 2 C.F.R. Part 200, by or on behalf of the Sub-Recipient, to the Division at the following address:

DEMSingle_Audit@em.myflorida.com

DEMSingle_Audit@em.myflorida.com

OR

Office of the Inspector General

2555 Shumard Oak Boulevard

Tallahassee, Florida 32399-2100

g. The Sub-Recipient shall send the Single Audit reporting package and Form SF-SAC to the Federal Audit Clearinghouse by submission online at:

<http://harvester.census.gov/fac/collect/ddeindex.html>

h. The Sub-Recipient shall send any management letter issued by the auditor to the Division at the following address:

DEMSingle_Audit@em.myflorida.com

DEMSingle_Audit@em.myflorida.com

OR

Office of the Inspector General

2555 Shumard Oak Boulevard

Tallahassee, Florida 32399-2100

(12)REPORTS

a. Consistent with 2 C.F.R. §200.328, the Sub-Recipient shall provide the Division with quarterly reports and a close-out report. These reports shall include the current status and progress by the Sub-Recipient and all subcontractors in completing the work described in the Scope of Work and the expenditure of funds under this Agreement, in addition to any other information requested by the Division.

b. Quarterly reports are due to the Division no later than 15 days after the end of each quarter of the program year and shall be sent each quarter until submission of the administrative close-out report. The ending dates for each quarter of the program year are March 31, June 30, September 30 and December 31.

c. The close-out report is due 60 days after termination of this Agreement or 60 days after completion of the activities contained in this Agreement, whichever first occurs.

d. If all required reports and copies are not sent to the Division or are not completed in a manner acceptable to the Division, then the Division may withhold further payments until they are completed or may take other action as stated in Paragraph (16) REMEDIES. "Acceptable to the Division" means that the work product was completed in accordance with the Budget and Scope of Work.

e. The Sub-Recipient shall provide additional program updates or information that may be required by the Division.

f. The Sub-Recipient shall provide additional reports and information identified in Attachment D.

(13)MONITORING

a. The Sub-Recipient shall monitor its performance under this Agreement, as well as that of its subcontractors and/or consultants who are paid from funds provided under this Agreement, to ensure that time schedules are being met, the Schedule of Deliverables and Scope of Work are being accomplished within the specified time periods, and other performance goals are being achieved. A review shall be done for each function or activity in Attachment A to this Agreement, and reported in the quarterly report.

b. In addition to reviews of audits, monitoring procedures may include, but not be limited to, on-site visits by Division staff, limited scope audits, and/or other procedures. The Sub-Recipient agrees to comply and cooperate with any monitoring procedures/processes deemed appropriate by the Division. In the event that the Division determines that a limited scope audit of the Sub-Recipient is appropriate, the Sub-Recipient agrees to comply with any additional instructions provided by the Division to the Sub-Recipient regarding such audit. The Sub-Recipient further agrees to comply and cooperate with any inspections, reviews, investigations or audits deemed necessary by the Florida Chief Financial Officer or Auditor General. In addition, the Division will monitor the performance and financial management by the Sub-Recipient throughout the contract term to ensure timely completion of all tasks.

(14)LIABILITY

a. Unless Sub-Recipient is a State agency or subdivision, as defined in section 768.28(2), Florida Statutes, the Sub-Recipient is solely responsible to parties it deals with in carrying out the terms of this Agreement; as authorized by section 768.28(19), Florida Statutes, Sub-Recipient shall hold the Division harmless against all claims of whatever nature by third parties arising from the work performance under this Agreement. For purposes of this Agreement, Sub-Recipient agrees that it is not an employee or agent of the Division, but is an independent contractor.

b. As required by section 768.28(19), Florida Statutes, any Sub-Recipient which is a state agency or subdivision, as defined in section 768.28(2), Florida Statutes, agrees to be fully responsible for its negligent or tortious acts or omissions which result in claims or suits against the Division, and agrees to be liable for any damages proximately caused by the acts or omissions to the extent set forth in Section 768.28, Florida Statutes. Nothing herein is intended to serve as a waiver of sovereign immunity by any Sub-Recipient to which sovereign immunity applies. Nothing herein shall be construed as consent by a state agency or subdivision of the State of Florida to be sued by third parties in any matter arising out of any contract.

(15)DEFAULT.

If any of the following events occur ("Events of Default"), all obligations on the part of the Division to make further payment of funds shall terminate and the Division has the option to exercise any of its remedies set forth in Paragraph (16); however, the Division may make payments or partial payments after any Events of Default without waiving the right to exercise such remedies, and without becoming liable to make any further payment:

a. If any warranty or representation made by the Sub-Recipient in this Agreement or any previous agreement with the Division is or becomes false or misleading in any respect, or if the Sub-Recipient fails to keep or perform any of the obligations, terms or covenants in this Agreement or any previous agreement with the Division and has not cured them in timely fashion, or is unable or unwilling to meet its obligations under this Agreement;

b. If material adverse changes occur in the financial condition of the Sub-Recipient at any time during the term of this Agreement, and the Sub-Recipient fails to cure this adverse change within thirty days from the date written notice is sent by the Division;

c. If any reports required by this Agreement have not been submitted to the Division or have been submitted with incorrect, incomplete or insufficient information; or,

d. If the Sub-Recipient has failed to perform and complete on time any of its obligations under this Agreement.

(16)REMEDIES.

If an Event of Default occurs, then the Division shall, after thirty calendar days written notice to the Sub-Recipient and upon the Sub-Recipient's failure to cure within those thirty days, exercise any one or more of the following remedies, either concurrently or consecutively:

- a. Terminate this Agreement, provided that the Sub-Recipient is given at least thirty days prior written notice of the termination. The notice shall be effective when placed in the United States, first class mail, postage prepaid, by registered or certified mail-return receipt requested, to the address in paragraph (3) herein;
- b. Begin an appropriate legal or equitable action to enforce performance of this Agreement;
- c. Withhold or suspend payment of all or any part of a request for payment;
- d. Require that the Sub-Recipient refund to the Division any monies used for ineligible purposes under the laws, rules and regulations governing the use of these funds.
- e. Exercise any corrective or remedial actions, to include but not be limited to:
 - i. Request additional information from the Sub-Recipient to determine the reasons for or the extent of non-compliance or lack of performance,
 - ii. Issue a written warning to advise that more serious measures may be taken if the situation is not corrected,
 - iii. Advise the Sub-Recipient to suspend, discontinue or refrain from incurring costs for any activities in question or
 - iv. Require the Sub-Recipient to reimburse the Division for the amount of costs incurred for any items determined to be ineligible;
- f. Exercise any other rights or remedies which may be available under law.

Pursuing any of the above remedies will not stop the Division from pursuing any other remedies in this Agreement or provided at law or in equity. If the Division waives any right or remedy in this Agreement or fails to insist on strict performance by the Sub-Recipient, it will not affect, extend or waive any other right or remedy of the Division, or affect the later exercise of the same right or remedy by the Division for any other default by the Sub-Recipient.

(17)TERMINATION.

- a. The Division may terminate this Agreement for cause after thirty days written notice. Cause can include misuse of funds, fraud, lack of compliance with applicable rules, laws and regulations, failure to perform on time, and refusal by the Sub-Recipient to permit public access to any document, paper, letter, or other material subject to disclosure under Chapter 119, Florida Statutes, as amended.
- b. The Division may terminate this Agreement for convenience or when it determines, in its sole discretion, that continuing the Agreement would not produce beneficial results in line with the further expenditure of funds, by providing the Sub-Recipient with thirty calendar days prior written notice.
- c. The parties may agree to terminate this Agreement for their mutual convenience through a written amendment of this Agreement. The amendment will state the effective date of the termination and the procedures for proper closeout of the Agreement.
- d. In the event that this Agreement is terminated, the Sub-Recipient will not incur new obligations for the terminated portion of the Agreement after the Sub-Recipient has received the

notification of termination. The Sub-Recipient will cancel as many outstanding obligations as possible. Costs incurred after receipt of the termination notice will be disallowed. The Sub-Recipient shall not be relieved of liability to the Division because of any breach of Agreement by the Sub-Recipient. The Division may, to the extent authorized by law, withhold payments to the Sub-Recipient for the purpose of set-off until the exact amount of damages due the Division from the Sub-Recipient is determined.

(18)PROCUREMENT

a. The Sub-Recipient shall ensure that any procurement involving funds authorized by the Agreement complies with all applicable federal and state laws and regulations, to include 2 C.F.R. §§200.318 through 200.326 as well as Appendix II to 2 C.F.R. Part 200 (entitled "Contract Provisions for Non-Federal Entity Contracts Under Federal Awards").

b. As required by 2 C.F.R. §200.318(b), the Sub-Recipient shall "maintain records sufficient to detail the history of procurement. These records will include, but are not necessarily limited to the following: rationale for the method of procurement, selection of contract type, contractor selection or rejection, and the basis for the contract price."

c. As required by 2 C.F.R. §200.318(i), the Sub-Recipient shall "maintain oversight to ensure that contractors perform in accordance with the terms, conditions, and specifications of their contracts or purchase orders." In order to demonstrate compliance with this requirement, the Sub-Recipient shall document, in its quarterly report to the Division, the progress of any and all subcontractors performing work under this Agreement.

d. Except for procurements by micro-purchases pursuant to 2 C.F.R. §200.320(a) or procurements by small purchase procedures pursuant to 2 C.F.R. §200.320(b), if the Sub-Recipient chooses to subcontract any of the work required under this Agreement, then the Sub-Recipient shall forward to the Division a copy of any solicitation (whether competitive or non-competitive) at least fifteen (15) days prior to the publication or communication of the solicitation. The Division shall review the solicitation and provide comments, if any, to the Sub-Recipient within three (3) business days. Consistent with 2 C.F.R. §200.324, the Division will review the solicitation for compliance with the procurement standards outlined in 2 C.F.R. §§200.318 through 200.326 as well as Appendix II to 2 C.F.R. Part 200. Consistent with 2 C.F.R. §200.318(k), the Division will not substitute its judgment for that of the Sub-Recipient. While the Sub-Recipient does not need the approval of the Division in order to publish a competitive solicitation, this review may allow the Division to identify deficiencies in the vendor requirements or in the commodity or service specifications. The Division's review and comments shall not constitute an approval of the solicitation. Regardless of the Division's review, the Sub-Recipient remains bound by all applicable laws, regulations, and agreement terms. If during its review the Division identifies any deficiencies, then the Division shall communicate those deficiencies to the Sub-Recipient as quickly as possible within the three (3) business day window outlined above. If the Sub-Recipient publishes a competitive solicitation after receiving comments from the Division that the solicitation is deficient, then the Division may:

- i. Terminate this Agreement in accordance with the provisions outlined in paragraph 17 above; and,
- ii. Refuse to reimburse the Sub-Recipient for any costs associated with that solicitation.

e. Except for procurements by micro-purchases pursuant to 2 C.F.R. §200.320(a) or procurements by small purchase procedures pursuant to 2 C.F.R. §200.320(b), if the Sub-Recipient chooses to subcontract any of the work required under this Agreement, then the Sub-Recipient shall forward to the Division a copy of any contemplated contract prior to contract execution. The Division shall review the unexecuted contract and provide comments, if any, to the Sub-Recipient within three (3) business days. Consistent with 2 C.F.R. §200.324, the Division will review the unexecuted contract for compliance with the procurement standards outlined in 2 C.F.R. §§200.318 through 200.326 as well as Appendix II to 2 C.F.R. Part 200. Consistent with 2 C.F.R. §200.318(k), the Division will not substitute its judgment for that of the Sub-Recipient. While the Sub-Recipient does not need the approval of the Division in order to execute a subcontract, this review may allow the Division to identify deficiencies in the terms and conditions of the subcontract as well as deficiencies in the procurement process that led to the subcontract. The Division's review and comments shall not constitute an approval of the subcontract. Regardless of the Division's review, the Sub-Recipient remains bound by all applicable laws, regulations, and agreement terms. If during its review the Division identifies any deficiencies, then the Division shall communicate those deficiencies to the Sub-Recipient as quickly as possible within the three (3) business day window outlined above. If the Sub-Recipient executes a subcontract after receiving a communication from the Division that the subcontract is non-compliant, then the Division may:

- i. Terminate this Agreement in accordance with the provisions outlined in paragraph 17 above; and,
- ii. Refuse to reimburse the Sub-Recipient for any costs associated with that subcontract.

f. The Sub-Recipient agrees to include in the subcontract that (i) the subcontractor is bound by the terms of this Agreement, (ii) the subcontractor is bound by all applicable state and federal laws and regulations, and (iii) the subcontractor shall hold the Division and Sub-Recipient harmless against all claims of whatever nature arising out of the subcontractor's performance of work under this Agreement, to the extent allowed and required by law.

g. As required by 2 C.F.R. §200.318(c)(1), the Sub-Recipient shall "maintain written standards of conduct covering conflicts of interest and governing the actions of its employees engaged in the selection, award and administration of contracts."

h. As required by 2 C.F.R. §200.319(a), the Sub-Recipient shall conduct any procurement under this agreement "in a manner providing full and open competition." Accordingly, the Sub-Recipient shall not:

- i. Place unreasonable requirements on firms in order for them to qualify to do business;
- ii. Require unnecessary experience or excessive bonding;
- iii. Use noncompetitive pricing practices between firms or between affiliated companies;
- iv. Execute noncompetitive contracts to consultants that are on retainer contracts;
- v. Authorize, condone, or ignore organizational conflicts of interest;
- vi. Specify only a brand name product without allowing vendors to offer an equivalent;
- vii. Specify a brand name product instead of describing the performance, specifications, or other relevant requirements that pertain to the commodity or service solicited by the procurement;
- viii. Engage in any arbitrary action during the procurement process; or,
- ix. Allow a vendor to bid on a contract if that bidder was involved with developing or drafting the specifications, requirements, statement of work, invitation to bid, or request for proposals.

i. "Except in those cases where applicable Federal statutes expressly mandate or encourage" otherwise, the Sub-Recipient, as required by 2 C.F.R. §200.319(b), shall not use a geographic preference when procuring commodities or services under this Agreement.

j. The Sub-Recipient shall conduct any procurement involving invitations to bid (i.e. sealed bids) in accordance with 2 C.F.R. §200.320(c) as well as section 287.057(1)(a), Florida Statutes.

k. The Sub-Recipient shall conduct any procurement involving requests for proposals (i.e. competitive proposals) in accordance with 2 C.F.R. §200.320(d) as well as section 287.057(1)(b), Florida Statutes.

l. For each subcontract, the Sub-Recipient shall provide a written statement to the Division as to whether that subcontractor is a minority business enterprise, as defined in Section 288.703, Florida Statutes. Additionally, the Sub-Recipient shall comply with the requirements of 2 C.F.R. §200.321 ("Contracting with small and minority businesses, women's business enterprises, and labor surplus area firms").

(19) ATTACHMENTS

- a. All attachments to this Agreement are incorporated as if set out fully.
- b. In the event of any inconsistencies or conflict between the language of this Agreement and the attachments, the language of the attachments shall control, but only to the extent of the conflict or inconsistency.
- c. This Agreement has the following attachments:
 - i. Exhibit 1 - Funding Sources

- ii. Attachment A – Budget and Scope of Work
- iii. Attachment B – Program Statutes and Regulations
- iv. Attachment C – Statement of Assurances
- v. Attachment D – Request for Advance or Reimbursement
- vi. Attachment E – Justification of Advance Payment
- vii. Attachment F – Quarterly Report Form
- viii. Attachment G – Warranties and Representations
- ix. Attachment H – Certification Regarding Debarment, Suspension, Ineligibility
- x. Attachment I – Federal Funding Accountability and Transparency Act
- xi. Attachment J – Mandatory Contract Provisions

(20)PAYMENTS

a. Any advance payment under this Agreement is subject to 2 C.F.R. §200.305 and, as applicable, section 216.181(16), Florida Statutes. All advances are required to be held in an interest-bearing account. If an advance payment is requested, the budget data on which the request is based and a justification statement shall be included in this Agreement as Attachment E. Attachment E will specify the amount of advance payment needed and provide an explanation of the necessity for and proposed use of these funds. No advance shall be accepted for processing if a reimbursement has been paid prior to the submittal of a request for advanced payment. After the initial advance, if any, payment shall be made on a reimbursement basis as needed.

b. Invoices shall be submitted at least quarterly and shall include the supporting documentation for all costs of the project or services. The final invoice shall be submitted within sixty (60) days after the expiration date of the agreement. An explanation of any circumstances prohibiting the submittal of quarterly invoices shall be submitted to the Division grant manager as part of the Sub-Recipient's quarterly reporting as referenced in Paragraph 7 of this Agreement.

c. If the necessary funds are not available to fund this Agreement as a result of action by the United States Congress, the federal Office of Management and Budgeting, the State Chief Financial Officer or under subparagraph (9)b. of this Agreement, all obligations on the part of the Division to make any further payment of funds shall terminate, and the Sub-Recipient shall submit its closeout report within thirty days of receiving notice from the Division.

(21)REPAYMENTS

a. All refunds or repayments due to the Division under this Agreement are to be made payable to the order of "Division of Emergency Management", and mailed directly to the following address:

Division of Emergency Management
Cashier
2555 Shumard Oak Boulevard
Tallahassee FL 32399-2100

b. In accordance with Section 215.34(2), Florida Statutes, if a check or other draft is returned to the Division for collection, Sub-Recipient shall pay the Division a service fee of \$15.00 or 5% of the face amount of the returned check or draft, whichever is greater.

(22) MANDATED CONDITIONS

a. The validity of this Agreement is subject to the truth and accuracy of all the information, representations, and materials submitted or provided by the Sub-Recipient in this Agreement, in any later submission or response to a Division request, or in any submission or response to fulfill the requirements of this Agreement. All of said information, representations, and materials are incorporated by reference. The inaccuracy of the submissions or any material changes shall, at the option of the Division and with thirty days written notice to the Sub-Recipient, cause the termination of this Agreement and the release of the Division from all its obligations to the Sub-Recipient.

b. This Agreement shall be construed under the laws of the State of Florida, and venue for any actions arising out of this Agreement shall be in the Circuit Court of Leon County. If any provision of this Agreement is in conflict with any applicable statute or rule, or is unenforceable, then the provision shall be null and void to the extent of the conflict, and shall be severable, but shall not invalidate any other provision of this Agreement.

c. Any power of approval or disapproval granted to the Division under the terms of this Agreement shall survive the term of this Agreement.

d. The Sub-Recipient agrees to comply with the Americans With Disabilities Act (Public Law 101-336, 42 U.S.C. Section 12101 et seq.), which prohibits discrimination by public and private entities on the basis of disability in employment, public accommodations, transportation, State and local government services, and telecommunications.

e. Those who have been placed on the convicted vendor list following a conviction for a public entity crime or on the discriminatory vendor list may not submit a bid on a contract to provide any goods or services to a public entity, may not submit a bid on a contract with a public entity for the construction or repair of a public building or public work, may not submit bids on leases of real property to a public entity, may not be awarded or perform work as a contractor, supplier, subcontractor, or consultant under a contract with a public entity, and may not transact business with any public entity in excess of \$25,000.00 for a period of 36 months from the date of being placed on the convicted vendor list or on the discriminatory vendor list.

f. Any Sub-Recipient which is not a local government or state agency, and which receives funds under this Agreement from the federal government, certifies, to the best of its knowledge and belief, that it and its principals:

i. Are not presently debarred, suspended, proposed for debarment, declared ineligible, or voluntarily excluded from covered transactions by a federal department or agency;

ii. Have not, within a five-year period preceding this proposal been convicted of or had a civil judgment rendered against them for fraud or a criminal offense in connection with obtaining,

attempting to obtain, or performing a public (federal, state or local) transaction or contract under public transaction; violation of federal or state antitrust statutes or commission of embezzlement, theft, forgery, bribery, falsification or destruction of records, making false statements, or receiving stolen property;

iii. Are not presently indicted or otherwise criminally or civilly charged by a governmental entity (federal, state or local) with commission of any offenses enumerated in paragraph 19(g)2. of this certification; and,

iv. Have not within a five-year period preceding this Agreement had one or more public transactions (federal, state or local) terminated for cause or default.

g. If the Sub-Recipient is unable to certify to any of the statements in this certification, then the Sub-Recipient shall attach an explanation to this Agreement.

h. In addition, the Sub-Recipient shall send to the Division (by email or by facsimile transmission) the completed "Certification Regarding Debarment, Suspension, Ineligibility And Voluntary Exclusion" (Attachment H) for each intended subcontractor which Sub-Recipient plans to fund under this Agreement. The form must be received by the Division before the Sub-Recipient enters into a contract with any subcontractor.

i. The Division reserves the right to unilaterally cancel this Agreement if the Sub-Recipient refuses to allow public access to all documents, papers, letters or other material subject to the provisions of Chapter 119, Florida Statutes, which the Sub-Recipient created or received under this Agreement.

j. If the Sub-Recipient is allowed to temporarily invest any advances of funds under this Agreement, any interest income shall either be returned to the Division or be applied against the Division's obligation to pay the contract amount.

k. The State of Florida will not intentionally award publicly-funded contracts to any contractor who knowingly employs unauthorized alien workers, constituting a violation of the employment provisions contained in 8 U.S.C. Section 1324a(e) [Section 274A(e) of the Immigration and Nationality Act ("INA")]. The Division shall consider the employment by any contractor of unauthorized aliens a violation of Section 274A(e) of the INA. Such violation by the Sub-Recipient of the employment provisions contained in Section 274A(e) of the INA shall be grounds for unilateral cancellation of this Agreement by the Division.

l. All unmanufactured and manufactured articles, materials and supplies which are acquired for public use under this Agreement must have been produced in the United States as required under 41 U.S.C. 10a, unless it would not be in the public interest or unreasonable in cost.

(23) LOBBYING PROHIBITION

a. 2 C.F.R. §200.450 prohibits reimbursement for costs associated with certain lobbying activities.

b. Section 216.347, Florida Statutes, prohibits "any disbursement of grants and aids appropriations pursuant to a contract or grant to any person or organization unless the terms of the grant

or contract prohibit the expenditure of funds for the purpose of lobbying the Legislature, the judicial branch, or a state agency."

c. No funds or other resources received from the Division under this Agreement may be used directly or indirectly to influence legislation or any other official action by the Florida Legislature or any state agency.

d. The Sub-Recipient certifies, by its signature to this Agreement, that to the best of his or her knowledge and belief:

i. No Federal appropriated funds have been paid or will be paid, by or on behalf of the Sub-Recipient, to any person for influencing or attempting to influence an officer or employee of any agency, a Member of Congress, an officer or employee of Congress, or an employee of a Member of Congress in connection with the awarding of any Federal contract, the making of any Federal grant, the making of any Federal loan, the entering into of any cooperative agreement, and the extension, continuation, renewal, amendment or modification of any Federal contract, grant, loan or cooperative agreement.

ii. If any funds other than Federal appropriated funds have been paid or will be paid to any person for influencing or attempting to influence an officer or employee of any agency, a Member of Congress, an officer or employee of Congress, or an employee of a Member of Congress in connection with this Federal contract, grant, loan or cooperative agreement, the Sub-Recipient shall complete and submit Standard Form-LLL, "Disclosure of Lobbying Activities."

iii. The Sub-Recipient shall require that this certification be included in the award documents for all subawards (including subcontracts, subgrants, and contracts under grants, loans, and cooperative agreements) and that all Sub-Recipients shall certify and disclose.

iv. This certification is a material representation of fact upon which reliance was placed when this transaction was made or entered into. Submission of this certification is a prerequisite for making or entering into this transaction imposed by Section 1352, Title 31, U.S. Code. Any person who fails to file the required certification shall be subject to a civil penalty of not less than \$10,000 and not more than \$100,000 for each such failure.

(24) COPYRIGHT, PATENT AND TRADEMARK

EXCEPT AS PROVIDED BELOW, ANY AND ALL PATENT RIGHTS ACCRUING UNDER OR IN CONNECTION WITH THE PERFORMANCE OF THIS AGREEMENT ARE HEREBY RESERVED TO THE STATE OF FLORIDA; AND, ANY AND ALL COPYRIGHTS ACCRUING UNDER OR IN CONNECTION WITH THE PERFORMANCE OF THIS AGREEMENT ARE HEREBY TRANSFERRED BY THE SUB-RECIPIENT TO THE STATE OF FLORIDA.

a. If the Sub-Recipient has a pre-existing patent or copyright, the Sub-Recipient shall retain all rights and entitlements to that pre-existing patent or copyright unless the Agreement provides otherwise.

b. If any discovery or invention is developed in the course of or as a result of work or services performed under this Agreement, or in any way connected with it, the Sub-Recipient shall refer the discovery or invention to the Division for a determination whether the State of Florida will seek patent protection in its name. Any patent rights accruing under or in connection with the performance of this Agreement are reserved to the State of Florida. If any books, manuals, films, or other copyrightable material are produced, the Sub-Recipient shall notify the Division. Any copyrights accruing under or in connection with the performance under this Agreement are transferred by the Sub-Recipient to the State of Florida.

c. Within thirty days of execution of this Agreement, the Sub-Recipient shall disclose all intellectual properties relating to the performance of this Agreement which he or she knows or should know could give rise to a patent or copyright. The Sub-Recipient shall retain all rights and entitlements to any pre-existing intellectual property which is disclosed. Failure to disclose will indicate that no such property exists. The Division shall then, under Paragraph (b), have the right to all patents and copyrights which accrue during performance of the Agreement.

d. If the Sub-Recipient qualifies as a state university under Florida law, then, pursuant to section 1004.23, Florida Statutes, any invention conceived exclusively by the employees of the Sub-Recipient shall become the sole property of the Sub-Recipient. In the case of joint inventions, that is inventions made jointly by one or more employees of both parties hereto, each party shall have an equal, undivided interest in and to such joint inventions. The Division shall retain a perpetual, irrevocable, fully-paid, nonexclusive license, for its use and the use of its contractors of any resulting patented, copyrighted or trademarked work products, developed solely by the Sub-Recipient, under this Agreement, for Florida government purposes.

(25) LEGAL AUTHORIZATION

The Sub-Recipient certifies that it has the legal authority to receive the funds under this Agreement and that its governing body has authorized the execution and acceptance of this Agreement. The Sub-Recipient also certifies that the undersigned person has the authority to legally execute and bind Sub-Recipient to the terms of this Agreement.

(26) EQUAL OPPORTUNITY EMPLOYMENT

a. In accordance with 41 C.F.R. §60-1.4(b), the Sub-Recipient hereby agrees that it will incorporate or cause to be incorporated into any contract for construction work, or modification thereof, as defined in the regulations of the Secretary of Labor at 41 CFR Chapter 60, which is paid for in whole or in part with funds obtained from the Federal Government or borrowed on the credit of the Federal Government pursuant to a grant, contract, loan insurance, or guarantee, or undertaken pursuant to any Federal program involving such grant, contract, loan, insurance, or guarantee, the following equal opportunity clause:

During the performance of this contract, the contractor agrees as follows:

i. The contractor will not discriminate against any employee or applicant for employment because of race, color, religion, sex, or national origin. The contractor will take affirmative action to ensure that applicants are employed, and that employees are treated during employment without regard to their race, color, religion, sex, or national origin. Such action shall include, but not be limited to the following: employment, upgrading, demotion, or transfer; recruitment or recruitment advertising; layoff or termination; rates of pay or other forms of compensation; and selection for training, including apprenticeship. The contractor agrees to post in conspicuous places, available to employees and applicants for employment, notices to be provided setting forth the provisions of this nondiscrimination clause.

ii. The contractor will, in all solicitations or advertisements for employees placed by or on behalf of the contractor, state that all qualified applicants will receive considerations for employment without regard to race, color, religion, sex, or national origin.

iii. The contractor will send to each labor union or representative of workers with which he has a collective bargaining agreement or other contract or understanding, a notice to be provided advising the said labor union or workers' representatives of the contractor's commitments under this section, and shall post copies of the notice in conspicuous places available to employees and applicants for employment.

iv. The contractor will comply with all provisions of Executive Order 11246 of September 24, 1965, and of the rules, regulations, and relevant orders of the Secretary of Labor.

v. The contractor will furnish all information and reports required by Executive Order 11246 of September 24, 1965, and by rules, regulations, and orders of the Secretary of Labor, or pursuant thereto, and will permit access to his books, records, and accounts by the administering agency and the Secretary of Labor for purposes of investigation to ascertain compliance with such rules, regulations, and orders.

vi. In the event of the contractor's noncompliance with the nondiscrimination clauses of this contract or with any of the said rules, regulations, or orders, this contract may be canceled, terminated, or suspended in whole or in part and the contractor may be declared ineligible for further Government contracts or federally assisted construction contracts in accordance with procedures authorized in Executive Order 11246 of September 24, 1965, and such other sanctions may be imposed and remedies invoked as provided in Executive Order 11246 of September 24, 1965, or by rule, regulation, or order of the Secretary of Labor, or as otherwise provided by law.

vii. The contractor will include the portion of the sentence immediately preceding paragraph (1) and the provisions of paragraphs (1) through (7) in every subcontract or purchase order unless exempted by rules, regulations, or orders of the Secretary of Labor issued pursuant to section 204 of Executive Order 11246 of September 24, 1965, so that such provisions will be binding upon each subcontractor or vendor. The contractor will take such action with respect to any subcontract or purchase order as the administering agency may direct as a means of

enforcing such provisions, including sanctions for noncompliance: provided, however, that in the event a contractor becomes involved in, or is threatened with, litigation with a subcontractor or vendor as a result of such direction by the administering agency the contractor may request the United States to enter into such litigation to protect the interests of the United States.

b. The Sub-Recipient further agrees that it will be bound by the above equal opportunity clause with respect to its own employment practices when it participates in federally assisted construction work: provided, that if the applicant so participating is a State or local government, the above equal opportunity clause is not applicable to any agency, instrumentality or subdivision of such government which does not participate in work on or under the contract.

c. The Sub-Recipient agrees that it will assist and cooperate actively with the administering agency and the Secretary of Labor in obtaining the compliance of contractors and subcontractors with the equal opportunity clause and the rules, regulations, and relevant orders of the Secretary of Labor, that it will furnish the administering agency and the Secretary of Labor such information as they may require for the supervision of such compliance, and that it will otherwise assist the administering agency in the discharge of the agency's primary responsibility for securing compliance.

d. The Sub-Recipient further agrees that it will refrain from entering into any contract or contract modification subject to Executive Order 11246 of September 24, 1965, with a contractor debarred from, or who has not demonstrated eligibility for, Government contracts and federally assisted construction contracts pursuant to the Executive order and will carry out such sanctions and penalties for violation of the equal opportunity clause as may be imposed upon contractors and subcontractors by the administering agency or the Secretary of Labor pursuant to Part II, Subpart D of the Executive order. In addition, the Sub-Recipient agrees that if it fails or refuses to comply with these undertakings, the administering agency may take any or all of the following actions: cancel, terminate, or suspend in whole or in part this grant (contract, loan, insurance, guarantee); refrain from extending any further assistance to the Sub-Recipient under the program with respect to which the failure or refund occurred until satisfactory assurance of future compliance has been received from such Sub-Recipient; and refer the case to the Department of Justice for appropriate legal proceedings.

(27) COPELAND ANTI-KICKBACK ACT

The Sub-Recipient hereby agrees that, unless exempt under Federal law, it will incorporate or cause to be incorporated into any contract for construction work, or modification thereof, the following clause:

i. Contractor. The contractor shall comply with 18 U.S.C. § 874, 40 U.S.C. § 3145, and the requirements of 29 C.F.R. pt. 3 as may be applicable, which are incorporated by reference into this contract.

ii. Subcontracts. The contractor or subcontractor shall insert in any subcontracts the clause above and such other clauses as the FEMA may by appropriate instructions require, and also a clause requiring the subcontractors to include these clauses in any lower tier subcontracts.

The prime contractor shall be responsible for the compliance by any subcontractor or lower tier subcontractor with all of these contract clauses.

iii. Breach. A breach of the contract clauses above may be grounds for termination of the contract, and for debarment as a contractor and subcontractor as provided in 29 C.F.R. § 5.12.

(28) CONTRACT WORK HOURS AND SAFETY STANDARDS

If the Sub-Recipient, with the funds authorized by this Agreement, enters into a contract that exceeds \$100,000 and involves the employment of mechanics or laborers, then any such contract must include a provision for compliance with 40 U.S.C. 3702 and 3704, as supplemented by Department of Labor regulations (29 CFR Part 5). Under 40 U.S.C. 3702 of the Act, each contractor must be required to compute the wages of every mechanic and laborer on the basis of a standard work week of 40 hours. Work in excess of the standard work week is permissible provided that the worker is compensated at a rate of not less than one and a half times the basic rate of pay for all hours worked in excess of 40 hours in the work week. The requirements of 40 U.S.C. 3704 are applicable to construction work and provide that no laborer or mechanic must be required to work in surroundings or under working conditions which are unsanitary, hazardous or dangerous. These requirements do not apply to the purchases of supplies or materials or articles ordinarily available on the open market, or contracts for transportation.

(29) CLEAN AIR ACT AND THE FEDERAL WATER POLLUTION CONTROL ACT

If the Sub-Recipient, with the funds authorized by this Agreement, enters into a contract that exceeds \$150,000, then any such contract must include the following provision:

Contractor agrees to comply with all applicable standards, orders or regulations issued pursuant to the Clean Air Act (42 U.S.C. 7401-7671q) and the Federal Water Pollution Control Act as amended (33 U.S.C. 1251-1387), and will report violations to FEMA and the Regional Office of the Environmental Protection Agency (EPA).

(30) SUSPENSION AND DEBARMENT

If the Sub-Recipient, with the funds authorized by this Agreement, enters into a contract, then any such contract must include the following provisions:

i. This contract is a covered transaction for purposes of 2 C.F.R. pt. 180 and 2 C.F.R. pt. 3000. As such the contractor is required to verify that none of the contractor, its principals (defined at 2 C.F.R. § 180.995), or its affiliates (defined at 2 C.F.R. § 180.905) are excluded (defined at 2 C.F.R. § 180.940) or disqualified (defined at 2 C.F.R. § 180.935).

ii. The contractor must comply with 2 C.F.R. pt. 180, subpart C and 2 C.F.R. pt. 3000, subpart C and must include a requirement to comply with these regulations in any lower tier covered transaction it enters into.

iii. This certification is a material representation of fact relied upon by the Division. If it is later determined that the contractor did not comply with 2 C.F.R. pt. 180, subpart C and 2 C.F.R. pt. 3000, subpart C, in

addition to remedies available to the Division, the Federal Government may pursue available remedies, including but not limited to suspension and/or debarment.

iv. The bidder or proposer agrees to comply with the requirements of 2 C.F.R. pt. 180, subpart C and 2 C.F.R. pt. 3000, subpart C while this offer is valid and throughout the period of any contract that may arise from this offer. The bidder or proposer further agrees to include a provision requiring such compliance in its lower tier covered transactions.

(31)BYRD ANTI-LOBBYING AMENDMENT

If the Sub-Recipient, with the funds authorized by this Agreement, enters into a contract, then any such contract must include the following clause:

Byrd Anti-Lobbying Amendment, 31 U.S.C. § 1352 (as amended). Contractors who apply or bid for an award of \$100,000 or more shall file the required certification. Each tier certifies to the tier above that it will not and has not used Federal appropriated funds to pay any person or organization for influencing or attempting to influence an officer or employee of any agency, a member of Congress, officer or employee of Congress, or an employee of a member of Congress in connection with obtaining any Federal contract, grant, or any other award covered by 31 U.S.C. § 1352. Each tier shall also disclose any lobbying with non-Federal funds that takes place in connection with obtaining any Federal award. Such disclosures are forwarded from tier to tier up to the recipient.

(32)CONTRACTING WITH SMALL AND MINORITY BUSINESSES, WOMEN'S BUSINESS ENTERPRISES, AND LABOR SURPLUS AREA FIRMS

a. If the Sub-Recipient, with the funds authorized by this Agreement, seeks to procure goods or services, then, in accordance with 2 C.F.R. §200.321, the Sub-Recipient shall take the following affirmative steps to assure that minority businesses, women's business enterprises, and labor surplus area firms are used whenever possible:

- i. Placing qualified small and minority businesses and women's business enterprises on solicitation lists;
- ii. Assuring that small and minority businesses, and women's business enterprises are solicited whenever they are potential sources;
- iii. Dividing total requirements, when economically feasible, into smaller tasks or quantities to permit maximum participation by small and minority businesses, and women's business enterprises;
- iv. Establishing delivery schedules, where the requirement permits, which encourage participation by small and minority businesses, and women's business enterprises;
- v. Using the services and assistance, as appropriate, of such organizations as the Small Business Administration and the Minority Business Development Agency of the Department of Commerce; and

vi. Requiring the prime contractor, if subcontracts are to be let, to take the affirmative steps listed in paragraphs (a) through (e) of this section.

b. The requirement outlined in subparagraph a. above, sometimes referred to as "socioeconomic contracting," does not impose an obligation to set aside either the solicitation or award of a contract to these types of firms. Rather, the requirement only imposes an obligation to carry out and document the six affirmative steps identified above.

c. The "socioeconomic contracting" requirement outlines the affirmative steps that the Sub-Recipient must take; the requirements do not preclude the Sub-Recipient from undertaking additional steps to involve small and minority businesses and women's business enterprises.

d. The requirement to divide total requirements, when economically feasible, into smaller tasks or quantities to permit maximum participation by small and minority businesses, and women's business enterprises, does not authorize the Sub-Recipient to break a single project down into smaller components in order to circumvent the micro-purchase or small purchase thresholds so as to utilize streamlined acquisition procedures (e.g. "project splitting").

(33)ASSURANCES.

The Sub-Recipient shall comply with any Statement of Assurances incorporated as Attachment C.

IN WITNESS WHEREOF, the parties hereto have executed this Agreement.

SUB-RECIPIENT: _____

By: _____

Name and Title: _____

Date: _____

FID#: _____

**STATE OF FLORIDA
DIVISION OF EMERGENCY MANGEMENT**

By: _____

Name and Title: Wesley Maul, Interim Director

Date: _____

EXHIBIT – 1

THE FOLLOWING FEDERAL RESOURCES ARE AWARDED TO THE SUB-RECIPIENT UNDER THIS AGREEMENT:

Federal Program: Federal Emergency Management Agency: Hazard Mitigation Grant
Catalog of Federal Domestic Assistance Number: 97.039
Amount of Federal Funding: \$ _____

THE FOLLOWING COMPLIANCE REQUIREMENTS APPLY TO THE FEDERAL RESOURCES AWARDED UNDER THIS AGREEMENT:

- 2 CFR Part 200 Uniform Administrative Requirements, Cost Principles, and Audit Requirements for Federal Awards

Commonly Applicable Statutes and Regulations

- The Robert T. Stafford Disaster Relief and Emergency Assistance Act, Public Law 93-288, as amended, 42 U.S.C. 5121 et seq., and Related Authorities
- Sections 1361(A) of the National Flood Insurance Act of 1968 (NFIA, or "the Act"), 42 U.S.C. 4104c, as amended by the National Flood Insurance Reform Act of 1994 (NFIRA), Public Law 103-325 and the Bunning-Bereuter-Blumenauer Flood Insurance Reform Act of 2004, Public Law 108-264
- 31 CFR Part 205 Rules and Procedures for Funds Transfers

Federal Program:

List applicable compliance requirements as follows:

1. Sub-Recipient is to use funding to perform the following eligible activities:
 - Elevation of flood prone structures
 - Localized Minor Drainage Improvement
2. Sub-Recipient is subject to all administrative and financial requirements as set forth in this Agreement, or will be in violation of the terms of the Agreement.

NOTE: Section 200.331(a)(1) of 2 C.F.R., as revised, and Section 215.97(5)(a), Florida Statutes, require that the information about Federal Programs and State Projects included on pg. 1 of this sub-grant agreement and in Exhibit 1 be provided to the Sub-Recipient.

Attachment A
Budget and Scope of Work

STATEMENT OF PURPOSE:

The purpose of this Scope of Work (SOW) is to improve drainage on Front Beach Road, located in Panama City Beach, Bay County, Florida; funded through the Hazard Mitigation Grant Program (HMGP) **DR-4138-5-A** as approved by the Florida Division of Emergency Management (Division) and the Federal Emergency Management Agency (FEMA).

The Sub-Recipient, City of Panama City Beach, agrees to administer and complete the project per sealed engineering designs and construction plans as submitted by the Sub-Recipient and subsequently approved by the Division and FEMA. The Sub-Recipient shall complete the work in accordance with all applicable Federal, State and Local Laws, Regulations and Codes.

PROJECT OVERVIEW:

As a Hazard Mitigation Grant Program project, the Sub-Recipient proposes to improve the drainage at Front Beach Road located about 0.1 miles east from intersection of South Thomas Drive and Front Beach Road in Panama City Beach, Florida 32407.

The Phase II – Construction scope of work proposed drainage includes the installation of two (2) additional 54" Reinforced Concrete Pipe (RCP) Culverts under Front Beach Road in the Florida Department of Transportation (FDOT) right of way, and modification of existing weir. The project shall also include new FDOT index 250 Concrete Headwalls, major utility relocations and stabilization sod to complete the project.

When completed the project shall provide protection against a 25-year storm event.
Sub-Recipient.

TASKS & DELIVERABLES:

A) Tasks

- 1) The Sub-Recipient shall procure the services of a qualified and licensed Florida contractor and execute a contract with the selected bidder to complete the scope of work as approved by the Division and FEMA. The Sub-Recipient shall select the qualified, licensed Florida contractor in accordance with the Sub-Recipient's procurement policy as well as all federal and state laws and regulations. All procurement activities shall contain sufficient source documentation and be in accordance with all applicable regulations.

The Sub-Recipient shall be responsible for furnishing or contracting all labor, materials, equipment, tools, transportation and supervision and for performing all work per sealed engineering designs and construction plans presented to the Division by the Sub-Recipient and subsequently approved by the Division and FEMA.

The Sub-Recipient and contractor shall be responsible for maintaining a safe and secure worksite for the duration of the work. The contractor shall maintain all work staging areas in a neat and presentable condition.

The Sub-Recipient shall ensure that no contractors or subcontractors are debarred or suspended from participating in federally funded projects.

The selected contractor shall have a current and valid occupational license/business tax receipt issued for the type of services being performed.

The Sub-Recipient shall provide documentation demonstrating the results of the procurement process. This shall include a rationale for the method of procurement and selection of contract type, contractor selection and/or rejection and bid tabulation and listing, and the basis of contract price.

The Sub-Recipient shall provide an executed "Debarment, Suspension, Ineligibility, Voluntary Exclusion Form" for each contractor and/or subcontractor performing services under this agreement.

The Sub-Recipient shall provide executed contracts with contractors and/or subcontractors to the Division.

The Sub-Recipient shall provide copies of professional licenses for contractors selected to perform services. The Sub-Recipient shall provide a copy of a current and valid occupational license or business tax receipt issued for the type of services to be performed by selected contractor.

- 2) The Sub-Recipient shall monitor and manage the installation to improve the drainage and provide flood protection

The project shall be implemented in accordance with sealed engineering designs and construction plans previously presented to the Division by the Sub-Recipient and subsequently approved by the Division and FEMA. The Sub-Recipient shall ensure that all applicable state, local and federal laws and regulations are followed and documented, as appropriate.

The project consists of the general construction and furnishing of all materials, equipment, labor and fees to minimize recurring flooding and reduce repetitive flood loss to structures and roadways.

The Sub-Recipient shall fully perform the approved project, as described in the submitted documents, in accordance with the approved scope of work, budget line item, allocation of funds and applicable terms and conditions indicated herein. The Sub-Recipient shall not deviate from the approved project terms and conditions.

A qualified and licensed Florida contractor shall complete construction activities. A qualified engineer shall monitor all construction activities. The Sub-Recipient shall complete the project in accordance with all required permits. All work shall be completed in accordance with applicable codes and standards.

Upon completion of the work, the Sub-Recipient shall schedule and participate in a final inspection of the completed project by the local municipal or county official, or other approving official, as applicable. The official shall inspect and certify that all installation was in accordance with the manufacturer's specifications. Any deficiencies found during this final inspection shall be corrected by the Sub-Recipient prior to Sub-Recipient's submittal of the final inspection request to the Division.

Upon completion of Task 2, the Sub-Recipient shall submit the following documents with sufficient supporting documentation, and provide a summary of all contract scope of work and scope of work changes, if any. Additional documentation for closeout shall include:

- a) Signed and Sealed As-built project plans (drawings) by the Professional of Record, two hard copies and electronic version (via email or CD); and
- b) Letter of Completion:
 1. Affirming that the project was completed in conformance with the approved project drawings, specifications and scope; and
 2. Certifying Compliance with all applicable codes;
- c) Letter verifying compliance with the National Historic Preservation Act, to include if archeological materials or human remains were encountered during project activities, if so, how they were handled. Sub-Recipient
- d) Permit(s) and verification of compliance
 1. Copy of the United States Army Corp of Engineers (USACE) As-Built Certification by Professional Engineer for permit number SAJ-2015-00956 (NW-LSL).

- e) Proof of compliance with Project Requirements and Conditions contained herein.
- 3) During the course of this Agreement, the Sub-Recipient shall submit requests for reimbursement. Adequate and complete source documentation shall be submitted to support all costs (federal share and local share) related to the project. In some cases, not all project activities may be fully complete prior to requesting reimbursement of costs incurred in completion of this scope of work; however, a partial reimbursement may be requested.

The Sub-Recipient shall submit an Affidavit signed by the Sub-Recipient's project personnel with each reimbursement request attesting to the completion of the work, disbursements or payments were made in accordance with all agreement and regulatory conditions, and that reimbursement is due and has not been previously requested.

The Sub-Recipient shall maintain accurate time records. The Sub-Recipient shall ensure invoices are accurate and any contracted services were rendered within the terms and timelines of this agreement. All supporting documentation shall agree with the requested billing period. All costs submitted for reimbursement shall contain adequate source documentation, which may include but not be limited to cancelled checks, bank statements, Electronic Funds Transfer, paid bills and invoices, payrolls, time and attendance records, contract and subcontract award documents.

Construction Expense: The Sub-Recipient shall pre-audit bills, invoices, and/or charges submitted by the contractors and subcontractors and pay the contractors and subcontractors for approved bills, invoices, and/or charges. Sub-Recipient shall ensure that all contractor/subcontractor bills, invoices, and/or charges are legitimate and clearly identify the activities being performed and associated costs.

Project Management Expenses: The Sub-Recipient shall pre-audit source documentation such as payroll records, project time sheets, attendance logs, etc. Documentation shall be detailed information describing tasks performed, hours devoted to each task, and the hourly rate charged for each hour including enough information to calculate the hourly rates based on payroll records. Employee benefits shall be clearly shown.

The Division shall review all submitted requests for reimbursement for basic accuracy of information. Further, the Division shall ensure that no unauthorized work was completed prior to the approved project start date by verifying vendor and contractor invoices. The Division shall verify that reported costs were incurred in the performance of eligible work, that the approved work was completed, and that the mitigation measures are in compliance with the approved scope of work prior to processing any requests for reimbursement.

The Division in coordination with the Sub-Recipient, if applicable, shall conduct review and approval of any third party in-kind services. Quarterly reports shall be submitted by the Sub-Recipient and received by the Division at the times provided in this agreement prior to the processing of any reimbursement.

The Sub-Recipient shall submit to the Division requests for reimbursement of actual construction and managerial costs related to the project as identified in the project application, sealed engineering designs, and construction plans. The requests for reimbursement shall include:

- a) Contractor, subcontractor, and/or vendor invoices which clearly display dates of services performed, description of services performed, location of services performed, cost of services performed, name of service provider and any other pertinent information;
- b) Proof of payment from the Sub-Recipient to the contractor, subcontractor, and/or vendor for invoiced services;
- c) Clear identification of amount of costs being requested for reimbursement as well as costs being applied against the local match amount;

The Sub-Recipient's final request for reimbursement shall include the final construction project cost. Supporting documentation shall show that all contractors and subcontractors have been paid.

B) Deliverables:

Mitigation Activities consist of drainage improvements to Front Beach Road, located in Panama Beach City Florida, 32407; the installation of two (2) additional 54" RCP Culverts under Front Beach Road in the FDOT right of way, and modification of existing weir.

The completed project shall provide protection against a 25-year storm event.

Provided the Sub-Recipient performs in accordance with the Scope of Work outlined in this Agreement, the Division shall reimburse the Sub-Recipient based on the percentage of overall project completion.

PROJECT CONDITIONS AND REQUIREMENTS:

C) Engineering:

- 1) The Sub-Recipient shall submit to the Division an official letter stating that the project is 100% complete and ready for the Division's Final Inspection of the project.
- 2) The Sub-Recipient shall submit a signed and sealed final copy of the completed project's As-built drawings and all necessary supporting documentation, and provide a summary of all contract scope of work changes, if any.
- 3) The Sub-Recipient shall provide a copy of the Notice of commencement, and any local official Inspection Report and/or Final approval, as applicable.
- 4) The Sub-Recipient shall submit a certified letter of completion from Engineer of Record. The Sub-Recipient's Engineer of Record shall provide a formal certificate or letter affirming that the project has been completed in conformance with the approved project drawings, specifications, scope, and applicable codes.

D) Environmental:

- 1) Sub-Recipient shall follow all applicable state, local and federal laws regulations and requirements, and obtain (before starting project work) and comply with all required permits and approvals. Failure to obtain all appropriate federal, state, and local environmental permits and clearances may jeopardize federal funding. If project work is delayed for a year or more after the date of the categorical exclusion (CATEX), then coordination with and project review by regulatory agencies shall be redone.
- 2) Any change, addition or supplement to the approved Scope of Work that alters the project (including other work not funded by FEMA, but done substantially at the same time), regardless of the budget implications, shall require re-submission of the application to FEMA through the Division for National Environmental Policy Act (NEPA) re-evaluation before starting project work.
- 3) The Sub-Recipient shall monitor ground-disturbing activities during construction, and if any potential archeological resources are discovered, shall immediately cease construction in that area and notify the Division and FEMA.

If human remains or intact archaeological deposits are uncovered, work in the vicinity of the discovery shall stop immediately and all reasonable measures to avoid or minimize harm to the finds shall be taken. The Sub-Recipient shall ensure that archaeological discoveries are secured in place, that access to the sensitive area is restricted, and that all reasonable measures are taken to avoid further disturbance of the discoveries.

The Sub-Recipient's contractor shall provide immediate notice of such discoveries to the Sub-Recipient. The Sub-Recipient shall notify the Florida Division of Historic Resources, the Division's State Environmental Liaison Officer and FEMA within 24 hours of the discovery. Work in the vicinity

of the discovery may not resume until FEMA and the Division has completed consultation with SHPO, Tribes, and other consulting parties as necessary.

In the event that unmarked human remains are encountered during permitted activities, all work shall stop immediately and the proper authorities notified in accordance with *Florida Statutes, Section 872.05*.

- 4) The Sub-Recipient shall follow the special and general conditions stipulated in the USACE Nationwide permit (NWP) Number 14, #SAJ-2015-00956 (NW-LSL) regarding wetlands and the clear water act. Verification of compliance is required at project closeout.
- 5) Construction vehicles and equipment used for this project shall be maintained in good working order to minimize pollutant emissions.

Sub-Recipient.

Programmatic:

- 1) A change in the scope of work *must* be approved by the Division and FEMA in advance regardless of the budget implications.
- 2) The Sub-Recipient must notify the Division as soon as significant developments becomes known, such as delays or adverse conditions that might raise costs or delay completion, or favorable conditions allowing lower costs or earlier completion.
- 3) The Sub-Recipient must "obtain prior written approval for any budget revision which would result in a need for additional funds" [44 CFR 13(c)], from the Division and FEMA.
- 4) Project is approved with the condition that the enclosed list of deliverables shall be submitted, 30-days prior to the Period of Performance date, for review and approval by the Division; for submittal to FEMA for closeout.
- 5) Any extension of the Period of Performance shall be submitted to FEMA, 60 days prior to the expiration date. Therefore, any request for a Period of Performance Extension shall be in writing and submitted along with substantiation of new expiration date, and a new schedule of work, to the Division a minimum of seventy (70) days prior to the expiration date, for Division processing to FEMA.
- 6) The Sub-Recipient must avoid duplication of benefits between the HMGP and any other form of assistance, as required by Section 312 of the Stafford Act, and further clarification in 44 CFR 206.191.
- 7) If the Sub-Recipient is not the current titleholder of the affected properties, the Sub-Recipient shall provide documentation confirming the property acquisition and easement rights were obtained voluntarily. If condemnation or eminent domain is used to obtain easement rights, FEMA shall not pay for any associated costs or payments to the property owner. Furthermore, FEMA shall not consider it an eligible contribution to the non-Federal cost share requirement and shall not financially participate in that component of a project if land or easements are obtained involuntarily.

This is FEMA Project Number **4138-5-A**, is funded under HMGP-4138-DR-FL.

The project was awarded by FEMA on **October 27, 2017**; the Sub-Grantee Agreement was executed on February 19, 2015; and the Period of Performance for this project shall end on **October 31, 2019**.

FINANCIAL CONSEQUENCES:

If the Sub-Recipient fails to comply with any term of the award, the Division shall take one or more of the following actions, as appropriate in the circumstances:

- 1) Temporarily withhold cash payments pending correction of the deficiency by the Sub-Recipient;
- 2) Disallow all or part of the cost of the activity or action not in compliance;
- 3) Wholly or partly suspend or terminate the current award for the Sub-Recipient's program;
- 4) Withhold further awards for the program; or
- 5) Take other remedies that may be legally available.

SCHEDULE OF WORK:

Phase II-

State Contracting:	3 Months
Construction Plan/Technical Specifications:	3 Months
Bidding:	2 Months
Construction :	11 Months
Weather Delays:	2 Months
Final Inspection/Closeout:	3 Months
Total Period of Performance:	24 Months

BUDGET:

Line Item Budget*

Phase II	<u>Project Costs</u>	<u>Federal Share</u>
Materials:	\$257,465.00	\$257,465.00
Labor:	\$235,042.00	\$235,042.00
Management Cost:	\$25,918.00	\$25,918.00
Total Project Costs:	\$ 518,425.00	\$ 518,425.00

**Any line item amount in this Budget may be increased or decreased 10% or less without an amendment to this Agreement being required, so long as the overall amount of the funds obligated under this Agreement is not increased.*

Funding Summary

Federal Share:	\$518,425.00	(100.0%)
Total Project Cost:**	\$518,425.00	(100.0%)

The non-federal share will be met using a Global Match, which allows credit for similar eligible projects undertaken in the area that did not involve federal funds. The effect is that 100% of the project is covered by federal HMGP funds. FEMA project 4138-06-R, Bay County, Board of County Commissioners project provides the Global Match for the non-federal share for this project.

Attachment B

Program Statutes and Regulations

The parties to this Agreement and the Hazard Mitigation Grant Program (HMGP) are generally governed by the following statutes and regulations:

- (1) The Robert T. Stafford Disaster Relief and Emergency Assistance Act;
- (2) 44 CFR Parts 7, 9, 10, 13, 14, 17, 18, 25, 206, 220, and 221, and any other applicable FEMA policy memoranda and guidance documents;
- (3) State of Florida Administrative Plan for the Hazard Mitigation Grant Program;
- (4) Hazard Mitigation Assistance Guidance- February 27, 2015 Update; and
- (5) All applicable laws and regulations delineated in Attachment C of this Agreement.

In addition to the above statutes and regulations, the Sub-recipient must comply with the following:

The Sub-recipient shall fully perform the approved hazard mitigation project, as described in the Application and Attachment A (Budget and Scope of Work) attached to this Agreement, in accordance with approved scope of work indicated therein, the estimate of costs indicated therein, the allocation of funds indicated therein, and the terms and conditions of this Agreement. The Sub-recipient shall not deviate from the approved project and the terms and conditions of this Agreement. The Sub-recipient shall comply with any and all applicable codes and standards in performing work funded under this Agreement, and shall provide any appropriate maintenance and security for the project.

Any development permit issued by, or development activity undertaken by, the Sub-recipient and any land use permitted by or engaged in by the Sub-recipient, shall be consistent with the local comprehensive plan and land development regulations prepared and adopted pursuant to Chapter 163, Part II, Florida Statutes. Funds shall be expended for, and development activities and land uses authorized for, only those uses which are permitted under the comprehensive plan and land development regulations. The Sub-recipient shall be responsible for ensuring that any development permit issued and any development activity or land use undertaken is, where applicable, also authorized by the Water Management District, the Florida Department of Environmental Protection, the Florida Department of Health, the Florida Game and Fish Commission, and any Federal, State, or local environmental or land use permitting authority, where required. The Sub-recipient agrees that any repair or construction shall be in accordance with applicable standards of safety, decency, and sanitation, and in conformity with applicable codes, specifications and standards.

The Sub-recipient will provide and maintain competent and adequate engineering supervision at the construction site to ensure that the completed work conforms with the approved plans and specifications and will furnish progress reports and such other information to HMGP as may be required.

If the hazard mitigation project described in Attachment A includes an acquisition or relocation project, than the Sub-recipient shall ensure that, as a condition of funding under this Agreement, the owner of the affected real property shall record in the public records of the county where it is located the following covenants and restrictions, which shall run with and apply to any property acquired, accepted, or from which a structure will be removed pursuant to the project.

- (1) The property will be dedicated and maintained in perpetuity for a use that is compatible with open space, recreational, or wetlands management practices;

- (2) No new structure will be erected on property other than:
 - a. a public facility that is open on all sides and functionally related to a designed open space;
 - b. a restroom; or
- (3) A structure that the Director of the Federal Emergency Management Agency approves in writing before the commencement of the construction of the structure;
- (4) After the date of the acquisition or relocation no application for disaster assistance for any purpose will be made to any Federal entity and no disaster assistance will be provided for the property by any Federal source; and
- (5) If any of these covenants and restrictions is violated by the owner or by some third party with the knowledge of the owner, fee simple title to the Property described herein shall be conveyed to the Board of Trustees of the Internal Improvement Trust Fund of the State of Florida without further notice to the owner, its successors and assigns, and the owner, its successors and assigns shall forfeit all right, title and interest in and to the property.

HMGP Contract Manager will evaluate requests for cost overruns and submit to the regional Director written determination of cost overrun eligibility. Cost overruns shall meet Federal regulations set forth in 44 CFR 206.438(b).

The National Environmental Policy Act (NEPA) stipulates that additions or amendments to a HMGP Sub-recipient Scope of Work (SOW) shall be reviewed by all State and Federal agencies participating in the NEPA process.

As a reminder, the Sub-recipient must obtain prior approval from the State, before implementing changes to the approved project Scope of Work (SOW). Per the Uniform Administrative Requirements for Grants and Cooperative Agreements to State and Local Governments:

- (1) For Construction projects, the grantee must "obtain prior written approval for any budget revision which result in a need for additional funds" (44 CFR 13(c));
- (2) A change in the Scope of Work must be approved by FEMA in advance regardless of the budget implications; and
- (3) The Sub-recipient must notify the State as soon as significant developments become known, such as delays or adverse conditions that might raise costs or delay completion, or favorable conditions allowing lower cost or earlier completion. Any extensions of the period of performance must be submitted to FEMA sixty days prior to the project expiration date.

STATEMENT OF ASSURANCES

The Sub-recipient assures that it will comply with the following statutes and regulations to the extent applicable:

- (1) 53 Federal Register 8034
- (2) Federal Acquisition Regulations 31.2
- (3) Section 1352, Title 31, US Code
- (4) Chapter 473, Florida Statutes
- (5) Chapter 215, Florida Statutes
- (6) Section 768.28, Florida Statutes
- (7) Chapter 119, Florida Statutes
- (8) Section 216.181(6), Florida Statutes
- (9) Cash Management Improvement Act Of 1990
- (10) American with Disabilities Act
- (11) Section 112.061, Florida Statutes

- (12) Immigration and Nationality Act
- (13) Section 286.011, Florida Statutes
- (14) E.O. 12372 and Uniform Administrative Requirements for Grants and Cooperative Agreements 28 CFR, Part 66, Common Rule
- (15) Uniform Relocation Assistance and Real Property Acquisitions Act of 1970
- (16) Title I of the Omnibus Crime Control and Safe Streets Act of 1968
- (17) Juvenile Justice and Delinquency Prevention Act, or the Victims of Crime Act
- (18) Omnibus Crime Control and Safe Streets Act of 1968, as amended
- (19) 42 U.S.C. 3789(d) or Victims of Crime Act (as appropriate)
- (20) Section 504 of the Rehabilitation Act of 1973, as amended
- (21) Subtitle A, Title II of the Americans with Disabilities Act (ADA) (1990)
- (22) Department of Justice regulations on disability discrimination, 28 CFR, Part 35 and Part 39
- (23) 42 U.S.C. 5154a

Attachment C

Statement of Assurances

To the extent the following provisions apply to this Agreement, the Sub-recipient certifies that:

- (a) It possesses legal authority to enter into this Agreement and to carry out the proposed program;
- (b) Its governing body has duly adopted or passed as an official act of resolution, motion or similar action authorizing the execution of the hazard mitigation agreement with the Division of Emergency Management (DEM), including all understandings and assurances contained in it, and directing and authorizing the Sub-recipient's chief administrative officer or designee to act in connection with the application and to provide such additional information as may be required;
- (c) No member of or delegate to the Congress of the United States, and no Resident Commissioner, shall receive any share or part of this Agreement or any benefit. No member, officer, or employee of the Sub-recipient or its designees or agents, no member of the governing body of the locality in which this program is situated, and no other public official of the locality or localities who exercises any functions or responsibilities with respect to the program during his tenure or for one year after, shall have any interest, direct or indirect, in any contract or subcontract, or the proceeds, for work to be performed in connection with the program assisted under this Agreement. The Sub-recipient shall incorporate, in all contracts or subcontracts a provision prohibiting any interest pursuant to the purpose stated above;
- (d) All Sub-recipient contracts for which the State Legislature is in any part a funding source, shall contain language to provide for termination with reasonable costs to be paid by the Sub-recipient for eligible contract work completed prior to the date the notice of suspension of funding was received by the Sub-recipient. Any cost incurred after a notice of suspension or termination is received by the Sub-recipient may not be funded with funds provided under this Agreement unless previously approved in writing by the Division. All Sub-recipient contracts shall contain provisions for termination for cause or convenience and shall provide for the method of payment in such event;
- (e) It will comply with:
 - (1) Contract Work Hours and Safety Standards Act of 1962, 40 U.S.C. 327 et seq., requiring that mechanics and laborers (including watchmen and guards) employed on federally assisted contracts be paid wages of not less than one and one-half times their basic wage rates for all hours worked in excess of forty hours in a work week; and
 - (2) Federal Fair Labor Standards Act, 29 U.S.C. Section 201 et seq., requiring that covered employees be paid at least minimum prescribed wage, and also that they be paid one and one-half times their basic wage rates for all hours worked in excess of the prescribed work-week.
- (f) It will comply with
 - (1) Title VI of the Civil Rights Act of 1964 (P.L. 88-352), and the regulations issued pursuant thereto, which provides that no person in the United States shall on the grounds of race, color, or national origin, be excluded from participation in, be denied the benefits of, or be otherwise subjected to discrimination under any program or activity for which the Sub-recipient received Federal financial assistance and will immediately take any measures necessary to effectuate this assurance. If any real property or structure thereon is provided or improved with the aid of Federal financial assistance extended to the Sub-recipient, this assurance shall obligate the Sub-recipient, or in the case of any transfer of such property, any transferee, for the period during which the real property or structure is

- used for a purpose for which the Federal financial assistance is extended, or for another purpose involving the provision of similar services or benefits;
- (2) Any prohibition against discrimination on the basis of age under the Age Discrimination Act of 1975, as amended (42 U.S.C. 6101-6107) which prohibits discrimination on the basis of age or with respect to otherwise qualified handicapped individuals as provided in Section 504 of the Rehabilitation Act of 1973;
 - (3) Executive Order 11246, as amended by Executive Orders 11375 and 12086, and the regulations issued pursuant thereto, which provide that no person shall be discriminated against on the basis of race, color, religion, sex or national origin in all phases of employment during the performance of federal or federally assisted construction contracts; affirmative action to insure fair treatment in employment, upgrading, demotion, or transfer; recruitment or recruitment advertising; layoff/termination, rates of pay or other forms of compensation; and election for training and apprenticeship;
- (g) It will establish safeguards to prohibit employees from using positions for a purpose that is or gives the appearance of being motivated by a desire for private gain for themselves or others, particularly those with whom they have family, business, or other ties pursuant to Section 112.313 and Section 112.3135, Florida Statutes;
 - (h) It will comply with the Anti-Kickback Act of 1986, 41 U.S.C. Section 51 which outlaws and prescribes penalties for "kickbacks" of wages in federally financed or assisted construction activities;
 - (i) It will comply with the provisions of 18 U.S.C. 594, 598, 600-605 (further known as the Hatch Act) which limits the political activities of employees;
 - (j) It will comply with the flood insurance purchase and other requirements of the Flood Disaster Protection Act of 1973, as amended, 42 U.S.C. 4002-4107, including requirements regarding the purchase of flood insurance in communities where such insurance is available as a condition for the receipt of any Federal financial assistance for construction or acquisition purposes for use in any area having special flood hazards. The phrase "Federal financial assistance" includes any form of loan, grant, guaranty, insurance payment, rebate, subsidy, disaster assistance loan or grant, or any other form of direct or indirect Federal assistance;
- For sites located within Special Flood Hazard Areas (SFHA), the Sub-recipient must include a FEMA Model Acknowledgement of Conditions of Mitigation of Property in a Special Flood Hazard Area with FEMA Grant Funds executed by the title holder with the closeout request verifying that certain SFHA requirements were satisfied on each of the properties. The Model Acknowledgement can be found at www.fema.gov/government/grant/sfha_conditions.shtml
- (k) It will require every building or facility (other than a privately owned residential structure) designed, constructed, or altered with funds provided under this Agreement to comply with the "Uniform Federal Accessibility Standards," (AS) which is Appendix A to 41 CFR Section 101-19.6 for general type buildings and Appendix A to 24 CFR, Part 40 for residential structures. The Sub-recipient will be responsible for conducting inspections to ensure compliance with these specifications by the contractor;
 - (l) It will, in connection with its performance of environmental assessments under the National Environmental Policy Act of 1969, comply with Section 106 of the National Historic Preservation Act of 1966 (U.S.C. 470), Executive Order 11593, 24 CFR, Part 800, and the Preservation of Archaeological and Historical Data Act of 1966 (16 U.S.C. 469a-1, et seq.) by:
 - (1) Consulting with the State Historic Preservation Office to identify properties listed in or eligible for inclusion in the National Register of Historic Places that are subject to adverse effects (see 36 CFR, Section 800.8) by the proposed activity; and

- (2) Complying with all requirements established by the State to avoid or mitigate adverse effects upon such properties.
- (3) Abiding by the terms and conditions of the "**Programmatic Agreement Among the Federal Emergency Management Agency, the Florida State Historic Preservation Office, the Florida Division of Emergency Management and the Advisory Council on Historic Preservation, (PA)**" which addresses roles and responsibilities of Federal and State entities in implementing Section 106 of the National Historic Preservation Act (NHPA), 16 U.S.C. 470(f), and implementing regulations in 36 CFR, Part 800.
- (4) When any of the Sub-recipient's projects funded under this Agreement may affect a historic property, as defined in 36 CFR, Part 800 (2)(e), the Federal Emergency Management Agency (FEMA) may require the Sub-recipient to review the eligible scope of work in consultation with the State Historic Preservation Office (SHPO) and suggest methods of repair or construction that will conform with the recommended approaches set out in the **Secretary of Interior's Standards for Rehabilitation and Guidelines for Rehabilitating Historic Buildings 1992 (Standards)**, the **Secretary of the Interior's Guidelines for Archeological Documentation (Guidelines)** (48 Federal Register 44734-37), or any other applicable Secretary of Interior standards. If FEMA determines that the eligible scope of work will not conform with the **Standards**, the Sub-recipient agrees to participate in consultations to develop, and after execution by all parties, to abide by, a written agreement that establishes mitigation and recondition measures, including but not limited to, impacts to archeological sites, and the salvage, storage, and reuse of any significant architectural features that may otherwise be demolished.
- (5) The Sub-recipient agrees to notify FEMA and the Division if any project funded under this Agreement will involve ground disturbing activities, including, but not limited to: subsurface disturbance; removal of trees; excavation of footings and foundations, and installation of utilities (such as water, sewer, storm drains, electrical, gas, leach lines and septic tanks) except where these activities are restricted solely to areas previously disturbed by the installation, replacement or maintenance of such utilities. FEMA will request the SHPO's opinion on the potential that archeological properties may be present and be affected by such activities. The SHPO will advise the Sub-recipient on any feasible steps to be accomplished to avoid any National Register eligible archeological property or will make recommendations for the development of a treatment plan for the recovery or archeological data from the property.

If the Sub-recipient is unable to avoid the archeological property, develop, in consultation with SHPO, a treatment plan consistent with the **Guidelines** and take into account the Advisory Council on Historic Preservation (Council) publication "Treatment of Archeological Properties". The Sub-recipient shall forward information regarding the treatment plan to FEMA, the SHPO and the Council for review. If the SHPO and the Council do not object within 15 calendar days of receipt of the treatment plan, FEMA may direct the Sub-recipient to implement the treatment plan. If either the Council or the SHPO object, Sub-recipient shall not proceed with the project until the objection is resolved.
- (6) The Sub-recipient shall notify the Division and FEMA as soon as practicable: (a) of any changes in the approved scope of work for a National Register eligible or listed property; (b) of all changes to a project that may result in a supplemental DSR or modify a HMGP project for a National Register eligible or listed property; (c) if it appears that a project funded under this Agreement will affect a previously unidentified property that may be eligible for inclusion in the National Register or affect a known historic property in an unanticipated manner. The Sub-recipient acknowledges that FEMA may require the Sub-recipient to stop construction in the vicinity of the discovery of a previously unidentified property that may eligible for inclusion in the National Register or upon learning that construction may affect a known historic property in an unanticipated manner. The Sub-recipient further acknowledges that FEMA may require the Sub-recipient to take all

reasonable measures to avoid or minimize harm to such property until FEMA concludes consultation with the SHPO. The Sub-recipient also acknowledges that FEMA will require, and the Sub-recipient shall comply with, modifications to the project scope of work necessary to implement recommendations to address the project and the property.

- (7) The Sub-recipient acknowledges that, unless FEMA specifically stipulates otherwise, it shall not receive funding for projects when, with intent to avoid the requirements of the PA or the NHPA, the Sub-recipient intentionally and significantly adversely affects a historic property, or having the legal power to prevent it, allowed such significant adverse affect to occur.
- (m) It will comply with Title IX of the Education Amendments of 1972, as amended (20 U.S.C. 1681-1683 and 1685-1686) which prohibits discrimination on the basis of sex;
- (n) It will comply with the Comprehensive Alcohol Abuse and Alcoholism Prevention, Treatment and Rehabilitation Act of 1970, (42 U.S.C. 4521-45-94) relating to nondiscrimination on the basis of alcohol abuse or alcoholism;
- (o) It will comply with 523 and 527 of the Public Health Service Act of 1912 (42 U.S.C. 290 dd-3 and 290 ee-3), as amended, relating to confidentiality of alcohol and drug abuse patient records;
- (p) It will comply with Lead-Based Paint Poison Prevention Act (42 U.S.C. 4821 et seq.) which prohibits the use of lead based paint in construction of rehabilitation or residential structures;
- (q) It will comply with the Energy Policy and Conservation Act (P.L. 94-163; 42 U.S.C. 6201-6422), and the provisions of the State Energy Conservation Plan adopted pursuant thereto;
- (r) It will comply with the Laboratory Animal Welfare Act of 1966, (7 U.S.C. 2131-2159), pertaining to the care, handling, and treatment of warm blooded animals held for research, teaching, or other activities supported by an award of assistance under this Agreement;
- (s) It will comply with Title VIII of the Civil Rights Act of 1968, (42 U.S.C 2000c and 42 U.S.C. 3601-3619), as amended, relating to non-discrimination in the sale, rental, or financing of housing, and Title VI of the Civil Rights Act of 1964 (P.L. 88-352), which prohibits discrimination on the basis of race, color or national origin;
- (t) It will comply with the Clean Air Act of 1955, as amended, 42 U.S.C. 7401-7642;
- (u) It will comply with the Clean Water Act of 1977, as amended, 42 U.S.C. 7419-7626
- (v) It will comply with the endangered Species Act of 1973, 16 U.S.C. 1531-1544;
- (w) It will comply with the Intergovernmental Personnel Act of 1970, 42 U.S.C. 4728-4763;
- (x) It will assist the awarding agency in assuring compliance with the National Historic Preservation Act of 1966, as amended, 16 U.S.C. 270;
- (y) It will comply with environmental standards which may be prescribed pursuant to the National Environmental Policy Act of 1969, 42 U.S.C. 4321-4347;
- (z) It will assist the awarding agency in assuring compliance with the Preservation of Archeological and Historical Preservation Act of 1966, 16 U.S.C. 469a, et seq.;
- (aa) It will comply with the Rehabilitation Act of 1973, Section 504, 29 U.S.C. 794, regarding non-discrimination;

- (bb) It will comply with the environmental standards which may be prescribed pursuant to the Safe Drinking Water Act of 1974, 42 U.S.C. 300f-300j, regarding the protection of underground water sources;
- (cc) It will comply with the requirements of Titles II and III of the Uniform Relocation Assistance and Property Acquisition Policies Act of 1970, 42 U.S.C. 4621-4638, which provide for fair and equitable treatment of persons displaced or whose property is acquired as a result of Federal or Federally assisted programs;
- (dd) It will comply with the Wild and Scenic Rivers Act of 1968, 16 U.S.C. 1271-1287, related to protecting components or potential components of the national wild and scenic rivers system;
- (ee) It will comply with the following Executive Orders: EO 11514 (NEPA); EO 11738 (violating facilities); EO 11988 (Floodplain Management); EO 11990 (Wetlands); and EO 12898 (Environmental Justice);
- (ff) It will comply with the Coastal Barrier Resources Act of 1977, 16 U.S.C. 3510;
- (gg) It will assure project consistency with the approved State program developed under the Coastal Zone Management Act of 1972, 16 U.S.C. 1451-1464; and
- (hh) It will comply with the Fish and Wildlife Coordination Act of 1958, 16 U.S.C. 661-666.
- (ii) With respect to demolition activities, it will:
 - (1) Create and make available documentation sufficient to demonstrate that the Sub-recipient and its demolition contractor have sufficient manpower and equipment to comply with the obligations as outlined in this Agreement.
 - (2) Return the property to its natural state as though no improvements had ever been contained thereon.
 - (3) Furnish documentation of all qualified personnel, licenses and all equipment necessary to inspect buildings located in the Sub-recipient's jurisdiction to detect the presence of asbestos and lead in accordance with requirements of the U.S. Environmental Protection Agency, the Florida Department of Environmental Protection and the County Health Department.
 - (4) Provide documentation of the inspection results for each structure to indicate:
 - a. Safety Hazard Present
 - b. Health Hazards Present
 - c. Hazardous Materials Present
 - (5) Provide supervision over contractors or employees employed by the Sub-recipient to remove asbestos and lead from demolished or otherwise applicable structures.
 - (6) Leave the demolished site clean, level and free of debris.
 - (7) Notify the Division promptly of any unusual existing condition which hampers the contractor's work.
 - (8) Obtain all required permits.
 - (9) Provide addresses and marked maps for each site where water wells and septic tanks are to be closed along with the number of wells and septic tanks located on each site. Provide documentation of closures.
 - (10) Comply with mandatory standards and policies relating to energy efficiency which are contained in the State Energy Conservation Plan issued in compliance with the Energy Policy and Conservation Act (Public Law 94-163).

- (11) Comply with all applicable standards, orders, or requirements issued under Section 112 and 306 of the Clean Air Act (42 U.S.C. 1857h), Section 508 of the Clean Water Act (33 U.S.C. 1368), Executive Order 11738, and the U.S. Environmental Protection Agency regulations (40 CFR, Part 15 and 61). This clause shall be added to any subcontracts.
- (12) Provide documentation of public notices for demolition activities.

Attachment D

DIVISION OF EMERGENCY MANAGEMENT

**REQUEST FOR ADVANCE OR REIMBURSEMENT OF
HAZARD MITIGATION ASSISTANCE PROGRAM FUNDS**

SUB-RECIPIENT NAME: City of Panama City Beach

REMIT ADDRESS: _____

CITY, STATE, ZIP CODE: _____

PAYMENT #: _____ CONTRACT #: 18HM-9J-01-13-02-XXX

FEMA TRACKING #: 4138-5-A INVOICE PERIOD: _____ to _____

Eligible Amount 100%	Obligated Federal 75%	Obligated Non-Federal 25%	Previous Payments	Current Request	DEM Use Only	
					Approved	Comments

TOTAL CURRENT REQUEST: \$ _____

By signing this report, I certify to the best of my knowledge and belief that the report is true, complete, and accurate, and the expenditures, disbursements and cash receipts are for the purposes and objectives set forth in the terms and conditions of the Federal award. I am aware that any false, fictitious, or fraudulent information, or the omission of any material fact, may subject me to criminal, civil or administrative penalties for fraud, false statements, false claims or otherwise. (U.S. Code Title 18, Section 1001 and Title 31, Sections 3729-3730 and 3801-3812.

SUB-RECIPIENT SIGNATURE: _____

NAME AND TITLE: _____ DATE: _____

APPROVED PROJECT TOTAL	\$ _____	GOVERNOR'S AUTHORIZED REPRESENTATIVE
ADMINISTRATIVE COST	\$ _____	
APPROVED FOR PAYMENT	\$ _____	DATE _____

**Attachment D
(Continued)**

DIVISION OF EMERGENCY MANAGEMENT

**SUMMARY OF DOCUMENTATION IN SUPPORT OF AMOUNT
CLAIMED FOR ELIGIBLE DISASTER WORK UNDER THE
HAZARD MITIGATION ASSISTANCE PROGRAM**

SUB-RECIPIENT: City of Panama City Beach DISASTER #: 4138-5-A

CONTRACT #: 18HM-9J-01-13-02-XXX FEMA TRACKING #: _____

Sub-Recipient's Reference No. (Warrant, Voucher, Claim check, or Schedule No.)	Date of delivery of articles, completion of work or performance services.	<u>DOCUMENTATION</u> List documentation (applicant's payroll, material out of applicant's stock, applicant owned equipment and name of vendor or contractor) by category and line item in the approved project application and give a brief description of the articles or services.	Sub-Recipient's Eligible Costs 100%
TOTAL:			

Attachment E

JUSTIFICATION OF ADVANCE PAYMENT

SUB-RECIPIENT: _____

If you are requesting an advance, indicate same by checking the box below.

<input type="checkbox"/> ADVANCE REQUESTED Advance payment of \$_____ is requested. Balance of payments will be made on a reimbursement basis. These funds are needed to pay staff, award benefits to clients, duplicate forms and purchase start-up supplies and equipment. We would not be able to operate the program without this advance.
--

If you are requesting an advance, complete the following chart and line item justification below.

ESTIMATED EXPENSES

BUDGET CATEGORY/LINE ITEMS (list applicable line items)	20__-20__ Anticipated Expenditures for the First Three Months of Contract
For Example ADMINISTRATIVE COSTS (Include Secondary Administration)	
For Example PROGRAM EXPENSES	
TOTAL EXPENSES	

LINE ITEM JUSTIFICATION (For each line item, provide a detailed justification explaining the need for the cash advance. The justification must include supporting documentation that clearly shows the advance will be expended within the first ninety (90) days of the contract term. Support documentation should include quotes for purchases, delivery timelines, salary and expense projections, etc. to provide the Division reasonable and necessary support that the advance will be expended within the first ninety (90) days of the contract term. Any advance funds not expended within the first ninety (90) days of the contract term shall be returned to the Division Cashier, 2555 Shumard Oak Boulevard, Tallahassee, Florida 32399, within thirty (30) days of receipt, along with any interest earned on the advance).

Attachment F

DIVISION OF EMERGENCY MANAGEMENT
HAZARD MITIGATION GRANT PROGRAM
QUARTERLY REPORT FORM

RECEIPT _____ PROJECT #: 4138-5-A

PROJECT TYPE: Drainage Improvement Project CONTRACT#: 18HM-9J-01-13-02-XXX

DISASTER NUMBER: 4138-5-A QUARTER ENDING: _____

Provide amount of advance funds disbursed for period (if applicable): \$ _____

Provide reimbursement projections for this project:

July-Sep 20 \$ _____ Oct-Dec 20 \$ _____ Jan-Mar 20 \$ _____ Apr-June 20 \$ _____
July-Sep 20 \$ _____ Oct-Dec 20 \$ _____ Jan-Mar 20 \$ _____ Apr-June 20 \$ _____

Percentage of Work Completed (may be confirmed by state inspector's): _____ %

Project Proceeding on Schedule: Yes No

Describe milestones achieved during this quarter:

Provide a schedule for the remainder of work to project completion:

Describe problems or circumstances affecting completion date, milestones, scope of work, and cost:

Cost Status: : Cost Unchanged Under Budget Over Budget

Additional Comments/Elaboration:

NOTE: Division of Emergency Management (DEM) staff may perform interim inspections and/or audits at any time. Events may occur between quarterly reports, which have significant impact upon your project, such as, anticipated overruns, changes in scope of work, etc. Please contact the Division as soon as these conditions become known, otherwise you may be found non-compliant with your subgrant award.

Name and Phone Number of Person Completing This Form _____

Attachment G

Warranties and Representations

Financial Management

The Sub-Recipient's financial management system must comply with 2 C.F.R. §200.302.

Procurements

Any procurement undertaken with funds authorized by this Agreement must comply with the requirements of 2 C.F.R. §200, Part D—Post Federal Award Requirements—Procurement Standards (2 C.F.R. §§200.317 through 200.326).

Business Hours

The Sub-Recipient shall have its offices open for business, with the entrance door open to the public, and at least one employee on site, from: 8:00 AM - 5:00PM, Monday Thru Friday, as applicable.

Licensing and Permitting

All subcontractors or employees hired by the Sub-Recipient shall have all current licenses and permits required for all of the particular work for which they are hired by the Sub-Recipient.

Attachment H

**Certification Regarding
Debarment, Suspension, Ineligibility
And Voluntary Exclusion**

Contractor Covered Transactions

- (1) The prospective subcontractor of the Sub-recipient, _____, certifies, by submission of this document, that neither it nor its principals is presently debarred, suspended, proposed for debarment, declared ineligible, or voluntarily excluded from participation in this transaction by any Federal department or agency.
- (2) Where the Sub-recipient's subcontractor is unable to certify to the above statement, the prospective contract shall attach an explanation to this form.

CONTRACTOR

By: _____
Signature

Name and Title

Street Address

City, State, Zip

Date

CITY OF PANAMA CITY BEACH
Sub-Recipient's Name

18HM-9J-01-13-02-XXX
DEM Contract Number

4138-5-A
FEMA Project Number

Attachment I

**FEDERAL FUNDING ACCOUNTABILITY AND TRANSPARENCY ACT
INSTRUCTIONS AND WORKSHEET**

PURPOSE: The Federal Funding Accountability and Transparency Act (FFATA) was signed on September 26, 2006. The intent of this legislation is to empower every American with the ability to hold the government accountable for each spending decision. The FFATA legislation requires information on federal awards (federal assistance and expenditures) be made available to the public via a single, searchable website, which is <http://www.usaspending.gov/>.

The FFATA Sub-award Reporting System (FSRS) is the reporting tool the Florida Division of Emergency Management ("FDEM" or "Division") must use to capture and report sub-award and executive compensation data regarding first-tier sub-awards that obligate \$25,000 or more in Federal funds (excluding Recovery funds as defined in section 1512(a) (2) of the American Recovery and Reinvestment Act of 2009, Pub. L. 111-5).

Note: This "Instructions and Worksheet" is meant to explain the requirements of the FFATA and give clarity to the FFATA Form distributed to sub-awardees for completion. All pertinent information below should be filled out, signed, and returned to the project manager.

ORGANIZATION AND PROJECT INFORMATION

The following information must be provided to the FDEM prior to the FDEM's issuance of a sub-award (Agreement) that obligates \$25,000 or more in federal funds as described above. Please provide the following information and return the signed form to the Division as requested.

PROJECT #: 4138-5-A

FUNDING AGENCY: Federal Emergency Management Agency

AWARD AMOUNT: \$518,425.00

OBLIGATION/ACTION DATE: October 27, 2017

SUBAWARD DATE (if applicable): _____

DUNS#: 18095984

DUNS# +4: _____

*If your company or organization does not have a DUNS number, you will need to obtain one from Dun & Bradstreet at 866-705-5711 or use the web form (<http://fedgov.dnb.com/webform>). The process to request a DUNS number takes about ten minutes and is free of charge.

BUSINESS NAME: _____
DBA NAME (IF APPLICABLE): _____
PRINCIPAL PLACE OF BUSINESS ADDRESS: _____
ADDRESS LINE 1: _____
ADDRESS LINE 2: _____
ADDRESS LINE 3: _____
CITY _____ STATE _____ ZIP CODE+4** _____

PARENT COMPANY DUNS# (if applicable): _____
CATALOG OF FEDERAL DOMESTIC ASSISTANCE (CFDA#): _____

DESCRIPTION OF PROJECT (Up to 4000 Characters)

As a Hazard Mitigation Grant Program project, the Sub-Recipient proposes to improve the drainage at Front Beach Road located about 0.1 miles east from intersection of South Thomas Drive and Front Beach Road in Panama City Beach, Florida 32407.

The Phase II – Construction scope of work proposed drainage includes the installation of two (2) additional 54" Reinforced Concrete Pipe (RCP) Culverts under Front Beach Road in the Florida Department of Transportation (FDOT) right of way, and modification of existing weir. The project shall also include new FDOT index 250 Concrete Headwalls, major utility relocations and stabilization sod to complete the project.

When completed the project shall provide protection against a 25-year storm event.
Sub-Recipient.

Verify the approved project description above, if there is any discrepancy, please contact the project manager.

PRINCIPAL PLACE OF PROJECT PERFORMANCE (IF DIFFERENT THAN PRINCIPAL PLACE OF BUSINESS):

ADDRESS LINE 1: _____
ADDRESS LINE 2: _____
ADDRESS LINE 3: _____
CITY _____ STATE _____ ZIP CODE+4** _____

CONGRESSIONAL DISTRICT FOR PRINCIPAL PLACE OF PROJECT PERFORMANCE:

**Providing the Zip+4 ensures that the correct Congressional District is reported.

EXECUTIVE COMPENSATION INFORMATION:

1. In your business or organization's previous fiscal year, did your business or organization (including parent organization, all branches, and all affiliates worldwide) receive (a) 80 percent or more of your annual gross revenues from Federal procurement contracts (and subcontracts) and Federal financial assistance (e.g. loans, grants, subgrants, and/or cooperative agreements, etc.)

subject to the Transparency Act, as defined at 2 CFR 170.320; , (b) \$25,000,000 or more in annual gross revenues from U.S. Federal procurement contracts (and subcontracts) and Federal financial assistance (e.g. loans, grants, subgrants, and/or cooperative agreements, etc.) subject to the Transparency Act?

Yes No

If the answer to Question 1 is "Yes," continue to Question 2. If the answer to Question 1 is "No", move to the signature block below to complete the certification and submittal process.

2. Does the public have access to information about the compensation of the executives in your business or organization (including parent organization, all branches, and all affiliates worldwide) through periodic reports filed under section 13(a) or 15(d) of the Securities Exchange Act of 1934 (15 U.S.C. 78m(a), 78o(d)) Section 6104 of the Internal Revenue Code of 1986?

Yes No

If the answer to Question 2 is "Yes," move to the signature block below to complete the certification and submittal process. [Note: Securities Exchange Commission information should be accessible at <http://www.sec.gov/answers/excomp.htm>. Requests for Internal Revenue Service (IRS) information should be directed to the local IRS for further assistance.]

If the answer to Question 2 is "No" FFATA reporting is required. Provide the information required in the "TOTAL COMPENSATION CHART FOR MOST RECENTLY COMPLETED FISCAL YEAR" appearing below to report the "Total Compensation" for the five (5) most highly compensated "Executives", in rank order, in your organization. For purposes of this request, the following terms apply as defined in 2 CFR Ch. 1 Part 170 Appendix A:

"Executive" is defined as "officers, managing partners, or other employees in management positions".

"Total Compensation" is defined as the cash and noncash dollar value earned by the executive during the most recently completed fiscal year and includes the following:

- i. Salary and bonus.
- ii. Awards of stock, stock options, and stock appreciation rights. Use the dollar amount recognized for financial statement reporting purposes with respect to the fiscal year in accordance with the Statement of Financial Accounting Standards No. 123 (Revised 2004) (FAS 123R), Shared Based Payments.
- iii. Earnings for services under non-equity incentive plans. This does not include group life, health, hospitalization or medical reimbursement plans that do not discriminate in favor of executives, and are available generally to all salaried employees.
- iv. Change in pension value. This is the change in present value of defined benefit and actuarial pension plans.
- v. Above-market earnings on deferred compensation which is not tax-qualified.
- vi. Other compensation, if the aggregate value of all such other compensation (e.g. severance, termination payments, value of life insurance paid on behalf of the employee, perquisites or property) for the executive exceeds \$10,000.

TOTAL COMPENSATION CHART FOR MOST RECENTLY COMPLETED FISCAL YEAR

(Date of Fiscal Year Completion _____)

Rank (Highest to Lowest)	Name (Last, First, MI)	Title	Total Compensation for Most Recently Completed Fiscal Year
1			
2			
3			
4			
5			

THE UNDERSIGNED CERTIFIES THAT ON THE DATE WRITTEN BELOW, THE INFORMATION PROVIDED HEREIN IS ACCURATE.

SIGNATURE: _____

NAME AND TITLE: _____

DATE: _____

Attachment J

Mandatory Contract Provisions

Provisions:

Any contract or subcontract funded by this Agreement must contain the applicable provisions outlined in Appendix II to 2 C.F.R. Part 200. It is the responsibility of the sub-recipient to include the required provisions. The Division provides the following list of sample provisions that may be required:

OMB Guidance

Pt. 200, App. II

(D) Davis-Bacon Act, as amended (40 U.S.C. 3141-3148). When required by Federal program legislation, all prime construction contracts in excess of \$2,000 awarded by non-Federal entities must include a provision for compliance with the Davis-Bacon Act (40 U.S.C. 3141-3144, and 3146-3149), as supplemented by Department of Labor regulations (29 CFR Part 5, "Labor Standards Provisions Applicable to Contracts Covering Federally Financed and Assisted Construction"). In accordance with the statute, contractors must be required to pay wages to laborers and mechanics at a rate not less than the prevailing wages specified in a wage determination made by the Secretary of Labor. In addition, contractors must be required to pay wages not less than once a week. The non-Federal entity must place a copy of the current prevailing wage determination issued by the Department of Labor in each solicitation. The decision to award a contract or subcontract must be conditioned upon the acceptance of the wage determination. The non-Federal entity must report all suspected or reported violations to the Federal awarding agency. The contracts must also include a provision for compliance with the Copeland "Anti-Kickback" Act (40 U.S.C. 3145), as supplemented by Department of Labor regulations (29 CFR Part 3, "Contractors and Subcontractors on Public Building or Public Work Financed in Whole or in Part by Loans or Grants from the United States"). The Act provides that each contractor or sub-recipient must be prohibited from inducing, by any means, any person employed in the construction, completion, or repair of public work, to give up any part of the compensation to which he or she is otherwise entitled. The non-Federal entity must report all suspected or reported violations to the Federal awarding agency.

(E) Contract Work Hours and Safety Standards Act (40 U.S.C. 3701-3708). Where applicable, all contracts awarded by the non-Federal entity in excess of \$100,000 that involve the employment of mechanics or laborers must include a provision for compliance with 40 U.S.C. 3702 and 3704, as supplemented by Department of Labor regulations (29 CFR Part 5). Under 40 U.S.C. 3702 of the Act, each contractor must be required to compute the wages of every mechanic and laborer on the basis of a standard work week of 40 hours. Work in excess of the standard work week is permissible provided that the worker is compensated at a rate of not less than one and a half times the basic rate of pay for all hours worked in excess of 40 hours in the work week. The requirements of 40 U.S.C. 3704 are applicable to construction work and provide that no laborer or mechanic must be required to work in surroundings or under working conditions which are unsanitary, hazardous or dangerous. These requirements do not apply to the purchases of supplies or

materials or articles ordinarily available on the open market, or contracts for transportation or transmission of intelligence.

(F) Rights to Inventions Made Under a Contract or Agreement. If the Federal award meets the definition of "funding agreement" under 37 CFR §401.2 (a) and the recipient or subrecipient wishes to enter into a contract with a small business firm or nonprofit organization regarding the substitution of parties, assignment or performance of experimental, developmental, or research work under that "funding agreement," the recipient or subrecipient must comply with the requirements of 37 CFR Part 401, "Rights to Inventions Made by Nonprofit Organizations and Small Business Firms Under Government Grants, Contracts and Cooperative Agreements," and any implementing regulations issued by the awarding agency.

(G) Clean Air Act (42 U.S.C. 7401-7671q.) and the Federal Water Pollution Control Act (33 U.S.C. 1251-1387), as amended—Contracts and subgrants of amounts in excess of \$150,000 must contain a provision that requires the non-Federal award to agree to comply with all applicable standards, orders or regulations issued pursuant to the Clean Air Act (42 U.S.C. 7401-7671q) and the Federal Water Pollution Control Act as amended (33 U.S.C. 1251-1387). Violations must be reported to the Federal awarding agency and the Regional Office of the Environmental Protection Agency (EPA).

(H) Mandatory standards and policies relating to energy efficiency which are contained in the state energy conservation plan issued in compliance with the Energy Policy and Conservation Act (42 U.S.C. 6201).

(I) Debarment and Suspension (Executive Orders 12549 and 12689)—A contract award (see 2 CFR 180.220) must not be made to parties listed on the governmentwide Excluded Parties List System in the System for Award Management (SAM). In accordance with the OMB guidelines at 2 CFR 180 that implement Executive Orders 12549 (3 CFR Part 1096 Comp., p. 189) and 12689 (3 CFR Part 1089 Comp., p. 235), "Debarment and Suspension," The Excluded Parties List System in SAM contains the names of parties debarred, suspended, or otherwise excluded by agencies, as well as parties declared ineligible under statutory or regulatory authority other than Executive Order 12549.

(J) Byrd Anti-Lobbying Amendment (31 U.S.C. 1352)—Contractors that apply or bid for an award of \$100,000 or more must file the required certification. Each tier certifies to the tier above that it will not and has not used Federal appropriated funds to pay any person or organization for influencing or attempting to influence an officer or employee of any agency, a member of Congress, officer or employee of Congress, or an employee of a member of Congress in connection with obtaining any Federal contract, grant or any

other award covered by 31 U.S.C. 1352. Each tier must also disclose any lobbying with non-Federal funds that takes place in connection with obtaining any Federal award. Such disclosures are forwarded from tier to tier up to the non-Federal award.

(K) See §200.322 Procurement of recovered materials.

APPENDIX III TO PART 200—INDIRECT (F&A) COSTS IDENTIFICATION AND ASSIGNMENT, AND RATE DETERMINATION FOR INSTITUTIONS OF HIGHER EDUCATION (IHES)

A. GENERAL

This appendix provides criteria for identifying and computing indirect (or indirect (F&A)) rates at IHES (Institutions). Indirect (F&A) costs are those that are incurred for common or joint objectives and therefore cannot be identified readily and specifically with a particular sponsored project, an instructional activity, or any other institutional activity. See subsection B.1. Definition of Facilities and Administration, for a discussion of the components of indirect (F&A) costs.

1. Major Functions of an Institution

Refers to instruction, organized research, other sponsored activities and other institutional activities as defined in this section:

a. *Instruction* means the teaching and training activities of an institution. Except for research training as provided in subsection b, this term includes all teaching and training activities, whether they are offered for credits toward a degree or certificate or on a non-credit basis, and whether they are offered through regular academic departments or separate divisions, such as a summer school division or an extension division. Also considered part of this major function are departmental research, and, where agreed to, university research.

(1) *Sponsored instruction and training* means specific instructional or training activity established by grant, contract, or cooperative agreement. For purposes of the cost principles, this activity may be considered a major function even though an institution's accounting treatment may include it in the instruction function.

(2) *Departmental research* means research, development and scholarly activities that are not organized research and, consequently, are not separately budgeted and accounted for. Departmental research, for purposes of this document, is not considered as a major function, but as a part of the instruction function of the institution.

b. *Organized research* means all research and development activities of an institution that are separately budgeted and accounted for. It includes:

(1) *Sponsored research* means all research and development activities that are sponsored by Federal and non-Federal agencies and organizations. This term includes activities involving the training of individuals in research techniques (commonly called research training) where such activities utilize the same facilities as other research and development activities and where such activities are not included in the instruction function.

(2) *University research* means all research and development activities that are separately budgeted and accounted for by the institution under an internal application of institutional funds. University research, for purposes of this document, must be combined with sponsored research under the function of organized research.

c. *Other sponsored activities* means programs and projects financed by Federal and non-Federal agencies and organizations which involve the performance of work other than instruction and organized research. Examples of such programs and projects are health service projects and community service programs. However, when any of these activities are undertaken by the institution without outside support, they may be classified as other institutional activities.

d. *Other institutional activities* means all activities of an institution except for instruction, departmental research, organized research, and other sponsored activities, as defined in this section; indirect (F&A) cost activities identified in this Appendix paragraph B. Identification and assignment of indirect (F&A) costs; and specialized services facilities described in §200.468 Specialized service facilities of this Part.

Examples of other institutional activities include operation of residence halls, dining halls, hospitals and clinics, student unions, intercollegiate athletics, bookstores, faculty housing, student apartments, guest houses, chapels, theaters, public museums, and other similar auxiliary enterprises. This definition also includes any other categories of activities, costs of which are "unallowable" to Federal awards, unless otherwise indicated in an award.

2. Criteria for Distribution

a. *Base period.* A base period for distribution of indirect (F&A) costs is the period during which the costs are incurred. The base period normally should coincide with the fiscal year established by the institution, but in any event the base period should be so selected as to avoid inequities in the distribution of costs.

b. *Need for cost groupings.* The overall objective of the indirect (F&A) cost allocation process is to distribute the indirect (F&A) costs described in Section B. Identification and assignment of indirect (F&A) costs, to

REGULAR AGENDA

ITEM 9*



CITY OF PANAMA CITY BEACH AGENDA ITEM SUMMARY

1. DEPARTMENT MAKING REQUEST/NAME:
CRA/Kelly Jenkins

2. MEETING DATE:
12/14/2017

3. REQUESTED MOTION/ACTION:
Approve Change Order #11 and future contingencies for the Front Beach Road CRA Segment 2 project.

4. AGENDA
PRESENTATION
PUBLIC HEARING
CONSENT
REGULAR

5. IS THIS ITEM BUDGETED (IF APPLICABLE)? YES NO N/A
BUDGET AMENDMENT OR N/A

DETAILED BUDGET AMENDMENT ATTACHED YES NO N/A

6. BACKGROUND: (WHY IS THE ACTION NECESSARY, WHAT GOAL WILL BE ACHIEVED)
During the design of the Segment 2 project it appeared from the title reports that the City owned 20' wide right-of-way along the western boundary of the northern parking lot of the Holiday Inn. Therefore, the project was designed to utilize this area and install a large portion of Gulf Power equipment which would result in the loss of approximately 10 parking spaces for the hotel. During construction, City staff met with the property owners and it was found that the r/w in question was actually dedicated to the prior property owner in the early 70s which was prior to the City requiring a referendum to abandon r/w and therefore was never recorded through Bay County. Staff and Gulf Power met with the owners to come up with a design solution that would have less impact on the owners, but would still allow required gulf power infrastructure to be installed in that approximate location. The changes now almost run the entire length of the western property line which resulted in a change order to compensate for an additional 450 LF and gulf power equipment (see attached). This includes the under-grounding of power and removing and replacing existing infrastructure. Staff has reviewed the change order and recommends approval of \$181,200.94.

In addition, staff has currently been utilizing the tax savings to cover minor change orders for this project which has allowed the original contract cost to only be increased by \$2,123.17 to this point. However, we are requesting Council authorization for an additional \$220,000.00 in contingencies to account for future unforeseen conflicts that may arise during the remainder of this project (\$100,000 from CRA budget, \$50,000 from water and \$70,000 from sewer). This amount is 1.55% of the original contract amount. It is important to note that this section of Front Beach Road is one of the oldest commercial areas on the beach and has very limited documentation for existing buried infrastructure.

Staff recommends approval of both Change Order #11 and the contingencies for a total amount of \$401,200.94. A budget amendment is attached for your use. All departments have adequate funding for this amendment.

RESOLUTION 18-34

A RESOLUTION OF THE CITY OF PANAMA CITY BEACH, FLORIDA APPROVING A CHANGE ORDER TO THE CITY'S AGREEMENT WITH GAC CONTRACTORS FOR THE FRONT BEACH ROAD REDEVELOPMENT PROJECT IN THE TOTAL AMOUNT \$401,200.94 FOR GENERAL CONTINGENCIES AND SPECIFIC COSTS ARISING FROM THE REDESIGN OF GULF POWER IMPROVEMENTS AT THE HOLIDAY INN; AUTHORIZING A BUDGET AMENDMENT FOR THESE PURPOSES; AND PROVIDING AN IMMEDIATELY EFFECTIVE DATE.

BE IT RESOLVED by the City of Panama City Beach, Florida that:

1. The appropriate officers of the City are authorized but not required to approve that certain Change Order #11 to the City's Agreement with GAC Contractors, Inc. related to the Front Beach Road Segment 2 Redevelopment Project, to provide generally for contingencies and specifically for costs arising from a redesign of Gulf Power improvements at the Holiday Inn, in the total amount of Four Hundred One Thousand Two Hundred Dollars and Ninety Four Cents (\$401,200.94), as set forth in the Change Order attached hereto as Exhibit A and presented to the Council today.
2. The following budget amendment (# 5) is adopted for the City of Panama City Beach, Florida, for the fiscal year beginning October 1, 2017, and ending September 30, 2018, as shown in and in accordance with the attached and incorporated Exhibit B, for the purposes stated herein.
3. This Resolution shall take effect immediately upon passage.

PASSED, APPROVED AND ADOPTED at the regular meeting of the City Council of the City of Panama City Beach, Florida, this 14th day of December, 2017.

CITY OF PANAMA CITY BEACH

By: _____
Mike Thomas, Mayor

ATTEST:

Jo Smith, City Clerk

AGENDA ITEM # 9

Front Beach Road Segment2 – Change Order #11 (Holiday Inn Power Revised Improvement Costs)

Description	Quantity	Units	Material Unit	Material Subtotal	7.5% Tax	Material Total	Labor/ Equipment Unit	Labor/ Equipment Total	Subcontract Unit	Subcontract Total	TOTAL
Pull Boxes	3	EA	\$3,899.00	\$11,697.00	\$877.28	\$12,574.28	\$2,950.00	\$8,850.00			\$21,424.28
Riser	3	EA	\$28.66	\$85.98	\$6.45	\$92.43	\$25.00	\$75.00			\$167.43
3 - 2" Conduit	645	LF	\$1.60	\$1,032.00	\$77.40	\$1,109.40	\$15.00	\$9,675.00			\$10,784.40
4 - 4" Conduit (w/ Concrete)	110	LF	\$27.22	\$2,994.20	\$224.57	\$3,218.77	\$49.17	\$5,408.70			\$8,627.47
8 - 4 Conduit (w/ Concrete)	290	LF	\$54.45	\$15,790.50	\$1,184.29	\$16,974.79	\$49.17	\$14,259.30			\$31,234.09
12 - 4" Conduit (w/ Concrete)	15	LF	\$81.68	\$1,225.20	\$91.89	\$1,317.09	\$73.76	\$1,106.40			\$2,423.49
16 - 4" Conduit (w/ Concrete)	270	LF	\$108.90	\$29,403.00	\$2,205.23	\$31,608.23	\$73.76	\$19,915.20			\$51,523.43
Fence	30	LF							\$25.00	\$750.00	\$750.00
Curb and Gutter	45	LF							\$20.00	\$900.00	\$900.00
Demo Parking Lot	442	SY							\$3.00	\$1,326.00	\$1,326.00
Replace Paving	442	SY							\$35.00	\$15,470.00	\$15,470.00
Restripe Spaces	800	LF							\$2.75	\$2,200.00	\$2,200.00
Bumper Blocks Remove and Replace	40	EA							\$83.75	\$3,350.00	\$3,350.00
Landscape	1	LS							\$2,500.00	\$2,500.00	\$2,500.00
Sod	140	SY							\$2.75	\$385.00	\$385.00
Sub Total				\$62,227.88	\$4,667.09	\$66,894.97		\$59,289.60		\$26,881.00	\$153,065.57

Sub Total	\$153,065.57
Profit / Overhead (17.5%)	\$26,786.47
Sub Total + P/O	\$179,852.05
Bond (0.75%)	\$1,348.89
Total	\$181,200.94

Exhibit A

AGENDA ITEM # 9

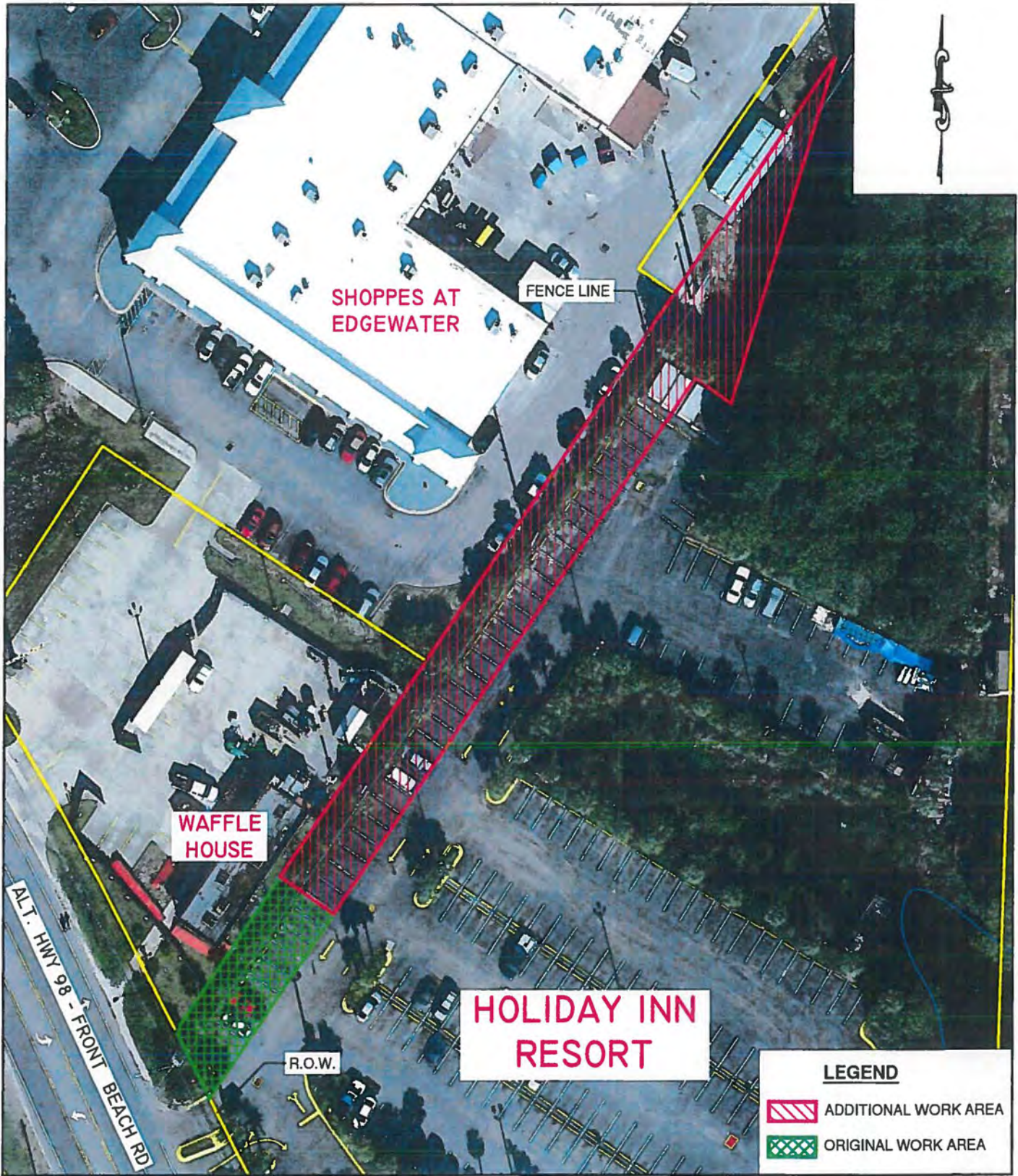

CITY OF P.C.B.	
PUBLIC WORKS DEPARTMENT	
REV.BY	DATE
L.J.S.	12/5/17

EXHIBIT I
PANAMA CITY BEACH
 CRA SEGMENT 2 - HOLIDAY INN CHANGE ORDER #II
 SHEET 1 OF 1

AGENDA ITEM # 9

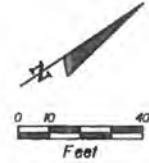
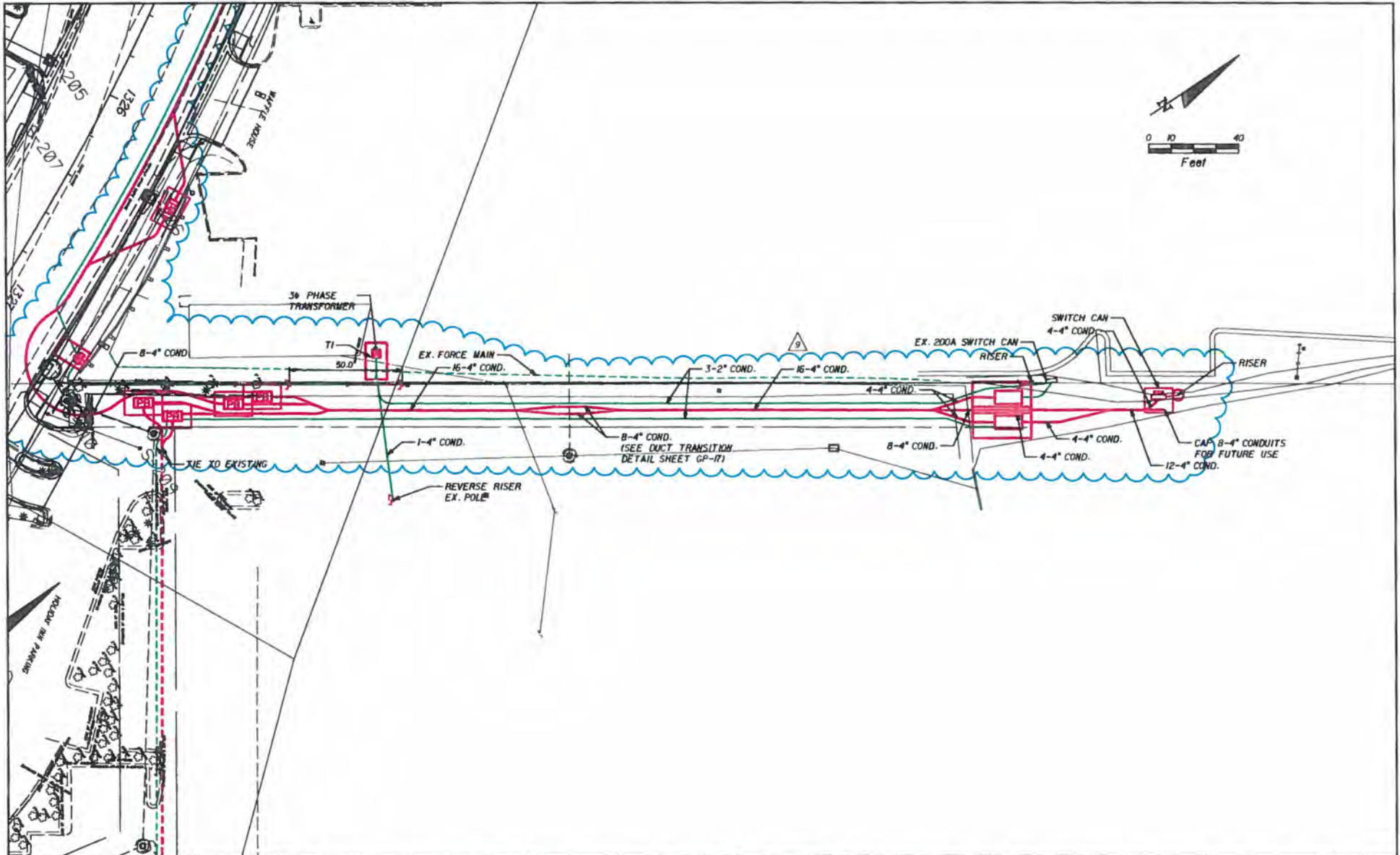

AGENDA ITEM #

9

DATE		BY	DESCRIPTION	REVISIONS		DATE	BY	DESCRIPTION
10/30/17			ADJUSTED LAYOUT, ADDED SHEET	9				

Engineer of Record:
ATKINS
 Certificate of Authority No. 24
 www.atkins.com/usa/panama-beach

Gregory S. Allen
 P.E. # 54050
 200 Airport Blvd
 Suite 1400
 Panama, FL 32304
 850.479.9244
 www.atkins.com



CITY OF PANAMA CITY BEACH
 CONSTRUCTION PLANS FOR:
 FRONT BEACH ROAD
 SEGMENT 2

GULF POWER COMPANY PLANS
HOLIDAY INN PARKING LOT

SHEET NO.
 GP-15A

**CITY OF PANAMA CITY BEACH
BUDGET TRANSFER FORM BF-10**

No. BA # 5

FUND	UTILITY ACCOUNT NUMBER	ACCOUNT DESCRIPTION	APPROVED BUDGET	BUDGET ADJUSTMENT	NEW BUDGET BALANCE
TO	401-3300-533.65-62	Construction-in-Progress CRA Water/Sewer Relocations	600,000.00	50,000.00	650,000.00
TO	401-3500-535.65-62	Construction-in-Progress CRA Water/Sewer Relocations	200,000.00	70,000.00	270,000.00
FROM	401-8100-999.96-00	Reserves Available for Expenditures	37,634,369.00	(120,000.00)	37,514,369.00
	CRA				
TO	160-5901-559.65-82	Construction-in-Progress FBR Segment 2	9,800,000.00	281,201.00	10,081,201.00
FROM	160-5901-559.95-00	Reserves Restricted	10,772,373.00	(281,201.00)	10,491,172.00
		Check Adjustment Totals:	59,006,742.00	0.00	59,006,742.00

BRIEF JUSTIFICATION FOR BUDGET ADJUSTMENT:

To reflect budget amendment for CRA Front Beach Road Segment 2 project for redesign of Gulf Power infrastructure location and to increase contingency for the balance of the project for potential unforeseen conflicts

ROUTING FOR APPROVAL

_____ DEPARTMENT HEAD _____ DATE

_____ CITY MANAGER _____ DATE

_____ FINANCE DIRECTOR _____ DATE

EXH. BIT B

GENDA ITEM #

9

REGULAR AGENDA
ITEM 10



CITY OF PANAMA CITY BEACH AGENDA ITEM SUMMARY

1. DEPARTMENT MAKING REQUEST/NAME:

Public Works/Paul Casto

2. MEETING DATE:

12/14/2017

3. REQUESTED MOTION/ACTION:

Provide a letter of support for the proposed Safe Route To Schools (SRTS) grant application package.

4. AGENDA

PRESENTATION
PUBLIC HEARING
CONSENT
REGULAR

5. IS THIS ITEM BUDGETED (IF APPLICABLE)? YES NO

N/A

DETAILED BUDGET AMENDMENT ATTACHED YES NO

N/A

6. BACKGROUND: (WHY IS THE ACTION NECESSARY, WHAT GOAL WILL BE ACHIEVED)

City staff applied for the SRTS grant last year December 2016 for the same 4 locations. There was a large pool of submitted projects to pull from and we were not awarded the grant. Staff is reapplying again this year for design and construction for connecting existing sidewalk and providing proposed sidewalk in the areas around Arnold High School, Surfside Middle School, and Hutchinson Beach Elementary to give local children a safe route to schools when they are within walking distance. Breakfast Point Schools are currently surrounded by sidewalks and provide both an adequate safe path to and from school. Since Hill Road is located within a 2 mile radius and contains Summerwood Subdivision staff suggested this roadway be include to help with a safe route to school for children in that area. The next cycle deadline is at the end of December and one of the requirements is a letter of support from the City Council.

RESOLUTION 18-28

A RESOLUTION OF THE CITY OF PANAMA CITY BEACH, FLORIDA, INDICATING ITS SUPPORT OF THE CITY'S PURSUIT OF A "SAFE ROUTES TO SCHOOL" GRANT; AUTHORIZING THE CITY MANAGER TO PROVIDE A LETTER OF SUPPORT AND ANY OTHER DOCUMENTS NECESSARY TO SATISFY THE REQUIREMENTS OF THE APPLICATION FOR THE GRANT; AND PROVIDING AN IMMEDIATELY EFFECTIVE DATE.

WHEREAS, the City wishes to apply for the Florida Department of Transportation's Safe Routes to School Grant Program ("Program"), for funding to construct sidewalks on Clara Avenue, Nautilus Road, Alf Coleman Road and Hills Road.

WHEREAS, the grant project requires no matching funds from the City, but the application does require a statement of support from the City.

NOW, THEREFORE, BE IT RESOLVED BY THE CITY OF PANAMA CITY BEACH, AS FOLLOWS:

Section 1. Approval of Safe Routes to School Grant Application. The City Council hereby supports the City's pursuit of the Florida Department of Transportation's Safe routes to School Grant Program for funding to construct sidewalks on Clara Avenue, Nautilus Road, Alf Coleman Road and Hills Road.

Section 2. Authorization of the City Manager. The City Manager is authorized to provide a letter of support and any other documents necessary to satisfy the requirements of the application for the Program.

This Resolution shall become effective immediately upon its adoption.

PASSED AND ADOPTED, in regular session this ____ day of _____, 2017.

CITY OF PANAMA CITY BEACH

By: _____
Mike Thomas, Mayor

ATTEST:

Jo Smith, City Clerk

Resolution 18-28

AGENDA ITEM # 10



**CITY OF
PANAMA CITY BEACH**

**HILL RD
SIDEWALK PROJECT**



NO. OF SHEETS
1 3

SITE
HILL R

INDEX OF PLANS

TITLE	NO.
COVER SHEET AND VICINITY MAP	1
HILL RD SIDEWALK PROJECT (EXISTING CONDITIONS)	2
HILL RD SIDEWALK PROJECT (PROPOSED CONDITIONS)	3

VICINITY MAP



— = PROJECT LOCATIONS

CITY OFFICIALS

MIKE THOMAS
JOHN RICHARD
PHIL CHESTER
JOSIE STRANGE
DIRECTOR SOLIS

MARIO GIBBERT
DIANE FOWLER

MAYOR
COUNCILMAN - WARD 1
COUNCILMAN - WARD 2
COUNCILWOMAN - WARD 3
COUNCILMAN - WARD 4

CITY MANAGER
CITY CLERK

CITY OF PANAMA CITY BEACH	
HILL RD SIDEWALK PROJECT	
Drawn By: LAR	Project No.: —
Designed By: LAR	Page No.: 1
Date: 8/15/18	Field Book: 54
Checked By: LAR	

Picture 1: Intersection of Back Beach Road and Hill Road. East side of Hill Road Right of Way looking north.

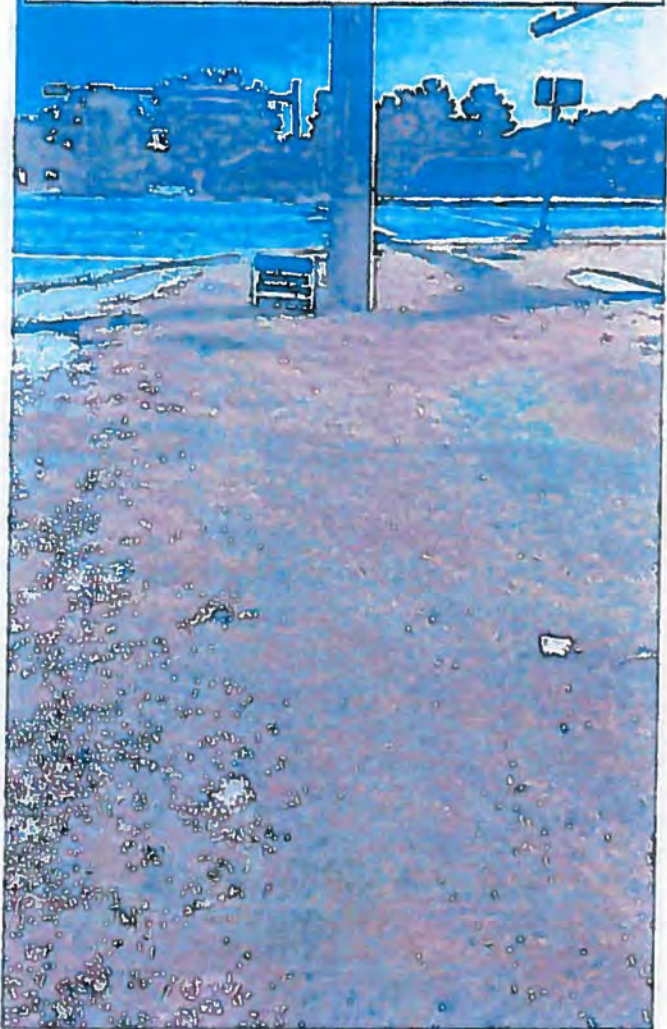

Picture 2: East side of Hill Road Right of Way looking south. Along the Summerwood Subdivision.



Picture 3: East side of Hill Road Right of Way looking south. Along the Summerwood Subdivision entrance.

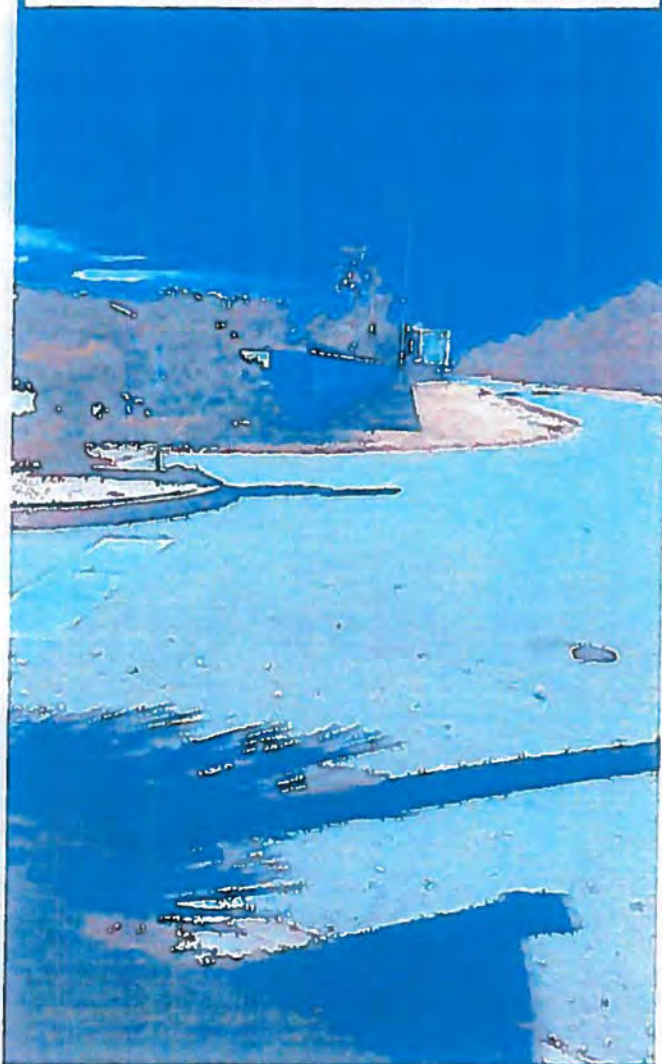

Picture 4: East side of Hill Road Right of Way looking south.



Picture 5: East side of Hill Road Right of Way looking south. Close to the intersection of Front Beach Road.





CITY OF PANAMA CITY BEACH

J.R. ARNOLD HIGH SCHOOL ALF COLEMAN RD SIDEWALK PROJECT



DATE: 8/19/2016
PAGE: 1
OF: 6

AGENDA ITEM # 10

INDEX OF PLANS

TITLE	NO
COVER SHEET AND VICINITY MAP	1
J.R. ARNOLD HIGH SCHOOL	
ALF COLEMAN RD SIDEWALK PROJECT (EXISTING CONDITIONS)	2
1 OF 2	
J.R. ARNOLD HIGH SCHOOL	
ALF COLEMAN RD SIDEWALK PROJECT (EXISTING CONDITIONS)	3
2 OF 2	
J.R. ARNOLD HIGH SCHOOL	
ALF COLEMAN RD SIDEWALK PROJECT (PROPOSED CONDITIONS)	4
1 OF 2	
J.R. ARNOLD HIGH SCHOOL	
ALF COLEMAN RD SIDEWALK PROJECT (PROPOSED CONDITIONS)	5
2 OF 2	
BAY DISTRICT SCHOOLS 2015-2018 HIGH SCHOOL ATTENDANCE ZONES	6

VICINITY MAP



SITE
J.R. ARNOLD
HIGH SCHOOL

— = PROJECT LOCATIONS

CITY OFFICIALS

- | | |
|----------------|-----------------------|
| MIKE THOMAS | MAYOR |
| JOHN REICHIARD | COUNCILMAN - WARD 1 |
| PHIL CHESTER | COUNCILMAN - WARD 2 |
| JOSIE STRANGE | COUNCILWOMAN - WARD 3 |
| HECTOR SOLIS | COUNCILMAN - WARD 4 |
| MARIO GIBBERT | CITY MANAGER |
| DIANE FOWLER | CITY CLERK |

CITY OF PANAMA CITY BEACH	
J.R. ARNOLD HIGH SCHOOL ALF COLEMAN RD SIDEWALK PROJECT	
Drawn By: LJS	Project No.: —
Designed By: MLY	Page No.: 1
Date: 8/19/16	Field Book: N/A
Checked By: MLY	

F:\CAD\PROJECTS-LANCE\2016\GIS\Drawings\Projects\DWG\Sidewalk Projects\8-11.dwg 8/18/2016 11:40:45 AM, Adobe PDF

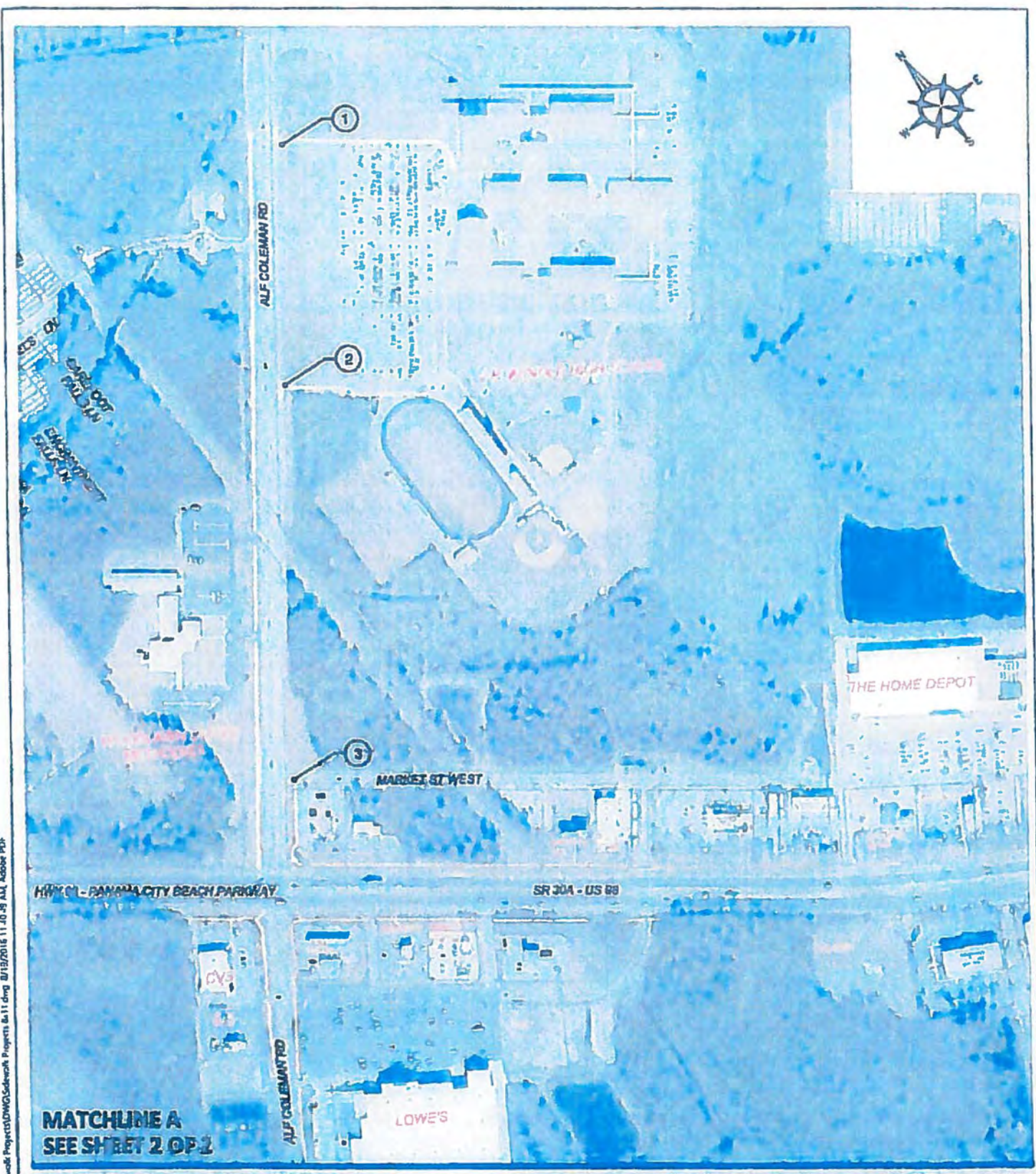

LEGEND

-  EXISTING SIDEWALK
-  PICTURE LOCATIONS

**J.R. ARNOLD HIGH SCHOOL
ALF COLEMAN RD SIDEWALK PROJECT
(EXISTING CONDITIONS)**

1 OF 2

DATE	DRAWN BY	CHECKED BY
8-18-16	LJS	KLY

AGENDA ITEM # 10

I:\CAD\PROJECTS-LANES\2016\Sidewalks\Projects\8.11.dwg 8/13/2016 11:50:26 AM, Adobe PDF



**MATCHLINE A
SEE SHEET 2 OF 2**

**J.R. ARNOLD HIGH SCHOOL
(TOTAL L.F. ON PAGE 2 OF 2)**

LEGEND

 **PROPOSED SIDEWALK**

DATE	DRAWN BY	CHECKED BY
8-18-16	L.J.S.	K.L.Y.

**J.R. ARNOLD HIGH SCHOOL
ALF COLEMAN RD SIDEWALK PROJECT
(PROPOSED CONDITIONS)**

1 OF 2

AGENDA ITEM # 10

MATCHLINE A
SEE SHEET 1 OF 2



J.R. ARNOLD HIGH SCHOOL
3286± L.F. (TOTAL)

J.R. ARNOLD HIGH SCHOOL
ALF COLEMAN RD SIDEWALK PROJECT
(PROPOSED CONDITIONS)

2 OF 2

LEGEND

 **PROPOSED SIDEWALK**





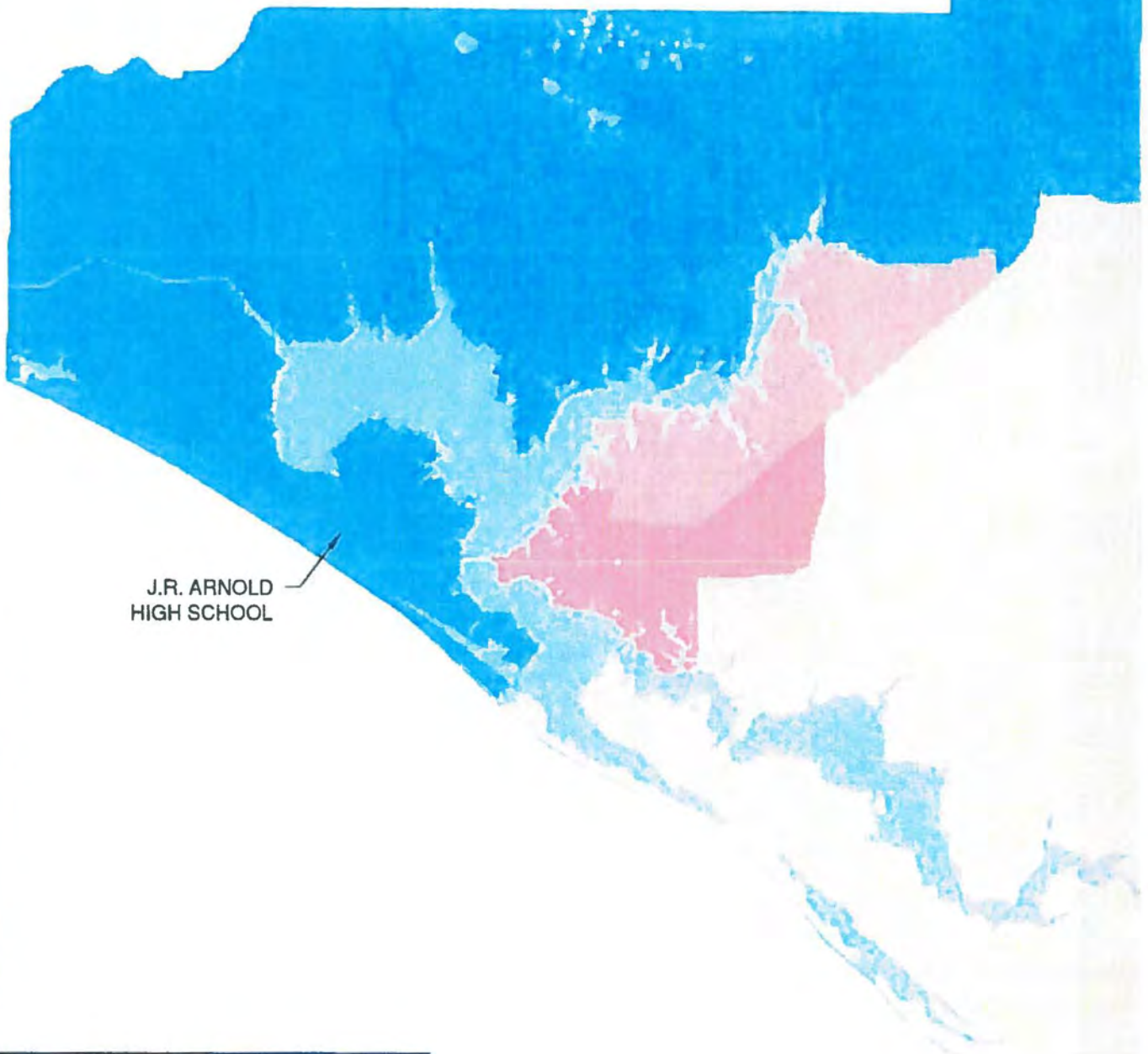

DATE	DRAWN BY	CHECKED BY
8-18-16	L.J.S	K.L.Y.

P:\CAD\PROJECTS-LAN\CT2014\Sidewalk Projects\DWG\Sidewalk Projects 8.11.dwg 8/19/2016 11:52:11 AM, Adobe PDF

Bay District Schools 2017 - 2018 High School Attendance Zones



J.R. ARNOLD
HIGH SCHOOL

	A Crawford Mosley High School		JR Arnold High School
	Bay High School		Rutherford High School
	Deane Bozeman High School		Gulf County Schools

Picture 1: East side of Alf Coleman Road looking south. At north driveway at Arnold High School.



Picture 2: East side of Alf Coleman Road looking south. At south driveway at Arnold High School.



Picture 3: East side of Alf Coleman Road looking south. Near intersection of Alf Coleman and Back Beach Road.

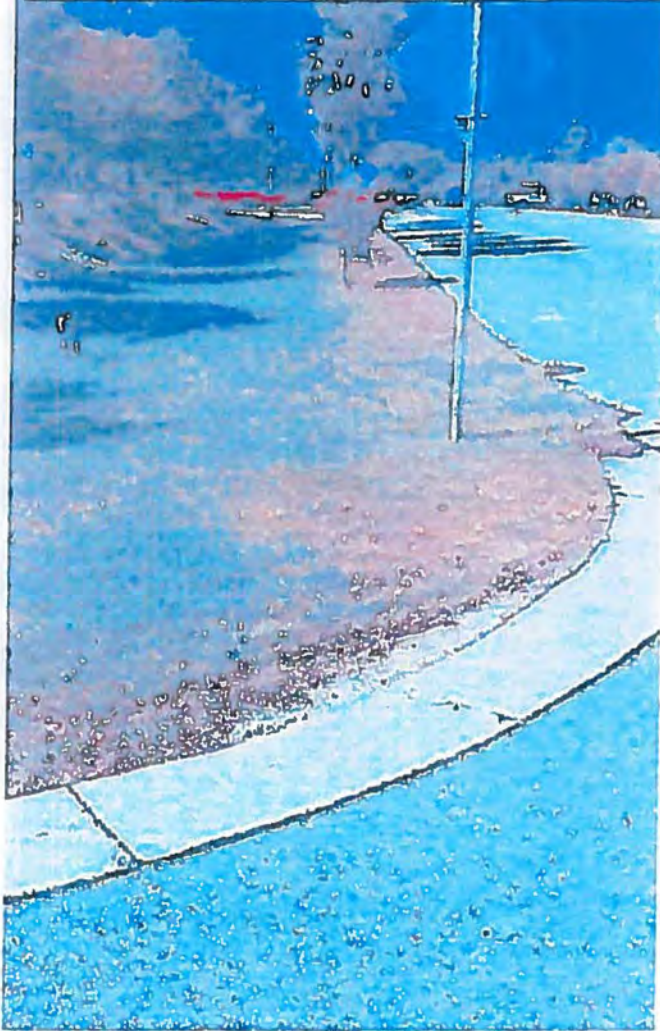

Picture 4: East side of Alf Coleman Road looking south. Guardrail in front of Lowe's where storm pipes are to be extended and new headwall constructed.

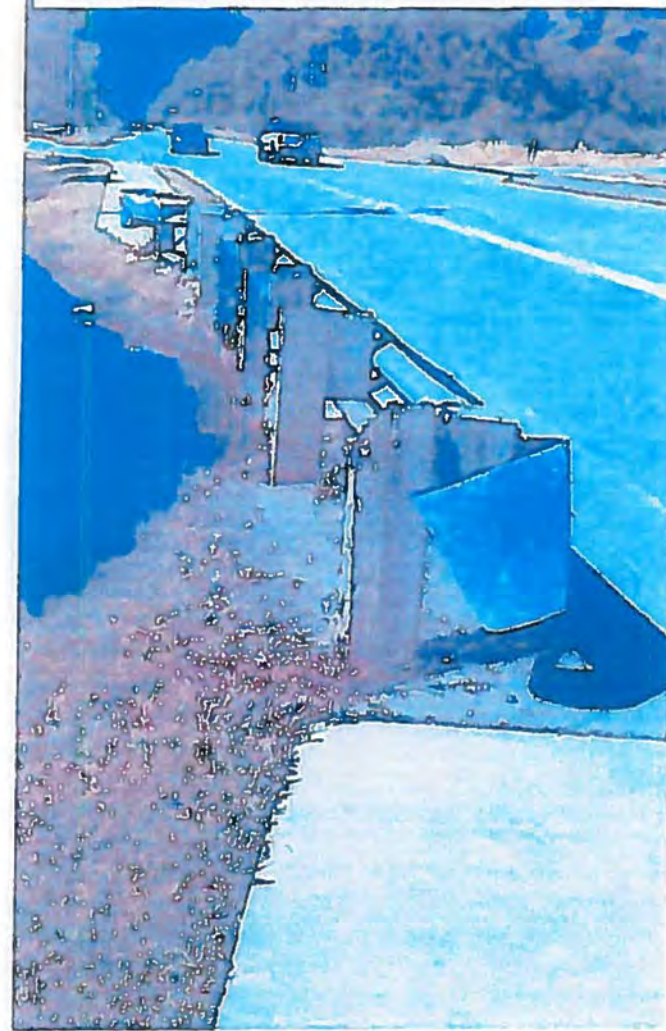

Picture 5: East side of Alf Coleman Road looking south. Guardrail near Harrison Walk Subdivision where storm pipes are to be extended and new headwall constructed.



Picture 6: East side of Alf Coleman Road looking north. Near intersection of Alf Coleman and Middle Beach Road.



Picture 7: East side of Alf Coleman Road looking south. Across from Miracle Strip Water Park.



Picture 8: East side of Alf Coleman Road looking south. Across from Miracle Strip Water Park.

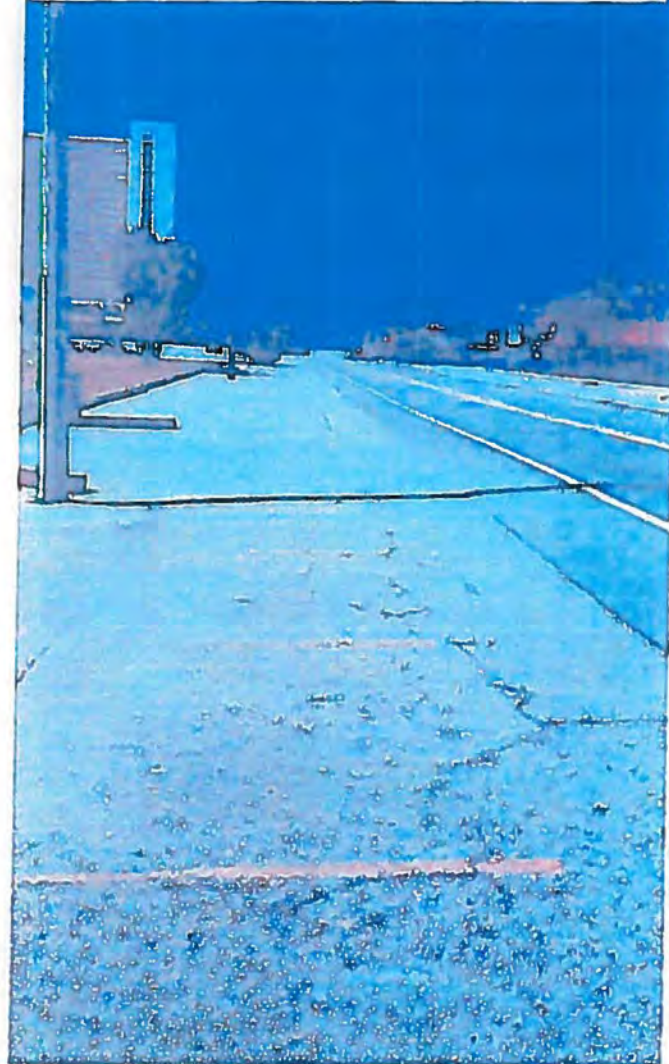



**CITY OF
PANAMA CITY BEACH**

**HUTCHISON BEACH
ELEMENTARY SCHOOL
CLARA AVE SIDEWALK PROJECT**

LOCATION MAP



NO. OF
1
SHEETS
4

INDEX OF PLANS

TITLE	NO.
COVER SHEET AND VICINITY MAP	1
HUTCHISON BEACH ELEMENTARY SCHOOL	2
CLARA AVE SIDEWALK PROJECT (EXISTING CONDITIONS)	3
HUTCHISON BEACH ELEMENTARY SCHOOL	4
CLARA AVE SIDEWALK PROJECT (PROPOSED CONDITIONS)	
BAY DISTRICT SCHOOLS 2015-2016 ELEMENTARY SCHOOL ATTENDANCE ZONES	

VICINITY MAP



SITE
HUTCHISON BEACH
ELEMENTARY SCHOOL

— = PROJECT LOCATIONS

CITY OFFICIALS

MIKE THOMAS	MAYOR
JOHN REICHIARD	COUNCILMAN - WARD 1
PHIL CHESTER	COUNCILMAN - WARD 2
JOSIE STRANGE	COUNCILWOMAN - WARD 3
HECTOR SOLIS	COUNCILMAN - WARD 4
MARIO GISBERT	CITY MANAGER
DIANE FOWLER	CITY CLERK

CITY OF PANAMA CITY BEACH	
HUTCHISON BEACH ELEMENTARY SCHOOL	
CLARA AVE SIDEWALK PROJECT	
Drawn By: L.S.S.	Project No.: —
Designed By: S.A.Y.	Page No.: 1
Date: 8/18/18	Field Book: 828
Checked By: S.A.Y.	



HUTCHISON BEACH ELEMENTARY
3508± L.F. (TOTAL)

HUTCHISON BEACH ELEMENTARY
CLARA AVE SIDEWALK PROJECT
(PROPOSED CONDITIONS)

LEGEND
 — PROPOSED SIDEWALK

DATE	DRAWN BY	CHECKED BY
8-18-16	LJS	KLY

I:\CAD\PROJECTS\LANCET\1016\5\Drawings\Pro\1016\DWG\03\Hutchison Project.dwg 8/18/2016 11:53:40 AM, A00008 P.04

Bay District Schools 2017 - 2018 Elementary School Attendance Zones

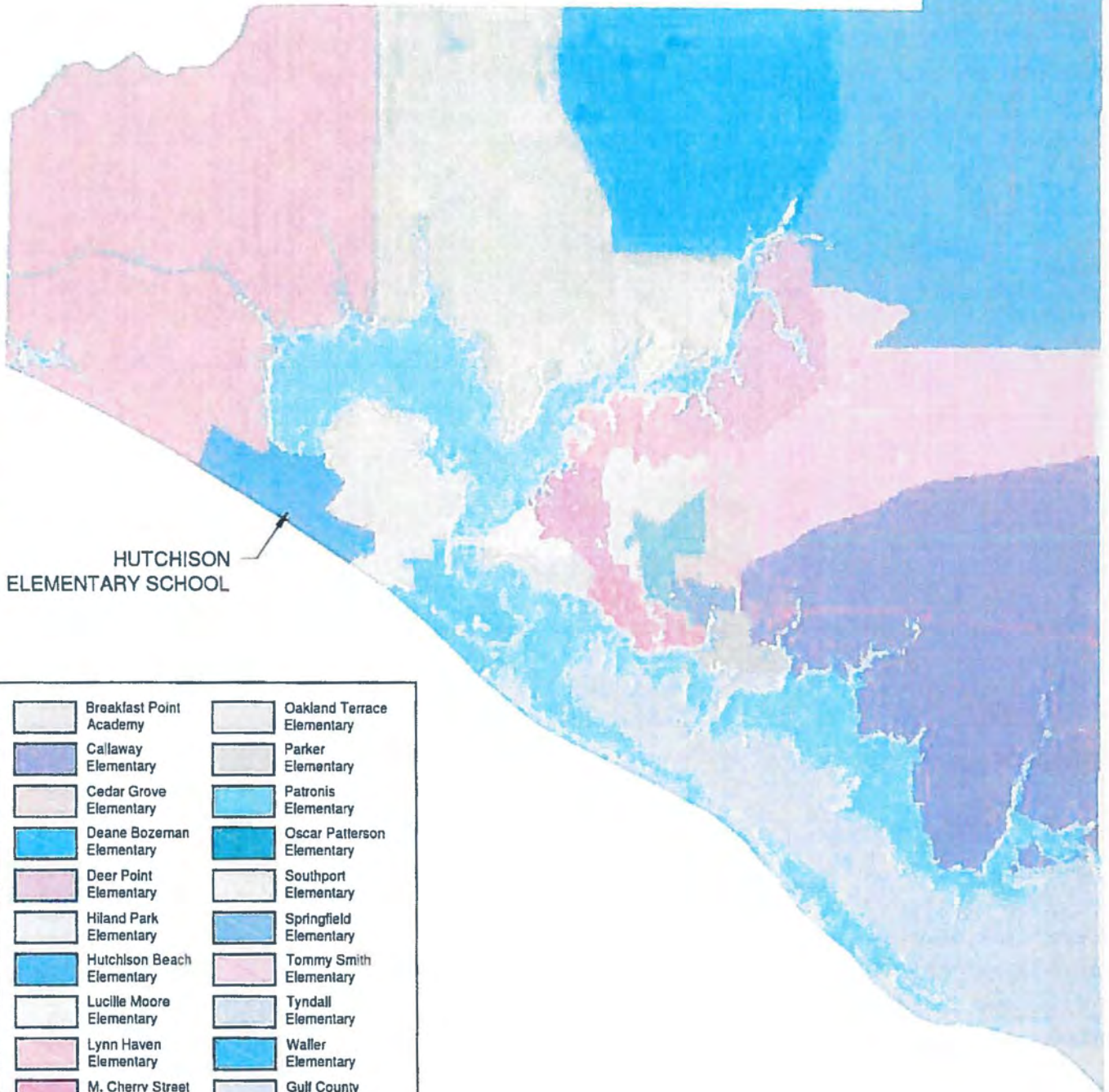

HUTCHISON
ELEMENTARY SCHOOL

	Breakfast Point Academy		Oakland Terrace Elementary
	Callaway Elementary		Parker Elementary
	Cedar Grove Elementary		Patronis Elementary
	Deane Bozeman Elementary		Oscar Patterson Elementary
	Deer Point Elementary		Southport Elementary
	Hiland Park Elementary		Springfield Elementary
	Hutchison Beach Elementary		Tommy Smith Elementary
	Lucille Moore Elementary		Tyndall Elementary
	Lynn Haven Elementary		Waller Elementary
	M. Cherry Street Elementary		Gulf County Schools
	Northside Elementary		West Bay Elementary

Picture 1: Intersection of Back Beach Road and Clara Avenue. West side of Clara Avenue Right of Way looking north.



Picture 2: West side of Clara Avenue looking south. Drainage headwall and piping to be extended at this location.



Picture 3: East side of Clara Avenue looking south. Near residential houses, Tapestry Park Subdivision, and Hutchinson Beach Elementary.

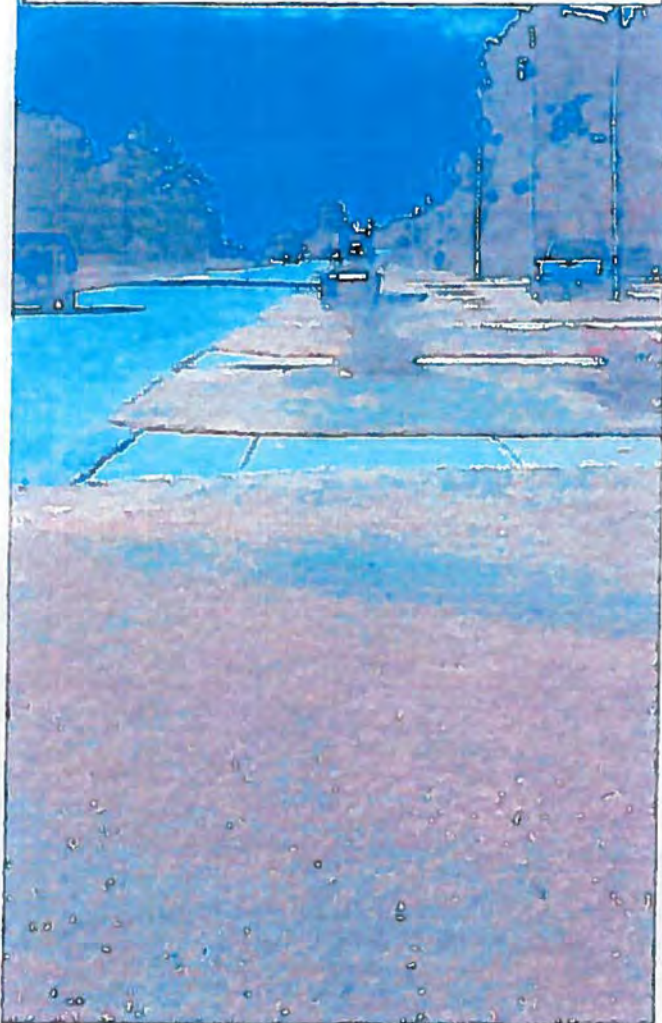

Picture 4: East side of Clara Avenue looking south. South side of Middle Beach Road.



Picture 5: East side of Clara Avenue looking south.

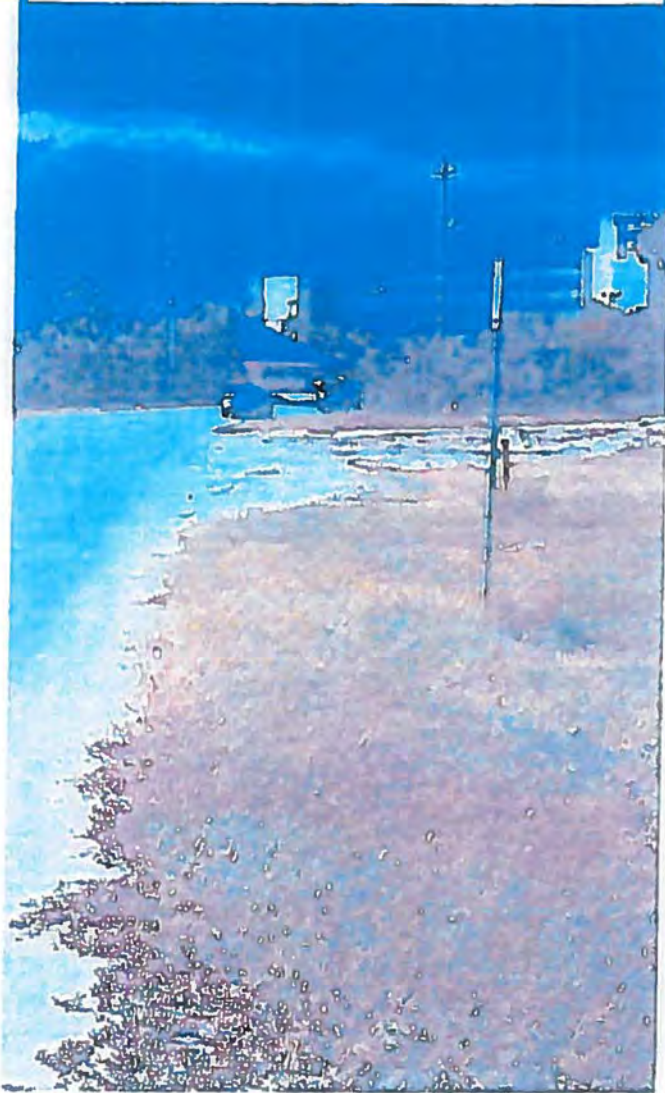

Picture 6: East side of Clara Avenue looking south. Intersection of Clara Avenue and Front Beach Road.



Picture 7: South Right of Way of Middle Beach Road looking west.

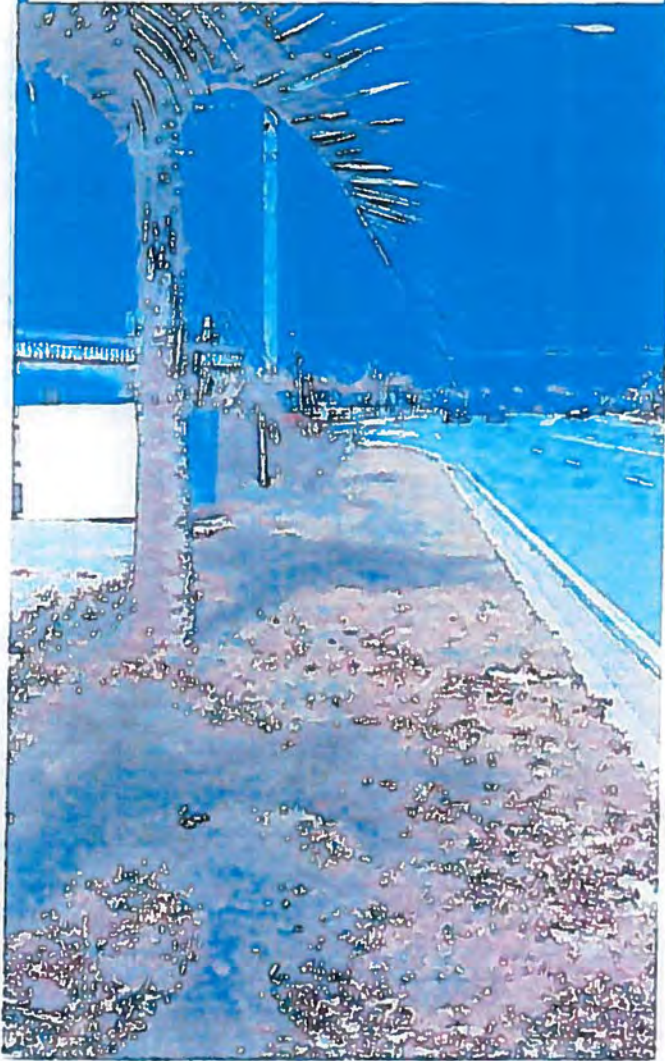

Picture 8: South Right of Way of Middle Beach Road looking east.

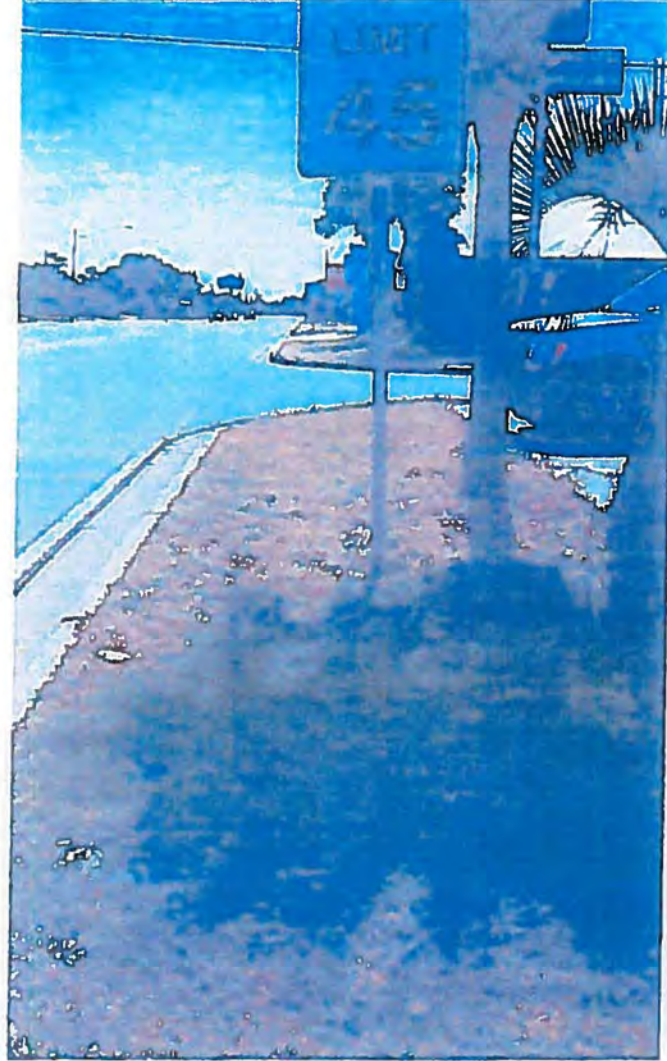

Picture 9: South Right of Way of Middle Beach Road looking east.



Picture 10: South Right of Way of Middle Beach Road looking east.



Picture 11: South Right of Way of Middle Beach Road looking east.





**CITY OF
PANAMA CITY BEACH**

**SURFSIDE MIDDLE SCHOOL
NAUTILUS RD
SIDEWALK PROJECT**



PROJECT NO. 1
SHEET NO. 4

AGENDA ITEM # 10

INDEX OF PLANS

TITLE	NO.
COVER SHEET AND VICINITY MAP	1
SURFSIDE MIDDLE SCHOOL NAUTILUS RD SIDEWALK PROJECT (EXISTING CONDITIONS)	2
SURFSIDE MIDDLE SCHOOL NAUTILUS RD SIDEWALK PROJECT (PROPOSED CONDITIONS)	3
BAY DISTRICT SCHOOLS 2015-2016 MIDDLE SCHOOL ATTENDANCE ZONES	4

VICINITY MAP



— = PROJECT LOCATIONS

CITY OFFICIALS

MIKE THOMAS	MAYOR
JOHN RICHARD	COUNCILMAN - WARD 1
PHIL CHESTER	COUNCILMAN - WARD 2
JOSIE STRANGE	COUNCILWOMAN - WARD 3
HECTOR SOLIS	COUNCILMAN - WARD 4
MARIO GISBERT	CITY MANAGER
DIANE FOWLER	CITY CLERK









CITY OF PANAMA CITY BEACH	
SURFSIDE MIDDLE SCHOOL NAUTILUS RD SIDEWALK PROJECT	
Drawn By: <u>LLB</u>	Project No.: <u> </u>
Designed By: <u>ELV</u>	Page No.: <u>1</u>
Date: <u>8/19/08</u>	Field Book: <u>8/8</u>
Checked By: <u>MAJ</u>	

Bay District Schools 2017 - 2018 Middle School Attendance Zones



SURFSIDE
MIDDLE SCHOOL



	Breakfast Point Middle School		Merritt Brown Middle School
	Deane Bozeman Middle School		Mowat Middle School
	Everitte Middle School		Surfside Middle School
	Jinks Middle School		Gulf County Schools

Picture 1: West side of Nautilus Road Right of Way in front of Surfside Middle School.



Picture 2: West side of Nautilus Road Right of Way.



Picture 3: West side of Nautilus Road Right of Way in front of Hidden Lagoon racetrack.



REGULAR AGENDA

ITEM 11



CITY OF PANAMA CITY BEACH AGENDA ITEM SUMMARY

1. DEPARTMENT MAKING REQUEST/NAME:

Public Works/Paul Casto

2. MEETING DATE:

12/14/2017

3. REQUESTED MOTION/ACTION:

Approve the proposed detour for Ocean Villa Condominium to paint one walkover.

4. AGENDA

PRESENTATION
PUBLIC HEARING
CONSENT
REGULAR

5. IS THIS ITEM BUDGETED (IF APPLICABLE)? YES NO N/A
BUDGET AMENDMENT OR N/A

DETAILED BUDGET AMENDMENT ATTACHED YES NO N/A

6. BACKGROUND: (WHY IS THE ACTION NECESSARY, WHAT GOAL WILL BE ACHIEVED)

Since the Ocean Villa Condominium was built they have permitted the existing walkover for routine cleaning and painting through the Florida Department of Transportation (FDOT). This segment of roadway was taken over by the City through the CRA and will now be part of our permitting process for maintenance.

Danny Wilson from Resort Collections who manages Ocean Villa Condominium has requested a detour be approved to allow crews to paint and repair the walkover during January. Should you approve this detour they would like to get everything in place with Acme Barricades as soon as possible and get material ordered. The dates they have requested to do this project are January 7th through January 14th. They will start each day at approximately 8:00 am and work until 5:00 pm. The detour would be in place during those hours and after 5pm the road would be reopened each day.

The detour will be conducted as shown on the Proposed ACME Barricades map. All MOT will be handled by the contractor, coordinated through Resort Collections, and follow all local and state requirements. This route has been used previously during this routine maintenance work and has been approved by FDOT in the past. Staff does not object with this project.

RESOLUTION NO. 18-35

A RESOLUTION OF THE CITY OF PANAMA CITY BEACH, FLORIDA, RELATED TO THE OCEAN VILLA CONDOMINIUM'S REPAIR AND MAINTENANCE OF ITS PEDESTRIAN BRIDGE OVER FRONT BEACH ROAD; AUTHORIZING TEMPORARY CLOSURE OF FRONT BEACH ROAD FROM THE INTERSECTIONS OF CHURCHWELL DRIVE TO HENLEY DRIVE DURING THE HOURS OF 8:00 A.M. AND 5:00 P.M. ON SUNDAY, JANUARY 7, 2018, THROUGH SUNDAY, JANUARY 14, 2018, FOR THE MAINTENANCE.

WHEREAS, the Ocean Villa Condominium desires to undertake certain repairs and maintenance of its pedestrian bridge beginning on Monday, January 7, 2018, and finishing on or before Sunday, January 14, 2018, and have requested that a portion of Front Beach Road be closed and traffic detoured while they undertake such maintenance.

NOW, THEREFORE, BE IT RESOLVED BY THE CITY COUNCIL of Panama City Beach that during the hours of 8:00 A.M. and 5:00 P.M. on January 7, 2018 through January 14, 2018, a portion of Front Beach Road from the intersections of Churchwell Drive to Henley Drive adjacent to the Ocean Villa Condominium shall be closed and all vehicular traffic on that portion of Front Beach shall be rerouted in accordance with the attached map which accompanies this Resolution.

PASSED, APPROVED AND ADOPTED IN REGULAR SESSION THIS ____ day of _____, 2017.

CITY OF PANAMA CITY BEACH

By: _____
Mike Thomas, Mayor

ATTEST:

Jo Smith, City Clerk

AGENDA ITEM # _____

//

Resolution 18-35

THIS MAINTENANCE OF TRAFFIC (MOT PLAN) IS THE EXCLUSIVE PROPERTY OF ACME BARRICADES, LC, AND IS PROVIDED SOLELY FOR INFORMATIONAL AND PLANNING PURPOSES. THE MOT PLAN HAS BEEN DESIGNED FOR THE EXCLUSIVE AUTHORIZED INTERPRETATION AND IMPLEMENTATION BY ACME BARRICADES, LC. THE MOT PLAN HAS NOT BEEN DESIGNED FOR DISTRIBUTION TO OR INTERPRETATION, IMPLEMENTATION AND RELIANCE BY ANY OTHER PARTY. ACME BARRICADES, LC DOES NOT MAKE ANY WARRANTIES OR REPRESENTATIONS RELATED TO THIS MOT PLAN. CUSTOMERS SHALL SUBMIT THIS PLAN TO THE APPROPRIATE GOVERNING AUTHORITY FOR APPROVAL PRIOR TO IMPLEMENTATION BY ACME BARRICADES, LC ONLY, PURSUANT TO AGREED UPON IMPLEMENTATION TERMS

www.inversion.com

Ark Hill Circle

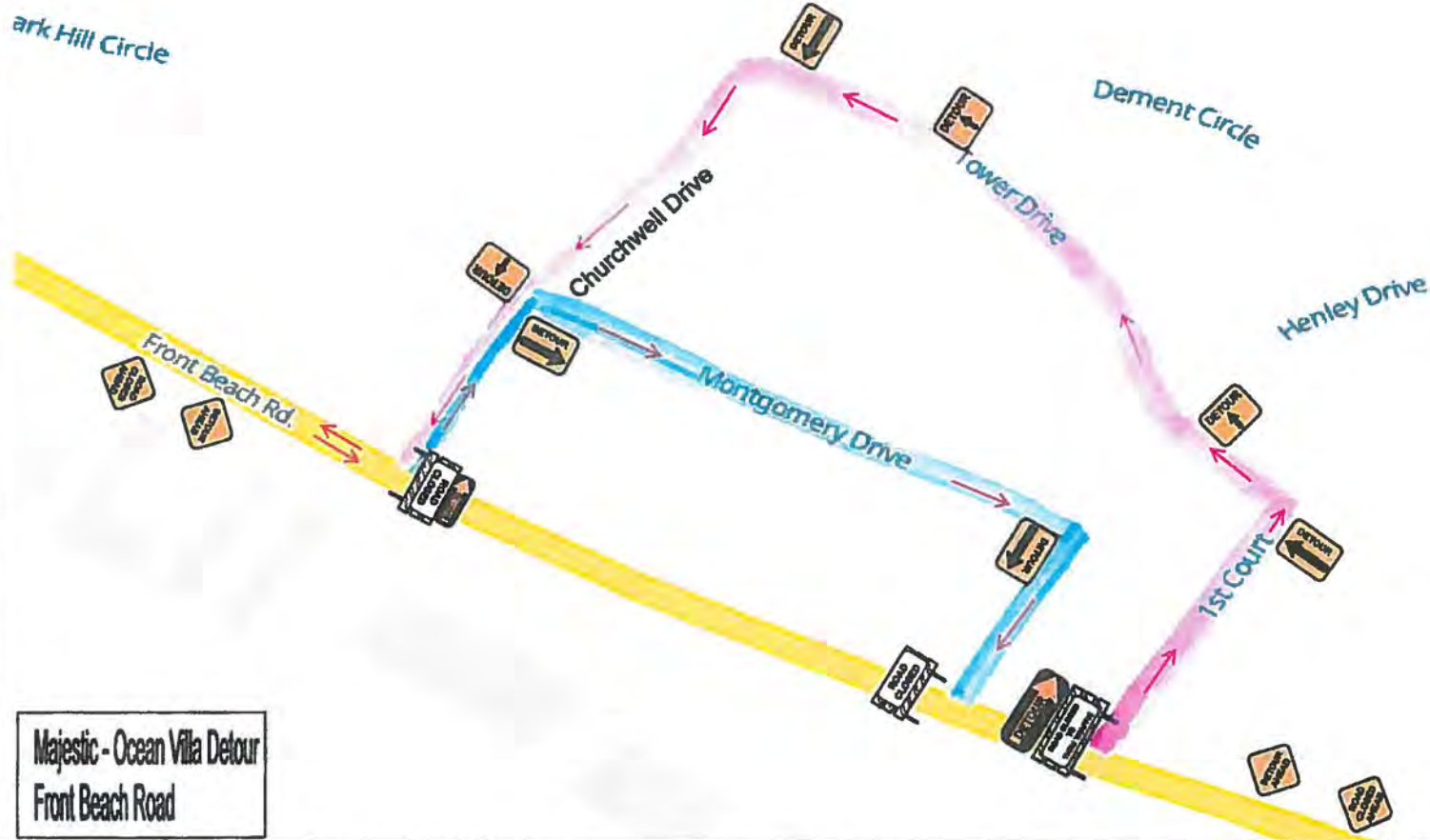

Majestic - Ocean Villa Detour
Front Beach Road



AGENDA ITEM # _____

//

REGULAR AGENDA

ITEM 12



CITY OF PANAMA CITY BEACH AGENDA ITEM SUMMARY

1. DEPARTMENT MAKING REQUEST/NAME:
LEGAL

2. MEETING DATE:
DECEMBER 14, 2017

3. REQUESTED MOTION/ACTION:
CONSIDER FIRST READING OF ORDINANCE AMENDING CHARTER TO CLARIFY THAT COMPETITIVE BIDDING IS REQUIRED FOR EXPENDITURES EXCEEDING \$10,000 PER ANNUM

4. AGENDA
PRESENTATION
PUBLIC HEARING
CONSENT
REGULAR

5. IS THIS ITEM BUDGETED (IF APPLICABLE)? YES NO N/A
BUDGET AMENDMENT OR N/A

DETAILED BUDGET AMENDMENT ATTACHED YES NO N/A

6. BACKGROUND: (WHY IS THE ACTION NECESSARY, WHAT GOAL WILL BE ACHIEVED)
THE CITY CHARTER PRESENTLY REQUIRES EXPENDITURES OVER \$10,000 BE COMPETITIVELY BID. STAFF REQUESTS COUNCIL'S CONSIDERATION OF A CHARTER AMENDMENT TO CLARIFY THAT THIS REQUIREMENT APPLIES TO EXPENDITURES EXCEEDING \$10,000 PER ANNUM, RATHER THAN TO ALL EXPENDITURES WHICH MAY EXCEED \$10,000 IN AGGREGATE. THE TYPES OF PROCUREMENTS MOST LIKELY TO BE AFFECTED ARE THOSE INVOLVING JOINT SERVICE AND GOODS CONTRACTS, SUCH AS THOSE FOR SOFTWARE LICENSES OR COPIER LEASES. THESE CONTRACTS OFTEN ARE MUCH LESS THAN \$10,000 PER YEAR BUT INVOLVE A TERM OF SEVERAL YEARS, SUCH THAT THE CHARTER'S THRESHOLD IS EXCEEDED OVER THE TERM OF THE CONTRACT.

IF COUNCIL APPROVES FIRST READING OF THIS ORDINANCE, THE ORDINANCE WILL BE PUBLISHED FOR SECOND READING AND PUBLIC HEARING ON JANUARY 11, 2018 . IF ADOPTED FOLLOWING SECOND READING, THE ORDINANCE WILL NOT BE EFFECTIVE UNTIL APPROVED BY REFERENDUM, AND A RESOLUTION TO PLACE THE QUESTION ON THE BALLOT WILL BE BROUGHT BACK TO THE COUNCIL FOR APPROVAL.

ORDINANCE NO. 1448

AN ORDINANCE OF THE CITY OF PANAMA CITY BEACH PROPOSING TO AMEND SECTION 5-7 OF THE CHARTER OF THE CITY RELATING TO COMPETITIVE BIDDING TO CLARIFY THAT THE EXPENDITURES OF TEN THOUSAND DOLLARS OR MORE *PER ANNUM* SHALL BE COMPETITIVELY BID; PROVIDING AN EFFECTIVE DATE; PROVIDING THAT THE AMENDMENT PROPOSED SHALL BE EFFECTIVE ONLY UPON THE APPROVAL OF REFERENDUM AS SPECIFIED IN THE ORDINANCE AND REPEALING ORDINANCES IN CONFLICT.

BE IT ENACTED BY THE PEOPLE OF THE CITY OF PANAMA CITY BEACH, FLORIDA:

SECTION 1. From and after the effective date hereof, Section 5-7 of the Charter of the City of Panama City Beach, relating to contracts, licenses, permits, et cetera, is hereby amended to read as follows (omitted text is ~~stricken~~ and new text is underlined):

Sec. 5-7. Competitive bidding.

(a) *Required.* No purchase by or on behalf of the City requiring the expenditure of ten thousand dollars (\$10,000.00) or more per annum shall be awarded, let or made except through competitive bidding after the advertisement for the bids in the form and manner prescribed in this Charter. No purchase or the quantity thereof shall be split for the purpose of avoiding the requirements of this section.

(b) *Publication of request for bids.* Published notice of each intended purchase by competitive bid shall be posted on a designated web-page noticed upon and linked to the landing page on the City's official web site for two consecutive weeks prior to the opening date of the bid, or published in a newspaper of general circulation within the City once each week for two consecutive weeks prior to the opening date of the bid. In addition to the posting requirements of this section, the City Council may direct the City

Manager to notify, by whatever means it chooses, additional potential suppliers of such requests for bids whenever the City Council determines that the website posting requirement of this section is inadequate to produce sufficiently competitive bidding. In emergency circumstances, notification time on the request may be shortened by the City Manager.

(c) *Contents of request for bids.* Each request for the submission of bids shall contain an acceptance clause granting the City a minimum of thirty (30) days in which to accept or reject the bid, during which time the tendered bid shall remain valid. The request for the submission of bids may contain a requirement that the bidder provide a performance bond in the full amount of the contract price and may further contain such other specifications and declarations as the City Council shall determine necessary for the proper evaluation of the bidder's proposal and qualifications.

(d) *Awards.* The City Council shall award the contract to the lowest fully responsive and responsible bidder; provided, that the City Council may award the contract to a bidder other than the lowest bidder should it find that the lowest bidder does not offer the reliability, quality of service or product afforded by such other bidder. Where a bid other than the lowest bid is taken, the City Council shall state the reasons upon which such award was made.

(e) *Rejection and resubmission for bids.* The City Council may reject all submitted bids and provide for the request of additional bids whenever it finds that the bids submitted are not responsive to the request for bids, that the bids are not responsible or that the bid prices are unacceptable. Requests for such additional bids shall comply with the provisions of this section.

(f) *Purchases on failure to receive bids.* Where no bids are received and the Council determines that additional requests for bids are unlikely to produce responses, the City Council may authorize the purchase, at the best obtainable price determined through direct quotation, of such products or services as are available on the open market.

(g) *Professional services.* Contracts for professional services, including but not limited to architects, attorneys, accountants, engineers and surveyors, may, upon approval by the City Council, be entered into without competitive bidding. The City Council shall review the qualifications, work history and other relevant data before contracts for such services are rendered. The Consultants' Competitive Negotiation Act shall be followed where applicable.

(h) *Emergency purchases.* The City Council may substitute competitive quotes for the competitive bidding required by this section upon a finding by extraordinary vote that a public emergency exists making the bid delay contrary to the public interest.

(i) *Piggybacking.* Notwithstanding the foregoing, a purchase of goods made by or on behalf of the City on the same terms and conditions as were obtained by the United States of America, the State of Florida, or a county, municipality or special district of the State of Florida, through an advertised, competitive bidding process in which bids were opened within one year prior to purchase by or on behalf of the City shall be deemed to be made through competitive bidding under this Charter.

(j) *Purchase of Goods for Utilities.* Notwithstanding the foregoing, a purchase by or on behalf of the City of goods which are to be used exclusively for the operation or maintenance of the City's potable water, stormwater, reuse-water or wastewater utility, or any combination of those utilities, and requiring the expenditure of not more than \$25,000 may be made by substituting competitive quotes for competitive bidding if required. No purchase or the quantity thereof shall be split for the purpose of avoiding the requirements of this section. This authorization shall not be utilized in conjunction with a construction or other service contract that requires competitive bidding

(k) *Sole Source.* Notwithstanding the foregoing, the City Council may authorize any purchase of goods without competitive bid when the City Council finds that the goods are to be used exclusively for the operation or maintenance of the City's potable water, stormwater, reuse-water or wastewater utility, or any combination of those utilities, that the goods are to replace a specialized, mechanical or electrical component of the utility, and that the goods are only available from a sole source of supply. The fact that the new component may increase capacity shall not disqualify this authorization. This authorization shall not be utilized in conjunction with a construction or other service contract that requires competitive bidding.

SECTION 2. If approved by referendum as provided in this Ordinance, the appropriate officers and agents of the City are authorized and directed to codify, include and publish the provisions of this Ordinance within the Panama City Beach Charter.

SECTION 3. All ordinances or parts of ordinances in conflict herewith are repealed to the extent of such conflict.

SECTION 4. This Ordinance shall take effect immediately upon passage,

but the amendment proposed hereby shall become effective immediately upon approval by a majority of the electors of the City voting in the next general election or special election called for such purpose; and if the electors shall not approve the amendment proposed by this Ordinance at such referendum, or should no referendum be held within one (1) year from the passage of this Ordinance, then the proposal not approved shall be void and of no force and effect.

PASSED, APPROVED AND ADOPTED at the regular meeting of the City Council of the City of Panama City Beach, Florida, this ___ day of _____, 2018.

MAYOR

ATTEST:

CITY CLERK

EXAMINED AND APPROVED by me this ___ day of ___, 2018.

MAYOR

Published in the _____ on the ___ day of _____, 2018.

Posted on pcbgov.com on the ___ day of _____, 2018.

REGULAR AGENDA

ITEM 13



CITY OF PANAMA CITY BEACH AGENDA ITEM SUMMARY

1. DEPARTMENT MAKING REQUEST/NAME:

ADMINISTRATION

2. MEETING DATE:

DECEMBER 14, 2017

3. REQUESTED MOTION/ACTION:

CONSIDER RESOLUTION REGARDING USE OF WOODEN LOUNGER BEACH CHAIRS AFTER OCTOBER 31, 2019

4. AGENDA

PRESENTATION
PUBLIC HEARING
CONSENT
REGULAR

5. IS THIS ITEM BUDGETED (IF APPLICABLE)? YES NO
BUDGET AMENDMENT OR N/A

N/A

DETAILED BUDGET AMENDMENT ATTACHED YES NO

N/A

6. BACKGROUND: (WHY IS THE ACTION NECESSARY, WHAT GOAL WILL BE ACHIEVED)

AT ITS OCTOBER 12 MEETING, THE COUNCIL EXPRESSED A DESIRE TO SEE THE WOODEN LOUNGERS REPLACED BY MORE PORTABLE BEACH CHAIRS, AND DIRECTED STAFF TO BRING FORWARD A RECOMMENDATION TO PROVIDE FOR THAT RESULT. ATTACHED IS A PROPOSAL THAT ESSENTIALLY PROHIBITS THE CITY MANAGER FROM PERMITTING THE OVERNIGHT STORAGE OF ITEMS ON THE BEACH AFTER OCTOBER 31, 2019. THE CITY'S LEAVE NO TRACE ORDINANCE PRESENTLY AUTHORIZES THE CITY MANAGER TO PERMIT THE OVERNIGHT STORAGE OF ITEMS RELATED TO BEACH SERVICES, AND NO AMENDMENT TO THAT ORDINANCE IS NECESSARY OR RECOMMENDED AT THIS TIME. SIMILARLY, BECAUSE THE CITY'S CODE OF ORDINANCES PRESENTLY PROVIDES THAT PERMITS FOR BEACH COMMERCE ARE ISSUED BY THE POLICE DEPARTMENT, THE RESOLUTION ALSO DIRECTS THAT DEPARTMENT TO WITHHOLD THE ISSUANCE OF PERMITS TO BEACH SERVICES OR OWNER OPERATORS WHO DO NOT REMOVE THEIR WOODEN LOUNGERS FROM THE BEACH BY OCTOBER 31, 2019. LASTLY, THE RESOLUTION DIRECTS THE CITY MANAGER TO NOTIFY BEACH BUSINESSES AND APPLICANTS OF THE CITY'S DIRECTION REGARDING THE WOODEN LOUNGERS.

THE RESOLUTION IS AVAILABLE FOR CONSIDERATION AND APPROVAL.

RESOLUTION 18-36

A RESOLUTION OF THE CITY OF PANAMA CITY BEACH RELATED TO BEACH CHAIRS, PROVIDING THAT WOODEN LOUNGERS SHALL NOT BE PERMITTED TO BE STORED ON THE BEACH OVERNIGHT AFTER OCTOBER 31, 2019; AUTHORIZING THE POLICE DEPARTMENT TO WITHHOLD OR REVOKE PERMITS FOR BEACH SERVICES OR OWNER OPERATORS WHO DO NOT REMOVE FROM THE BEACH OR ORDERLY STORE AT THE TOW OF THE DUNE BEACH CHAIRS AFTER OCTOBER 31, 2019; PROVIDING THAT NOTICE OF THIS RESOLUTION SHALL BE PROVIDED TO VENDORS OF BEACH COMMERCE; AND PROVIDING AN IMMEDIATELY EFFECTIVE DATE.

Whereas, the City Council recognizes the white sandy beaches are the City's most valuable natural resource, and have enunciated a desire to keep the beach free of obstructions that impede both beach cleaning and raking equipment; and

Whereas, the Council desires to see the heavy wooden loungers replaced as soon as possible with lighter, more transportable beach chairs that can be carried off the beach or to the tow of the dune each night, but recognizes that beach vendors often use those wooden loungers for several consecutive seasons in order to recoup their investments in the loungers; and

Whereas, the Council finds and determines that allowing beach vendors two more full seasons to use the wooden loungers will fairly balance the Council's desire to keep the beaches free from obstruction against the beach vendors' desire to recoup their investment in the wooden loungers.

NOW THEREFORE BE IT RESOLVED BY THE CITY COUNCIL OF THE CITY OF PANAMA CITY BEACH, FLORIDA, that:

1. After October 31, 2019, the City Manager shall not be authorized to permit the overnight storage of wooden loungers on the beach.¹
2. After October 31, 2019, the Chief of Police is authorized and directed to withhold issuance of permits to engage in Beach Commerce or Limited Beach

¹ Section 7-124 of the City Code of Ordinances, authorizes the City manager to issue permit the overnight storage of items that are adjunct to a lawfully existing activity generally and for beach businesses or beach services specifically.

Commerce or recommend for revocation or suspension permits validly issued, as appropriate, to vendors of beach chairs and loungers who, on any date after October 31, 2019, do not remove those beach chairs or loungers from the beach or store them lawfully and orderly at the tow of the dune each night.

3. On or before December 31, 2017, the City Manager shall provide a copy of this Resolution to all Beach Services and Owner Operators currently permitted by the City to engage in Beach Commerce to notify them of the City Council's action and intention, and thereafter make available a copy of this Resolution to all persons applying to the City to engage in Beach Commerce.

This Resolution shall take effect immediately upon passage.

PASSED, APPROVED AND ADOPTED at the regular meeting of the City Council of the City of Panama City Beach, Florida, this 14th day of December, 2017.

CITY OF PANAMA CITY BEACH

By: _____
Mike Thomas, Mayor

ATTEST:

Jo Smith, City Clerk